

**SITAC® AC Switches  
Without Zero Voltage Switch**

- AC switch without zero-voltage detector
- Electrically insulated between input and output circuit
- Microcomputer-compatible by very low trigger current
- UL-tested (file no. E 52744), code letter "J"
- Available with the following options:  
 Option 1: VDE 0884-approved  
 Option 6: Pins in 10.16 mm spacing  
 Option 7: Pins for surface mounting

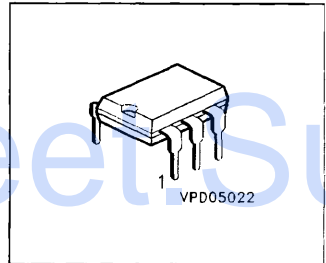

Type	Opt.	V <sub>DRM</sub>	I <sub>TRMS</sub>	I <sub>FT</sub>	dV/dt <sub>CI</sub>	Marking	Odering Code
BRT 11 H	-	400 V	300 mA	2 mA	10 kV/μs	BRT 11 H	C67079-A1000-A6
BRT 11 M	-	400 V	300 mA	3 mA	10 kV/μs	BRT 11 M	C67079-A1000-A10
BRT 12 H	-	600 V	300 mA	2 mA	10 kV/μs	BRT 12 H	C67079-A1001-A6
BRT 12 H	1	600 V	300 mA	2 mA	10 kV/μs	BRT 12 H	C67079-A1041-A5
BRT 12 H	6	600 V	300 mA	2 mA	10 kV/μs	BRT 12 H	C67079-A1041-A8
BRT 12 H	7	600 V	300 mA	2 mA	10 kV/μs	BRT 12 H	C67079-A1041-A11
BRT 12 H	1 + 6	600 V	300 mA	2 mA	10 kV/μs	BRT 12 H	C67079-A1041-A14
BRT 12 M	-	600 V	300 mA	3 mA	10 kV/μs	BRT 12 M	C67079-A1001-A10
BRT 12 M	1	600 V	300 mA	3 mA	10 kV/μs	BRT 12 M	C67079-A1041-A6
BRT 13 H	-	800 V	300 mA	2 mA	10 kV/μs	BRT 13 H	C67079-A1002-A6
BRT 13 H	6	800 V	300 mA	2 mA	10 kV/μs	BRT 13 H	C67079-A1042-A8
BRT 13 H	7	800 V	300 mA	2 mA	10 kV/μs	BRT 13 H	C67079-A1042-A11
BRT 13 M	-	800 V	300 mA	3 mA	10 kV/μs	BRT 13 M	C67079-A1002-A10

Information	Package	Pin Configuration					
		1	2	3	4	5	6
50 pcs per tube	P-DIP-6	Anode	Kathode	not connected	A1	do not connect	A2

**Maximum Ratings**, at  $T_j = 25\text{ °C}$ , unless otherwise specified.

### AC Switch

Parameter	Symbol	Value	Unit
Max. Power dissipation	$P_{tot}$	630	mW
Chip or operating temperature	$T_j$	-40 ...+ 100	°C
Storage temperature	$T_{stg}$	-40 ...+ 150	
Insulation test voltage 1) between input/output circuit (climate in acc. with DIN 40 046, part 2, Nov. 74)	$V_{IS}$	5300	$V_{RMS}$
Reference voltage in acc. with VDE 0110 b (insulation group C)	$V_{ref}$	500 600	$V_{RMS}$ $V_{DC}$
Creepage tracking resistance (in acc. with DIN IEC 112/VDE 0303, part 1)	$C_{TI}$	175	(group IIIa acc. to DIN VDE 0109)
Insulation resistance $V_{IO} = 500\text{ V}$ , $T_A = 25\text{ °C}$ $V_{IO} = 500\text{ V}$ , $T_A = 100\text{ °C}$	$R_{is}$	$\geq 10^{12}$ $\geq 10^{11}$	$\Omega$
DIN humidity category, DIN 40 040		F	
Creepage distance (input/output circuit)	-	$\geq 7.2$	mm
Clearance (input/output circuit)	-	$\geq 7.2$	

### Input Circuit

Parameter	Symbol	Value	Unit
Param VR	$V_R$	6	V
Continuous forward current	$I_F$	20	mA
Surge forward current,	$I_{FSM(I)}$	1.5	A
Max. power dissipation, $t \leq 10\text{ }\mu\text{s}$	$P_{tot}$	30	mW

### Output Circuit

Parameter	Symbol	BRT	BRT	BRT	Unit
		11	12	13	
Repetitive peak off-state voltage	$V_{DRM}$	400	600	800	V
RMS on-state current	$I_{TRMS}$	300			mA
Single cycle surge current (50 Hz)	$I_{TSM(I)}$	3			A
Max. power dissipation	$P_{tot}$	600			mW

## Characteristics

at  $T_j = 25\text{ °C}$ , unless otherwise specified.

### Input Circuit

Parameter	Symbol	Values			Unit
		min.	typ.	max.	
Forward Voltage, $I_F = 10\text{ mA}$	$V_F$	-	1.1	1.35	V
Reverse current, $V_R = 6\text{ V}$	$I_R$	-	-	10	$\mu\text{A}$
Thermal resistance 1) junction - ambient	$R_{thJA}$	-	-	750	K/W

### Electrical Characteristics

Parameter	Symbol	Values			Unit
		min.	typ.	max.	
Critical rate of rise of off-state voltage $V_D = 0.67 V_{DRM}$ $T_j = 25\text{ °C}$ $T_j = 80\text{ °C}$	$dv/dt_{cr}$	10 5	- -	- -	kV/ $\mu\text{s}$
Critical rate of rise of voltage at current commutation $V_D = 0.67 V_{DRM}$ , $di/dt_{crq} \leq 15\text{ A/ms}$ $T_j = 25\text{ °C}$ $T_j = 80\text{ °C}$	$dv/dt_{crq}$	10 5	- -	- -	
Critical rate of rise of on-state current	$di/dt_{cr}$	8	-		A/ $\mu\text{s}$
Pulse current $t_p \leq 5\text{ }\mu\text{s}$ , $f = 100\text{ Hz}$ , $di_p/dt \leq 8\text{ A}/\mu\text{s}$	$I_p$			2	A
On-state voltage, $I_T = 300\text{ mA}$	$V_T$			2.3	V
Off-state current, $T_C = 100\text{ °C}$ , $V_{DRM}$	$I_D$	-	0.5	100	$\mu\text{A}$
Holdin current, $V_D = 10\text{ V}$	$I_H$		80	500	
Thermal resistance 2) junction - ambient	$R_{thJA}$			125	K/W

### Response Characteristics

at  $T_j = 25\text{ °C}$ , unless otherwise specified.

Parameter	Symbol	Values			Unit
		min.	typ.	max.	
Trigger current $V_D = 10\text{ V}$ type H type M	$I_{FT}$	0.4 0.4	- -	2.0 3.0	mA
Trigger current temperature gradient	$\Delta I_{FT} / \Delta T_j$	-	7	14	$\mu\text{A/K}$
Capacitance between input and output circuit $V_R = 0\text{ V}$ , $f = 1\text{ kHz}$	$C_{IO}$	-	-	2	pF

- 1) Test AC voltage in acc. with DIN 57883, June 1980.
- 2) Static air, SITAC soldered in pcb or base plate.
- 3) The SITAC switch is soldered in pcb or base plate.
- 4) Thermocouple measurement has to be performed potentially separated to A1 and A2. The measuring junction should be as near as possible at the case.

## Package Outline

### P-DIP-6

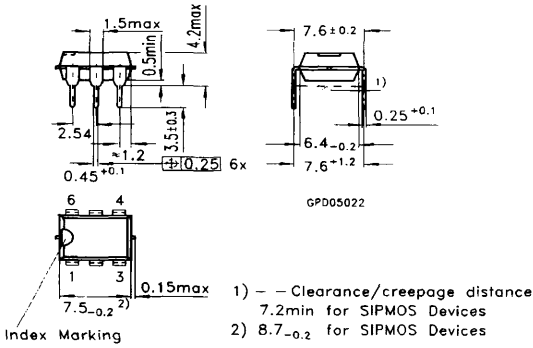

### Option 6

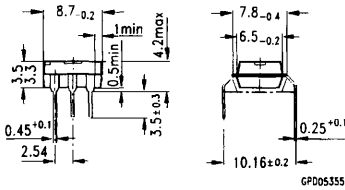

--- Clearance-/creepage distance 8.0 min.

### Option 7

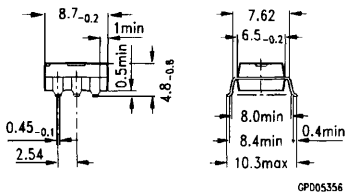

--- Clearance-/creepage distance 8.0 min.

Dimensions in mm

Clearance and creepage distances must be taken into account for the solder powl design.

### Characteristics

at  $T_j = 25^\circ\text{C}$ , unless otherwise specified.

#### Typical input characteristics

$$I_F = f(V_F)$$

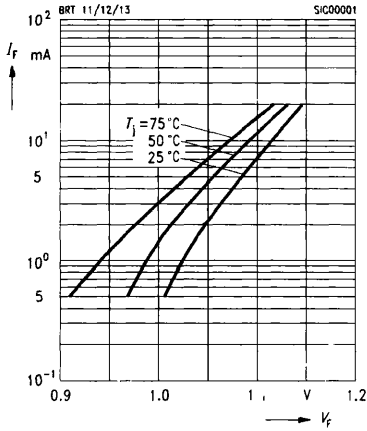

#### Typical output characteristics

$$I_T = f(V_T)$$

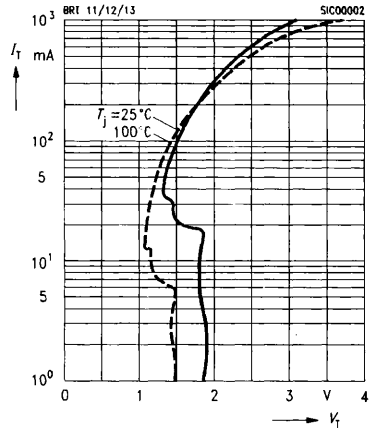

#### Current reduction $I_{TRMS} = f(T_A)$

$$R_{thJA} = 125 \text{ K/W}^3)$$

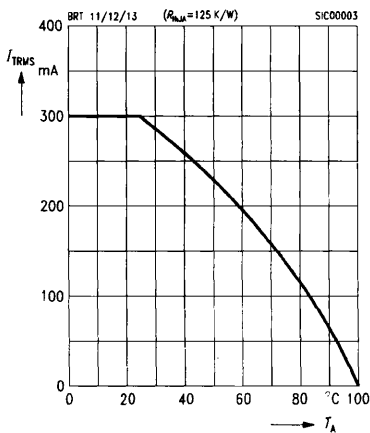

#### Current reduction $I_{TRMS} = f(T_{PIN5})$

$$R_{thJ-PIN5} = 16,5 \text{ K/W}^4)$$

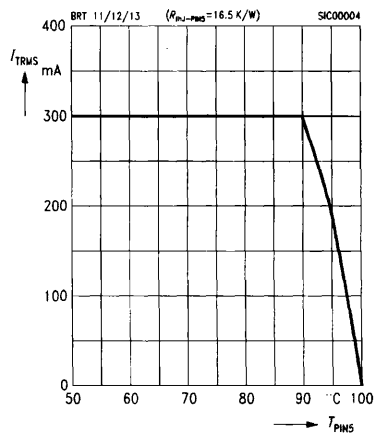

**Typ trigger delay time**  $t_{gd} = f(f / f_{T25} \text{ } ^\circ\text{C})$   
 $V_D = 200 \text{ V}$

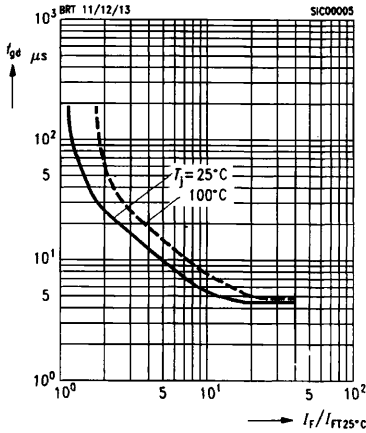

**Power dissipation for 40 ... 60 Hz line operation**  
 $P_{tot} = f(I_{TRMS})$

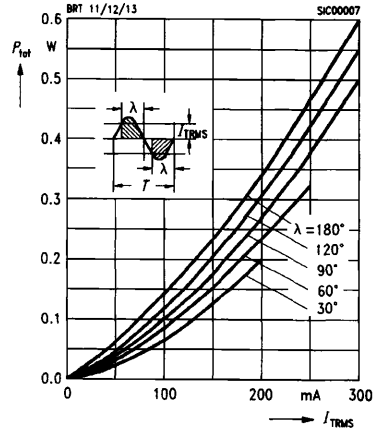

**Typ. off-state current**  $I_D = f(T_j)$   
 $V_D = 800 \text{ V}$

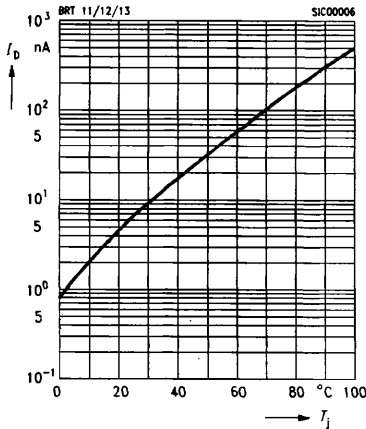

**Pulse trigger current**  $I_{FTN} = f(t_{PIF})$   
 $I_{FTN}$  normalized to  $I_{FT}$  referring to  $t_{PIF} \geq 1 \text{ ms}$   
 $V_{OD} = 220 \text{ V}$ ,  $f = 40 \dots 60 \text{ Hz typ.}$

