

Agilent T-1³/₄ (5 mm) High Intensity LED Lamps

Data Sheet

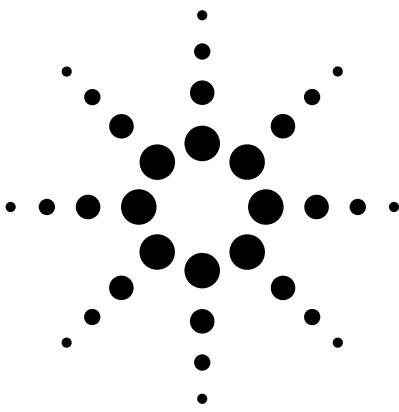

HLMP-331x Series, HLMP-341x Series, HLMP-351x Series

Description

This family of T-1³/₄ nondiffused LED lamps is specially designed for applications requiring higher on-axis intensity than is achievable with a standard lamp. The light generated is focused to a narrow beam to achieve this effect.

Features

- High intensity
- Choice of 3 bright colors
High Efficiency Red
Yellow
High Performance Green
- Popular T-1³/₄ diameter package
- Selected minimum intensities
- Narrow viewing angle
- General purpose leads
- Reliable and rugged
- Available on tape and reel

Selection Guide

Color	Part Number	Luminous Intensity I _v (mcd) @ 10 mA	
		Min.	Max.
Red	HLMP-3315	13.8	-
	HLMP-3317	22.00	-
	HLMP-3316-I00xx	22.0	-
	HLMP-3316-IJ0xx	22.0	70.4
Yellow	HLMP-3415	9.2	-
	HLMP-3416	14.7	-
	HLMP-3416-G00xx	14.7	-
	HLMP-3416-IJ0xx	37.6	120.2
Green	HLMP-3517	6.7	-
	HLMP-3519	10.6	-
	HLMP-3519-F00xx	10.6	-
	HLMP-3519-IJ0xx	43.6	139.6



Part Numbering System

HLMP - 3 x 1 x - x x x xx

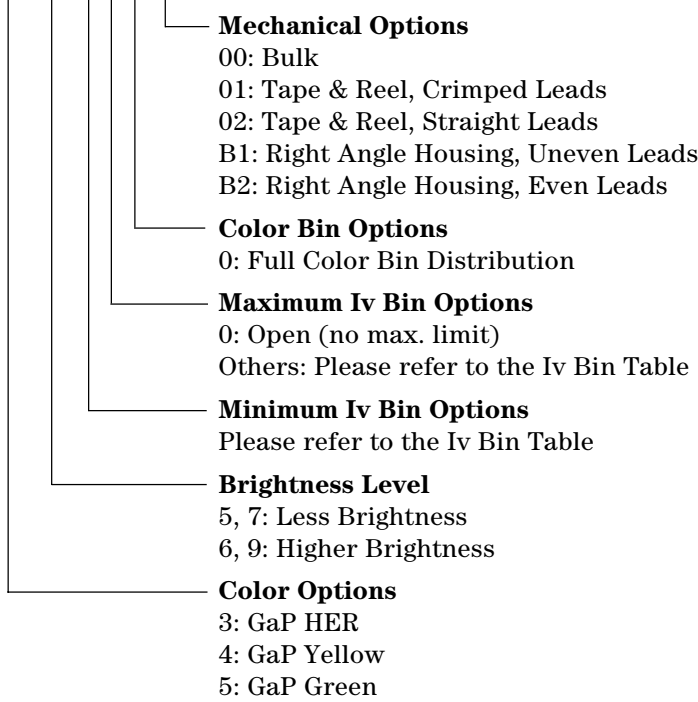

Package Dimensions

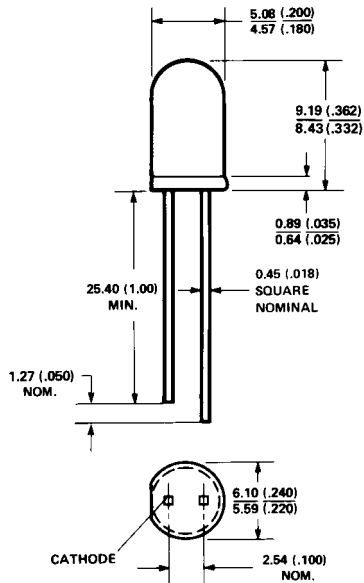

NOTES:
 1. ALL DIMENSIONS ARE IN MILLIMETRES (INCHES).
 2. AN EPOXY MENISCUS MAY EXTEND ABOUT 1mm (.040") DOWN THE LEADS.

Electrical Characteristics at $T_A = 25^\circ\text{C}$

Symbol	Description	Device HLMP-	Min.	Typ.	Max.	Units	Test Conditions
I_V	Luminous Intensity	3315	13.8	40.0		mcd	$I_F = 10\text{ mA}$ (Figure 3)
		3316	22	60.0			
		3415	9.2	40.0		mcd	$I_F = 10\text{ mA}$ (Figure 8)
		3416	14.7	50.0			
		3517	6.7	50.0		mcd	$I_F = 10\text{ mA}$ (Figure 13)
$2\theta_{1/2}$	Including Angle Between Half Luminous Intensity Points	3315		35		Deg.	$I_F = 10\text{ mA}$ See Note 1 (Figure 6)
		3316		35			
		3415		35		Deg.	$I_F = 10\text{ mA}$ See Note 1 (Figure 11)
		3416		35			
		3517		24		Deg.	$I_F = 10\text{ mA}$ See Note 1 (Figure 16)
λ_{PEAK}	Peak Wavelength	331X		635		nm	Measurement at Peak (Figure 1)
		341X		583			
		351X		565			
$\Delta\lambda_{1/2}$	Spectral Line Halfwidth	331X		40		nm	
		341X		36			
		351X		28			
λ_d	Dominant Wavelength	331X		626		nm	See Note 2 (Figure 1)
		341X		585			
		351X		569			
τ_s	Speed of Response	331X		90		ns	
		341X		90			
		351X		500			
C	Capacitance	331X		11		pF	$V_F = 0$; $f = 1\text{ MHz}$
		341X		15			
		351X		18			
$R\theta_{J-PIN}$	Thermal Resistance	331X		260		$^\circ\text{C}/\text{W}$	Junction to Cathode Lead
		341X					
		351X					
V_F	Forward Voltage	331X		1.9	2.4	V	$I_F = 10\text{ mA}$ (Figure 2)
		341X		2.0	2.4		$I_F = 10\text{ mA}$ (Figure 7)
		351X		2.1	2.7		$I_F = 10\text{ mA}$ (Figure 12)
V_R	Reverse Breakdown Volt.	All	5.0			V	$I_R = 100\text{ }\mu\text{A}$
η_V	Luminous Efficacy	331X		145		$\frac{\text{lumens}}{\text{Watt}}$	See Note 3
		341X		500			
		351X		595			

Notes:

- $\theta_{1/2}$ is the off-axis angle at which the luminous intensity is half the axial luminous intensity.
- The dominant wavelength, λ_d , is derived from the CIE chromaticity diagram and represents the single wavelength which defines the color of the device.
- Radiant intensity, I_e , in watts/steradian, may be found from the equation $I_e = I_V/\eta_V$, where I_V is the luminous intensity in candelas and η_V is the luminous efficacy in lumens/watt.

Absolute Maximum Ratings at $T_A = 25^\circ\text{C}$

Parameter	331X Series	341X Series	351X Series	Units
Peak Forward Current	90	60	90	mA
Average Forward Current ^[1]	25	20	25	mA
DC Current ^[2]	30	20	30	mA
Power Dissipation ^[3]	135	85	135	mW
Reverse Voltage ($I_R = 100 \mu\text{A}$)	5	5	5	V
Transient Forward Current ^[4] (10 μsec Pulse)	500	500	500	mA
LED Junction Temperature	110	110	110	$^\circ\text{C}$
Operating Temperature Range	-55 to +100	-55 to +100	-20 to +100	$^\circ\text{C}$
Storage Temperature Range			-55 to +100	

Notes:

1. See Figure 5 (Red), 10 (Yellow), or 15 (Green) to establish pulsed operating conditions.
2. For Red and Green series derate linearly from 50°C at $0.5 \text{ mA}/^\circ\text{C}$. For Yellow series derate linearly from 50°C at $0.2 \text{ mA}/^\circ\text{C}$.
3. For Red and Green series derate power linearly from 25°C at $1.8 \text{ mW}/^\circ\text{C}$. For Yellow series derate power linearly from 50°C at $1.6 \text{ mW}/^\circ\text{C}$.
4. The transient peak current is the maximum non-recurring peak current that can be applied to the device without damaging the LED die and wirebond.
It is not recommended that the device be operated at peak currents beyond the peak forward current listed in the Absolute Maximum Ratings.

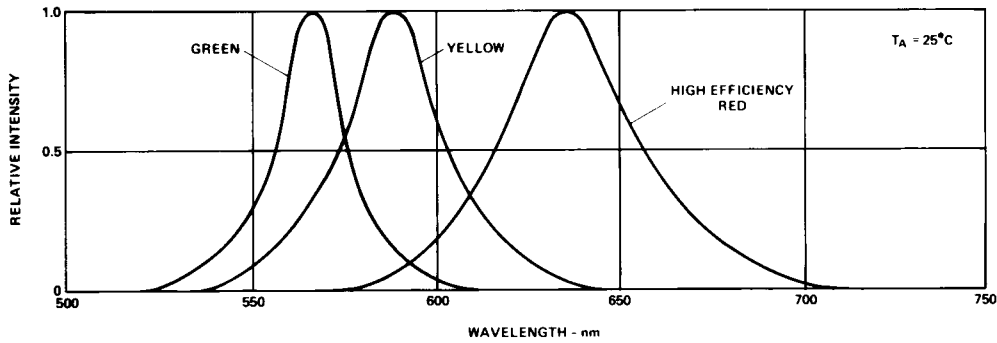

Figure 1. Relative intensity vs. wavelength.

High Efficiency Red HLMP-331X Series

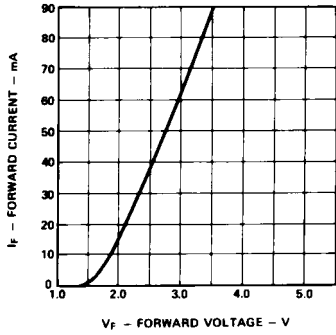

Figure 2. Forward current vs. forward voltage characteristics.

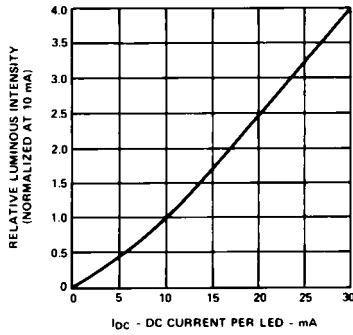

Figure 3. Relative luminous intensity vs. DC forward current.

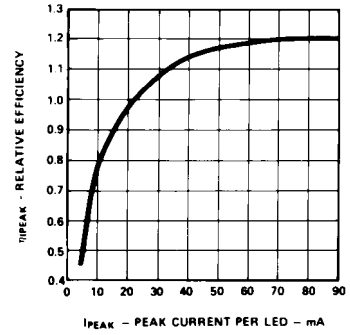

Figure 4. Relative efficiency (luminous intensity per unit current) vs. peak LED current.

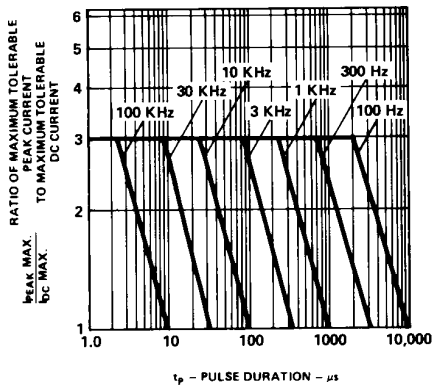

Figure 5. Maximum tolerable peak current vs. pulse duration ($I_{DC\ MAX}$ as per MAX ratings).

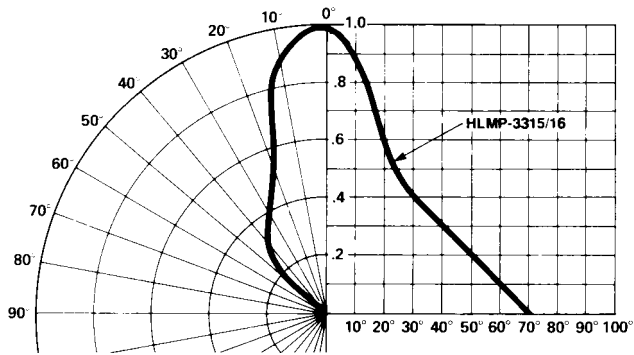

Figure 6. Relative luminous intensity vs. angular displacement.

Yellow HLMP-341X Series

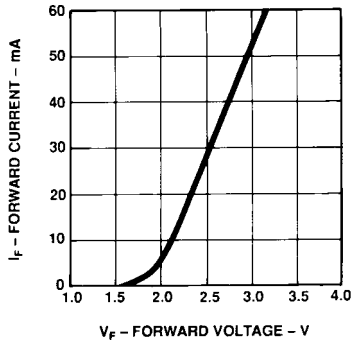

Figure 7. Forward current vs. forward voltage characteristics.

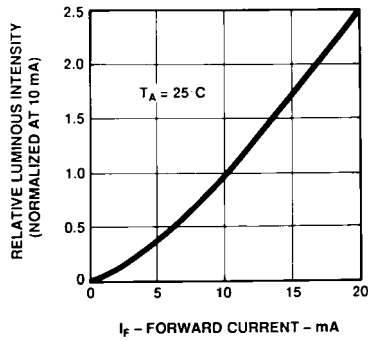

Figure 8. Relative luminous intensity vs. DC forward current.

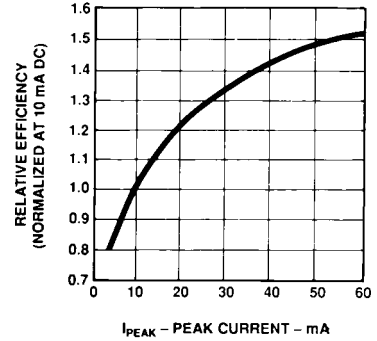

Figure 9. Relative efficiency (luminous intensity per unit current) vs. peak current.

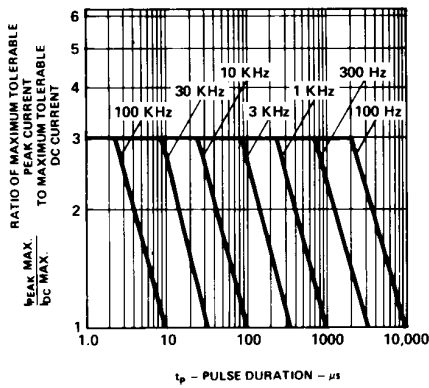

Figure 10. Maximum tolerable peak current vs. pulse duration (I_{DC} MAX as per MAX ratings).

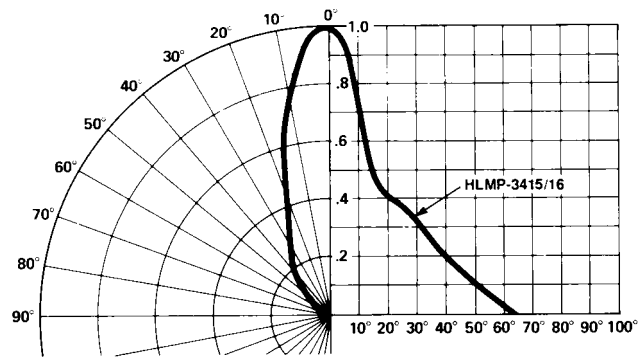

Figure 11. Relative luminous intensity vs. angular displacement.

Green HLMP-351X Series

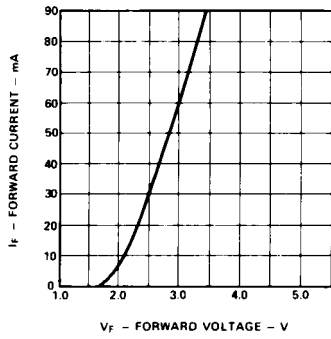

Figure 12. Forward current vs. forward voltage characteristics.

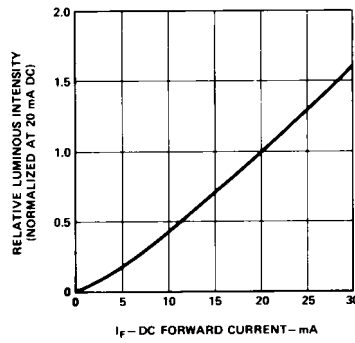

Figure 13. Relative luminous intensity vs. DC forward current.

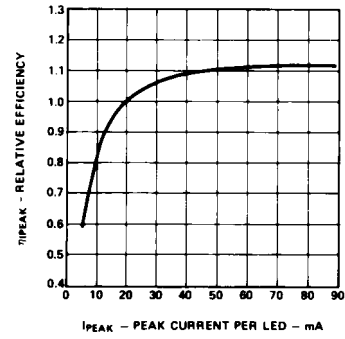

Figure 14. Relative efficiency (luminous intensity per unit current) vs. peak LED current.

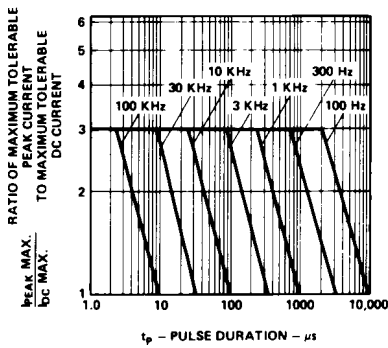

Figure 15. Maximum tolerable peak current vs. pulse duration (I_{DC} MAX as per MAX ratings).

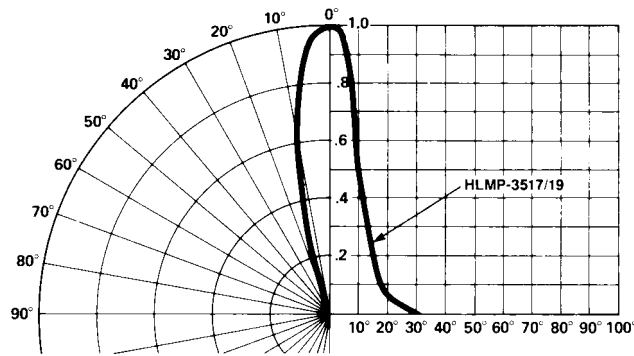

Figure 16. Relative luminous intensity vs. angular displacement. T-1³/₄ lamp.

Table 2. Intensity Bin Limit

Color	Bin	Intensity Range (mcd)	
		Min.	Max.
Red	H	15.5	24.8
	I	24.8	39.6
	J	39.6	63.4
	K	63.4	101.5
	L	101.5	162.4
	M	162.4	234.6
	N	234.6	340.0
	O	340.0	540.0
	P	540.0	850.0
	Q	850.0	1200.0
	R	1200.0	1700.0
	S	1700.0	2400.0
	T	2400.0	3400.0
	U	3400.0	4900.0
	V	4900.0	7100.0
	W	7100.0	10200.0
	X	10200.0	14800.0
	Y	14800.0	21400.0
Z	21400.0	30900.0	

Table 2. (Cont'd)

Color	Bin	Intensity Range (mcd)	
		Min.	Max.
Yellow	G	16.6	26.5
	H	26.5	42.3
	I	42.3	67.7
	J	67.7	108.2
	K	108.2	173.2
	L	173.2	250.0
	M	250.0	360.0
	N	360.0	510.0
	O	510.0	800.0
	P	800.0	1250.0
	Q	1250.0	1800.0
	R	1800.0	2900.0
	S	2900.0	4700.0
	T	4700.0	7200.0
	U	7200.0	11700.0
	V	11700.0	18000.0
	W	18000.0	27000.0

Table 2. (Cont'd)

Color	Bin	Intensity Range (mcd)	
		Min.	Max.
Green	E	7.6	12.0
	F	12.0	19.1
	G	19.1	30.7
	H	30.7	49.1
	I	49.1	78.5
	J	78.5	125.7
	K	125.7	201.1
	L	201.1	289.0
	M	289.0	417.0
	N	417.0	680.0
	O	680.0	1100.0
	P	1100.0	1800.0
	Q	1800.0	2700.0
	R	2700.0	4300.0
	S	4300.0	6800.0
	T	6800.0	10800.0
	U	10800.0	16000.0
	V	16000.0	25000.0
W	25000.0	40000.0	

Maximum tolerance for each bin limit is $\pm 18\%$.

Color Categories

Color	Cat #	Lambda (nm)	
		Min.	Max.
Green	6	561.5	564.5
	5	564.5	567.5
	4	567.5	570.5
	3	570.5	573.5
	2	573.5	576.5
	1	582.0	584.5
Yellow	3	584.5	587.0
	2	587.0	589.5
	4	589.5	592.0
	5	592.0	593.0

Mechanical Option Matrix

Mechanical Option Code	Definition
00	Bulk Packaging, minimum increment 500 pcs/bag
01	Tape & Reel, crimped leads, minimum increment 1300 pcs/bag
02	Tape & Reel, straight leads, minimum increment 1300 pcs/bag
B1	Right Angle Housing, uneven leads, minimum increment 500 pcs/bag
B2	Right Angle Housing, even leads, minimum increment 500 pcs/bag

Note:

All Categories are established for classification of products. Products may not be available in all categories. Please contact your local Agilent representative for further clarification/information.

Precautions

Lead Forming

- The leads of an LED lamp may be preformed or cut to length prior to insertion and soldering into PC board.
- If lead forming is required before soldering, care must be taken to avoid any excessive mechanical stress induced to LED package. Otherwise, cut the leads of LED to length after soldering process at room temperature. The solder joint formed will absorb the mechanical stress of the lead cutting from traveling to the LED chip die attach and wirebond.
- It is recommended that tooling made to precisely form and cut the leads to length rather than rely upon hand operation.

Soldering Conditions

- Care must be taken during PCB assembly and soldering process to prevent damage to LED component.
- The closest LED is allowed to solder on board is 1.59 mm below the body (encapsulant epoxy) for those parts without standoff.
- Recommended soldering conditions:

	Wave Soldering	Manual Solder Dipping
Pre-heat Temperature	105 °C Max.	–
Pre-heat Time	30 sec Max.	–
Peak Temperature	250 °C Max.	260 °C Max.
Dwell Time	3 sec Max.	5 sec Max.

- Wave soldering parameter must be set and maintained according to recommended temperature and dwell time in the solder wave. Customer is advised to periodically check on the soldering profile to ensure the soldering profile used is always conforming to recommended soldering condition.
- If necessary, use fixture to hold the LED component in proper orientation with respect to the PCB during soldering process.
- Proper handling is imperative to avoid excessive thermal stresses to LED components when heated. Therefore, the soldered PCB must be allowed to cool to room temperature, 25°C, before handling.
- Special attention must be given to board fabrication, solder masking, surface plating and lead holes size and component orientation to assure solderability.
- Recommended PC board plated through hole sizes for LED component leads:

LED Component Lead Size	Diagonal	Plated Through Hole Diameter
0.457 x 0.457 mm (0.018 x 0.018 inch)	0.646 mm (0.025 inch)	0.976 to 1.078 mm (0.038 to 0.042 inch)
0.508 x 0.508 mm (0.020 x 0.020 inch)	0.718 mm (0.028 inch)	1.049 to 1.150 mm (0.041 to 0.045 inch)

Note: Refer to application note AN1027 for more information on soldering LED components.

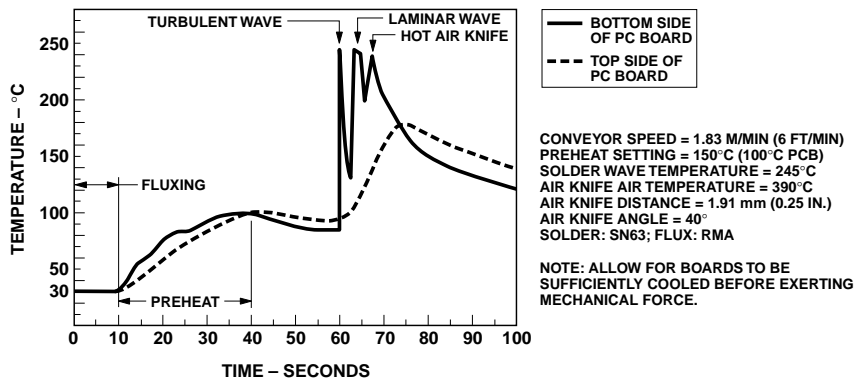

Figure 17. Recommended wave soldering profile.

www.agilent.com/semiconductors

For product information and a complete list of distributors, please go to our web site.

For technical assistance call:

Americas/Canada: +1 (800) 235-0312 or (916) 788-6763

Europe: +49 (0) 6441 92460

China: 10800 650 0017

Hong Kong: (+65) 6756 2394

India, Australia, New Zealand: (+65) 6755 1939

Japan: (+81 3) 3335-8152(Domestic/International), or 0120-61-1280(Domestic Only)

Korea: (+65) 6755 1989

Singapore, Malaysia, Vietnam, Thailand, Philippines, Indonesia: (+65) 6755 2044

Taiwan: (+65) 6755 1843

Data subject to change.

Copyright © 2005 Agilent Technologies, Inc.

Obsoletes 5988-2146EN

November 16, 2005

5989-4259EN



Agilent Technologies