



Major Ratings and Characteristics

Characteristics	Value	Units
$I_{F(AV)}$ (DC)	0.5	A
V_{RRM}	30	V
I_{FSM} @ $t_p = 10\text{ms}$ sine	10	A
V_F @ $0.5A_{pk}, T_J = 125^\circ\text{C}$	0.35	V
T_J range	- 65 to 150	$^\circ\text{C}$

Description/ Features

This Schottky diode is ideally suited for low voltage, high frequency operation, as freewheeling and polarity protection. Small size of the package allows proper use in application where compact size is critical, fitting also the GSM and PCMCIA requirement.

- Surface mountable
- Very low forward voltage drop
- Extremely fast switching
- Negligible switching losses
- Guard ring for enhanced ruggedness and long term reliability

Database Support

Case Styles

Device Marking: IR530

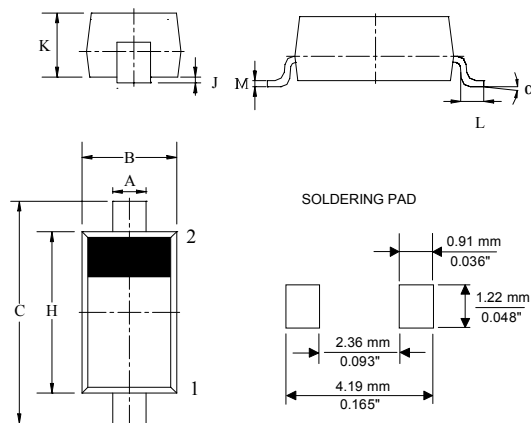

DIM	Millimeters		Inches	
	Min	Max	Min	Max
A	0.55	0.70	0.022	0.028
B	1.40	1.70	0.055	0.067
C	3.55	3.85	0.140	0.152
H	2.55	2.85	0.100	0.112
J	-	0.10	-	0.004
K	0.95	1.35	0.037	0.053
L	-	1.35	-	0.053
M	-	0.15	-	0.006
α	8 $^\circ$		8 $^\circ$	



Voltage Ratings

Part number	Value
V _R Max. DC Reverse Voltage (V)	30
V _{RWM} Max. Working Peak Reverse Voltage (V)	

Absolute Maximum Ratings

Parameters	Value	Units	Conditions	
I _F Forward Current	0.5	A	DC, T _L = 126°C	
I _{FSM} Max. Peak One Cycle Non-Repetitive Surge Current, @T _J =25°C	75	A	5µs Sine or 3µs Rect. pulse	Following any rated load condition and with rated V _{RWM} applied
	10	A	10ms Sine or 6ms Rect. pulse	

Electrical Specifications

Parameters	Value	Units	Conditions	
V _{FM} Max. Forward Voltage Drop (1)	0.375	V	@ 0.1A	T _J = 25°C
	0.430	V	@ 0.5A	
V _{FM} Max. Forward Voltage Drop (1)	0.250	V	@ 0.1A	T _J = 125 °C
	0.350	V	@ 0.5A	
I _{RM} Max. Reverse Leakage Current	20	µA	V _R = 15V	T _J = 25°C
	130	µA	V _R = 30V	
C _T Max. Junction Capacitance	90	pF	V _R = 5V _{DC} (test signal range 100KHz to 1Mhz), T _J = 25°C	
dv/dt Max. Voltage Rate of Change (Rated V _R)	10000	V/µs		

(1) Pulse Width < 300µs, Duty Cycle < 2%

Thermal-Mechanical Specifications

Parameters	Value	Units	Conditions
T _J Max. Junction Temperature Range (*)	-65 to 150	°C	
T _{stg} Max. Storage Temperature Range	-65 to 150	°C	
R _{th(j-l)} Max. Thermal Resistance Junction to Lead	150	°C/W	Mounted on PC board FR4 with minimum pad size
R _{th(j-a)} Max. Thermal Resistance Junction to Ambient	200	°C/W	1 inch square pad size (1 x 0.5 inch for each lead) on FR4 board
Wt Approximate Weight	0.012	gr	
Case Style	SOD123		
Device Marking	IR530		

(*) $\frac{dP_{tot}}{dT_J} < \frac{1}{R_{th(j-a)}}$ thermal runaway condition for a diode on its own heatsink

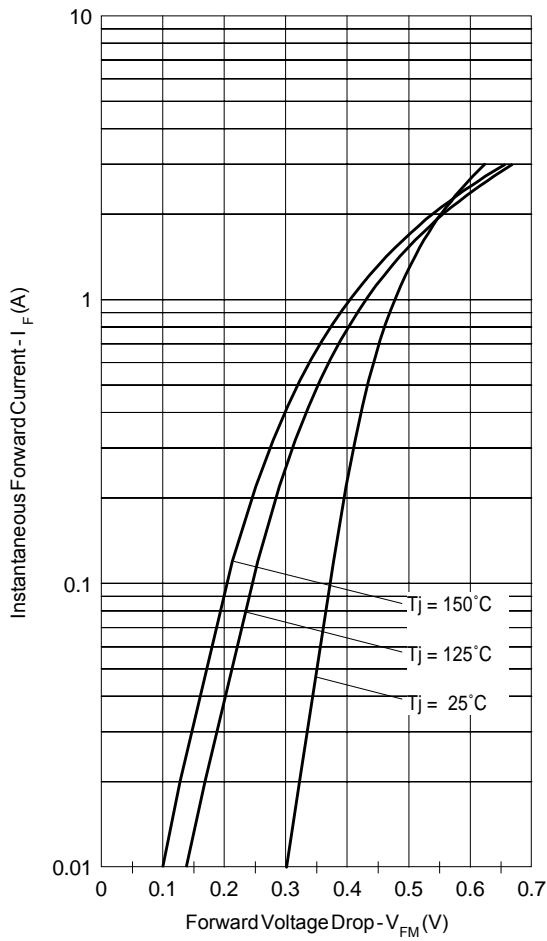

Fig. 1 - Max. Forward Voltage Drop Characteristics (Per Leg)

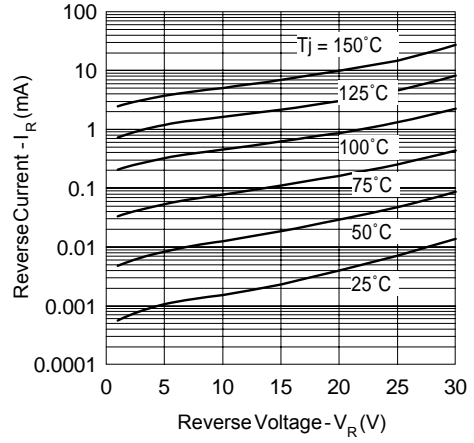

Fig. 2 - Typical Values Of Reverse Current Vs. Reverse Voltage (Per Leg)

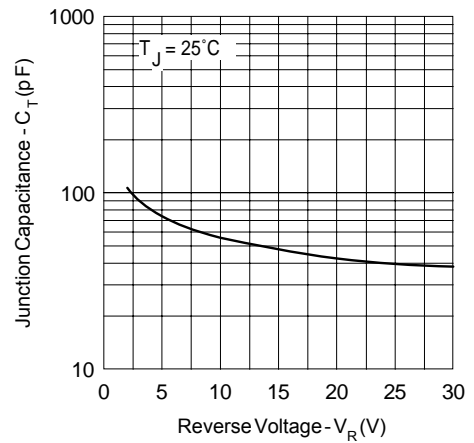

Fig. 3 - Typical Junction Capacitance Vs. Reverse Voltage (Per Leg)

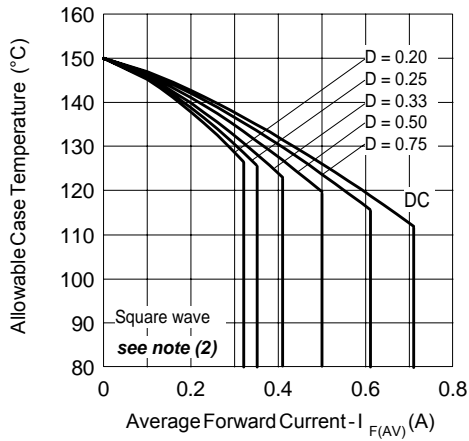

Fig. 4 - Max. Allowable Case Temperature Vs. Average Forward Current

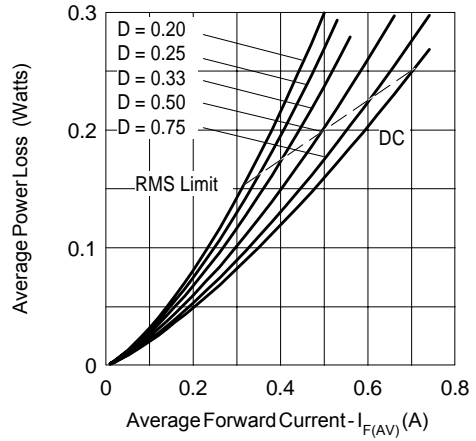

Fig. 5 - Forward Power Loss Characteristics

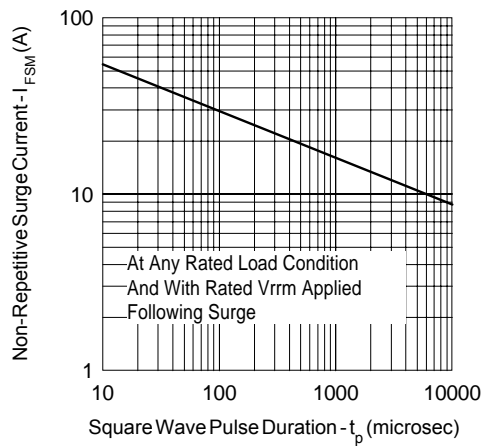
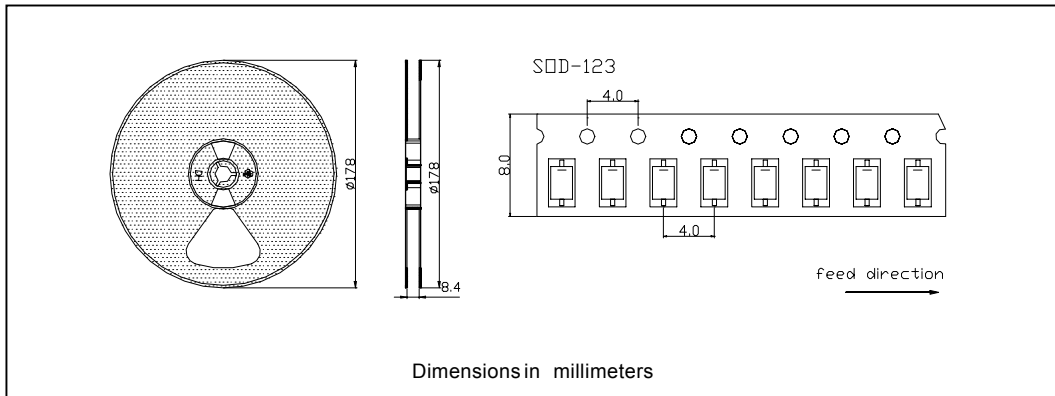

Fig. 6 - Max. Non-Repetitive Surge Current

(2) Formula used: $T_C = T_J - Pd \times R_{thJC}$;
 $Pd = \text{Forward Power Loss} = I_{F(AV)} \times V_{FM} @ (I_{F(AV)}/D)$ (see Fig. 4)

Tape & Reel Information



Ordering Information Table

Device	Package	Marking	Base qty	Delivery mode
MBR0530	SOD-123	IR530	3000	Tape & Reel

Data and specifications subject to change without notice.
 This product has been designed for Industrial Level.
 Qualification Standards can be found on IR's Web site.