



Is Now Part of



Datasheet Support

**ON Semiconductor®**

To learn more about ON Semiconductor, please visit our website at  
[www.onsemi.com](http://www.onsemi.com)

Please note: As part of the Fairchild Semiconductor integration, some of the Fairchild orderable part numbers will need to change in order to meet ON Semiconductor's system requirements. Since the ON Semiconductor product management systems do not have the ability to manage part nomenclature that utilizes an underscore (\_), the underscore (\_) in the Fairchild part numbers will be changed to a dash (-). This document may contain device numbers with an underscore (\_). Please check the ON Semiconductor website to verify the updated device numbers. The most current and up-to-date ordering information can be found at [www.onsemi.com](http://www.onsemi.com). Please email any questions regarding the system integration to [Fairchild\\_questions@onsemi.com](mailto:Fairchild_questions@onsemi.com).

ON Semiconductor and the ON Semiconductor logo are trademarks of Semiconductor Components Industries, LLC dba ON Semiconductor or its subsidiaries in the United States and/or other countries. ON Semiconductor owns the rights to a number of patents, trademarks, copyrights, trade secrets, and other intellectual property. A listing of ON Semiconductor's product/patent coverage may be accessed at [www.onsemi.com/site/pdf/Patent-Marking.pdf](http://www.onsemi.com/site/pdf/Patent-Marking.pdf). ON Semiconductor reserves the right to make changes without further notice to any products herein. ON Semiconductor makes no warranty, representation or guarantee regarding the suitability of its products for any particular purpose, nor does ON Semiconductor assume any liability arising out of the application or use of any product or circuit, and specifically disclaims any and all liability, including without limitation special, consequential or incidental damages. Buyer is responsible for its products and applications using ON Semiconductor products, including compliance with all laws, regulations and safety requirements or standards, regardless of any support or applications information provided by ON Semiconductor. "Typical" parameters which may be provided in ON Semiconductor data sheets and/or specifications can and do vary in different applications and actual performance may vary over time. All operating parameters, including "Typicals" must be validated for each customer application by customer's technical experts. ON Semiconductor does not convey any license under its patent rights nor the rights of others. ON Semiconductor products are not designed, intended, or authorized for use as a critical component in life support systems or any FDA Class 3 medical devices or medical devices with a same or similar classification in a foreign jurisdiction or any devices intended for implantation in the human body. Should Buyer purchase or use ON Semiconductor products for any such unintended or unauthorized application, Buyer shall indemnify and hold ON Semiconductor and its officers, employees, subsidiaries, affiliates, and distributors harmless against all claims, costs, damages, and expenses, and reasonable attorney fees arising out of, directly or indirectly, any claim of personal injury or death associated with such unintended or unauthorized use, even if such claim alleges that ON Semiconductor was negligent regarding the design or manufacture of the part. ON Semiconductor is an Equal Opportunity/Affirmative Action Employer. This literature is subject to all applicable copyright laws and is not for resale in any manner.



August 2015

# MOC205M, MOC206M, MOC207M, MOC211M, MOC212M, MOC213M, MOC216M, MOC217M 8-pin SOIC Single-Channel Phototransistor Output Optocoupler

## Features

- Closely Matched Current Transfer Ratios
- Minimum  $BV_{CEO}$  of 70 V Guaranteed
  - MOC205M, MOC206M, MOC207M
- Minimum  $BV_{CEO}$  of 30 V Guaranteed
  - MOC211M, MOC212M, MOC213M, MOC216M, MOC217M
- Low LED Input Current Required for Easier Logic Interfacing
  - MOC216M, MOC217M
- Convenient Plastic SOIC-8 Surface Mountable Package Style, with 0.050" Lead Spacing
- Safety and Regulatory Approvals:
  - UL1577, 2,500 VAC<sub>RMS</sub> for 1 Minute
  - DIN-EN/IEC60747-5-5, 565 V Peak Working Insulation Voltage

## Applications

- Feedback Control Circuits
- Interfacing and Coupling Systems of Different Potentials and Impedances
- General Purpose Switching Circuits
- Monitor and Detection Circuits

## Description

These devices consist of a gallium arsenide infrared emitting diode optically coupled to a monolithic silicon phototransistor detector, in a surface mountable, small outline, plastic package. They are ideally suited for high-density applications, and eliminate the need for through-the-board mounting.

## Schematic

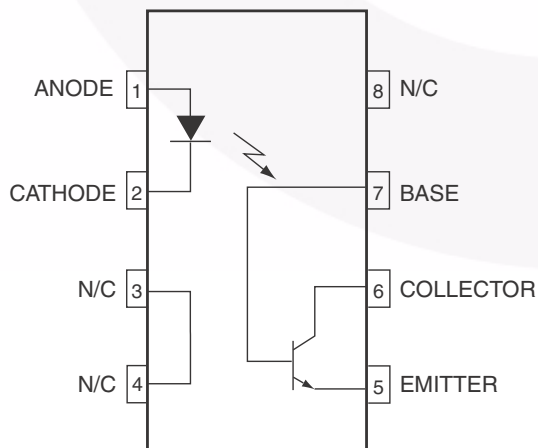

Figure 1. Schematic

## Package Outline

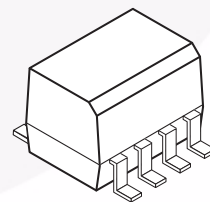

Figure 2. Package Outline

## Safety and Insulation Ratings

As per DIN EN/IEC 60747-5-5, this optocoupler is suitable for “safe electrical insulation” only within the safety limit data. Compliance with the safety ratings shall be ensured by means of protective circuits.

| Parameter   |                        | Characteristics |
|---|------------------------|-----------------|
| Installation Classifications per DIN VDE 0110/1.89 Table 1, For Rated Mains Voltage | < 150 V <sub>RMS</sub> | I–IV            |
|   | < 300 V <sub>RMS</sub> | I–III           |
| Climatic Classification   |                        | 55/100/21       |
| Pollution Degree (DIN VDE 0110/1.89)  |                        | 2               |
| Comparative Tracking Index  |                        | 175             |

| Symbol                | Parameter  | Value             | Unit              |
|-----------------------|--|-------------------|-------------------|
| V <sub>PR</sub>       | Input-to-Output Test Voltage, Method A, V <sub>IORM</sub> × 1.6 = V <sub>PR</sub> , Type and Sample Test with t <sub>m</sub> = 10 s, Partial Discharge < 5 pC  | 904               | V <sub>peak</sub> |
|                       | Input-to-Output Test Voltage, Method B, V <sub>IORM</sub> × 1.875 = V <sub>PR</sub> , 100% Production Test with t <sub>m</sub> = 1 s, Partial Discharge < 5 pC | 1060              | V <sub>peak</sub> |
| V <sub>IORM</sub>     | Maximum Working Insulation Voltage   | 565               | V <sub>peak</sub> |
| V <sub>IOTM</sub>     | Highest Allowable Over-Voltage   | 4000              | V <sub>peak</sub> |
|                       | External Creepage  | ≥ 4               | mm                |
|                       | External Clearance   | ≥ 4               | mm                |
| DTI                   | Distance Through Insulation (Insulation Thickness)   | ≥ 0.4             | mm                |
| T <sub>S</sub>        | Case Temperature <sup>(1)</sup>  | 150               | °C                |
| I <sub>S,INPUT</sub>  | Input Current <sup>(1)</sup>   | 200               | mA                |
| P <sub>S,OUTPUT</sub> | Output Power <sup>(1)</sup>  | 300               | mW                |
| R <sub>IO</sub>       | Insulation Resistance at T <sub>S</sub> , V <sub>IO</sub> = 500 V <sup>(1)</sup>   | > 10 <sup>9</sup> | Ω                 |

### Note:

1. Safety limit values – maximum values allowed in the event of a failure.

## Absolute Maximum Ratings

Stresses exceeding the absolute maximum ratings may damage the device. The device may not function or be operable above the recommended operating conditions and stressing the parts to these levels is not recommended. In addition, extended exposure to stresses above the recommended operating conditions may affect device reliability. The absolute maximum ratings are stress ratings only.  $T_A = 25^\circ\text{C}$  unless otherwise specified.

| Symbol              | Rating  | Value              | Unit                 |
|---------------------|---|--------------------|----------------------|
| <b>TOTAL DEVICE</b> |   |                    |                      |
| $T_{STG}$           | Storage Temperature                                       | -40 to +125        | $^\circ\text{C}$     |
| $T_A$               | Ambient Operating Temperature                             | -40 to +100        | $^\circ\text{C}$     |
| $T_J$               | Junction Temperature                                      | -40 to +125        | $^\circ\text{C}$     |
| $T_{SOL}$           | Lead Solder Temperature                                   | 260 for 10 seconds | $^\circ\text{C}$     |
| $P_D$               | Total Device Power Dissipation @ $T_A = 25^\circ\text{C}$ | 240                | mW                   |
|                     | Derate above $25^\circ\text{C}$                           | 2.94               | mW/ $^\circ\text{C}$ |
| <b>EMITTER</b>      |   |                    |                      |
| $I_F$               | Continuous Forward Current                                | 60                 | mA                   |
| $I_F$ (pk)          | Forward Current – Peak (PW = 100 $\mu\text{s}$ , 120 pps) | 1.0                | A                    |
| $V_R$               | Reverse Voltage   | 6.0                | V                    |
| $P_D$               | LED Power Dissipation @ $T_A = 25^\circ\text{C}$          | 90                 | mW                   |
|                     | Derate above $25^\circ\text{C}$                           | 0.8                | mW/ $^\circ\text{C}$ |
| <b>DETECTOR</b>     |   |                    |                      |
| $I_C$               | Continuous Collector Current                              | 150                | mA                   |
| $V_{CEO}$           | Collector-Emitter Voltage                                 | 30                 | V                    |
| $V_{ECO}$           | Emitter-Collector Voltage                                 | 7                  | V                    |
| $P_D$               | Detector Power Dissipation @ $T_A = 25^\circ\text{C}$     | 150                | mW                   |
|                     | Derate above $25^\circ\text{C}$                           | 1.76               | mW/ $^\circ\text{C}$ |

## Electrical Characteristics

$T_A = 25^\circ\text{C}$  unless otherwise specified.

| Symbol          | Parameter  | Test Conditions   | Min. | Typ.  | Max. | Unit          |
|-----------------|--|---|------|-------|------|---------------|
| <b>EMITTER</b>  |  |   |      |       |      |               |
| $V_F$           | Input Forward Voltage<br>MOC216M, MOC217M  | $I_F = 1\text{ mA}$   |      | 1.07  | 1.3  | V             |
|                 | MOC205M, MOC206M, MOC207M<br>MOC211M, MOC212M, MOC213M   | $I_F = 10\text{ mA}$  |      | 1.15  | 1.5  | V             |
| $I_R$           | Reverse Leakage Current  | $V_R = 6\text{ V}$  |      | 0.001 | 100  | $\mu\text{A}$ |
| $C_{IN}$        | Input Capacitance  |   |      | 18    |      | pF            |
| <b>DETECTOR</b> |  |   |      |       |      |               |
| $I_{CEO1}$      | Collector-Emitter Dark Current   | $V_{CE} = 10\text{ V}, T_A = 25^\circ\text{C}$                                      |      | 1.0   | 50   | nA            |
| $I_{CEO2}$      |  | $V_{CE} = 10\text{ V}, T_A = 100^\circ\text{C}$                                     |      | 1.0   |      | $\mu\text{A}$ |
| $BV_{CEO}$      | Collector-Emitter Breakdown Voltage<br>MOC205M, MOC206M, MOC207M                               | $I_C = 100\text{ }\mu\text{A}$  | 70   | 100   |      | V             |
|                 | MOC211M, MOC212M, MOC213M,<br>MOC216M, MOC217M   | $I_C = 100\text{ }\mu\text{A}$  | 30   | 100   |      | V             |
| $BV_{CBO}$      | Collector-Base Breakdown Voltage   | $I_C = 10\text{ }\mu\text{A}$   | 70   | 120   |      | V             |
| $BV_{ECO}$      | Emitter-Collector Breakdown Voltage  | $I_E = 100\text{ }\mu\text{A}$  | 7    | 10    |      | V             |
| $C_{CE}$        | Collector-Emitter Capacitance  | $f = 1.0\text{ MHz}, V_{CE} = 0$  |      | 7     |      | pF            |
| <b>COUPLED</b>  |  |   |      |       |      |               |
| CTR             | Collector-Output Current<br>MOC205M  | $I_F = 10\text{ mA}, V_{CE} = 10\text{ V}$  | 40   |       | 80   | %             |
|                 | MOC206M  | $I_F = 10\text{ mA}, V_{CE} = 10\text{ V}$  | 63   |       | 125  | %             |
|                 | MOC207M  | $I_F = 10\text{ mA}, V_{CE} = 10\text{ V}$  | 100  |       | 200  | %             |
|                 | MOC211M  | $I_F = 10\text{ mA}, V_{CE} = 10\text{ V}$  | 20   |       |      | %             |
|                 | MOC212M  | $I_F = 10\text{ mA}, V_{CE} = 10\text{ V}$  | 50   |       |      | %             |
|                 | MOC213M  | $I_F = 10\text{ mA}, V_{CE} = 10\text{ V}$  | 100  |       |      | %             |
|                 | MOC216M  | $I_F = 1\text{ mA}, V_{CE} = 5\text{ V}$  | 50   |       |      | %             |
|                 | MOC217M  | $I_F = 1\text{ mA}, V_{CE} = 5\text{ V}$  | 100  |       |      | %             |
| $V_{CE(SAT)}$   | Collector-Emitter Saturation Voltage<br>MOC205M, MOC206M, MOC207M<br>MOC211M, MOC212M, MOC213M | $I_C = 2\text{ mA}, I_F = 10\text{ mA}$   |      |       | 0.4  | V             |
|                 | MOC216M, MOC217M   | $I_C = 100\text{ }\mu\text{A}, I_F = 1\text{ mA}$                                   |      |       | 0.4  | V             |
| $t_{on}$        | Turn-On Time   | $I_C = 2\text{ mA}, V_{CC} = 10\text{ V},$<br>$R_L = 100\text{ }\Omega$ (Figure 12) |      | 7.5   |      | $\mu\text{s}$ |
| $t_{off}$       | Turn-Off Time  | $I_C = 2\text{ mA}, V_{CC} = 10\text{ V},$<br>$R_L = 100\text{ }\Omega$ (Figure 12) |      | 5.7   |      | $\mu\text{s}$ |
| $t_r$           | Rise Time  | $I_C = 2\text{ mA}, V_{CC} = 10\text{ V},$<br>$R_L = 100\text{ }\Omega$ (Figure 12) |      | 3.2   |      | $\mu\text{s}$ |
| $t_f$           | Fall Time  | $I_C = 2\text{ mA}, V_{CC} = 10\text{ V},$<br>$R_L = 100\text{ }\Omega$ (Figure 12) |      | 4.7   |      | $\mu\text{s}$ |

**Isolation Characteristics**

| Symbol    | Characteristic                 | Test Conditions   | Min.      | Typ. | Max. | Unit           |
|-----------|--------------------------------|---|-----------|------|------|----------------|
| $V_{ISO}$ | Input-Output Isolation Voltage | $t = 1 \text{ Minute}$                                  | 2500      |      |      | $V_{AC_{RMS}}$ |
| $C_{ISO}$ | Isolation Capacitance          | $V_{I-O} = 0 \text{ V}, f = 1 \text{ MHz}$              |           | 0.2  |      | pF             |
| $R_{ISO}$ | Isolation Resistance           | $V_{I-O} = \pm 500 \text{ VDC}, T_A = 25^\circ\text{C}$ | $10^{11}$ |      |      | $\Omega$       |



### Typical Performance Curves



**Figure 3. LED Forward Voltage vs. Forward Current**



**Figure 4. Output Current vs. Input Current**

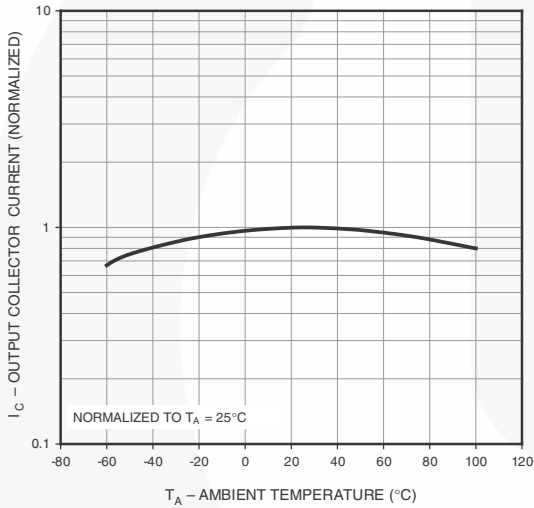

**Figure 5. Output Current vs. Ambient Temperature**



**Figure 6. Output Current vs. Collector-Emitter Voltage**



**Figure 7. Dark Current vs. Ambient Temperature**

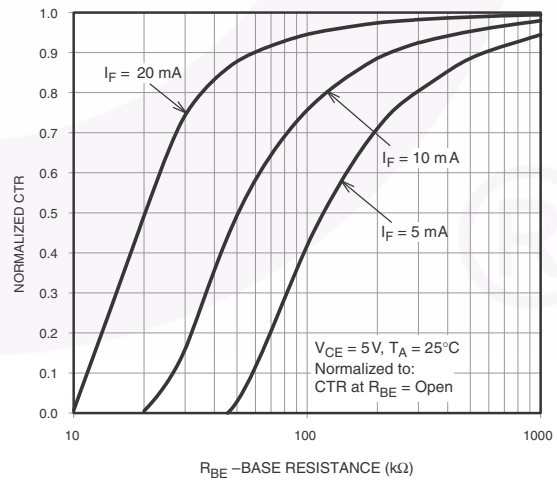

**Figure 8. CTR vs. R<sub>BE</sub> (Unsaturated)**

### Typical Performance Curves (Continued)

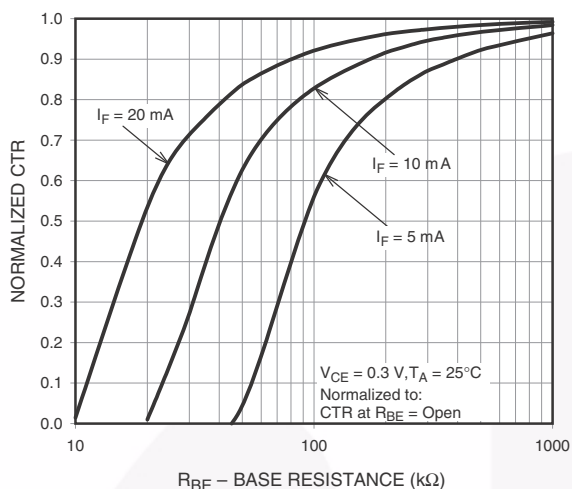

Figure 9. CTR vs.  $R_{BE}$  (Saturated)

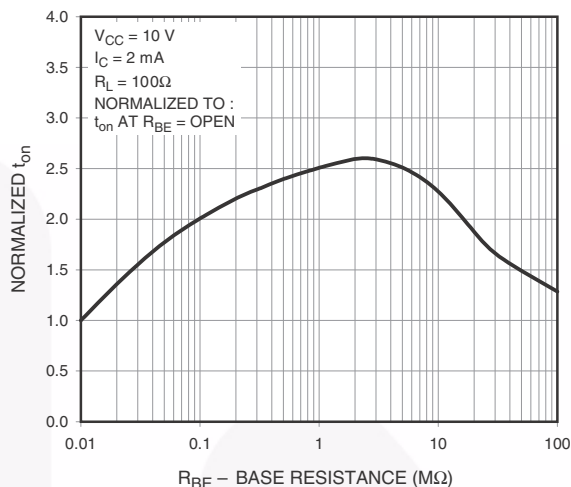

Figure 10. Normalized  $t_{on}$  vs.  $R_{BE}$

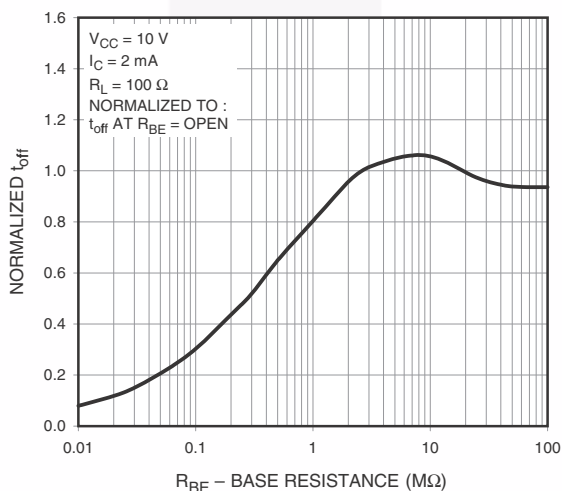

Figure 11. Normalized  $t_{off}$  vs.  $R_{BE}$



Figure 12. Switching Time Test Circuit and Waveforms



## Reflow Profile



Figure 13. Reflow Profile

| Profile Feature                 | Pb-Free Assembly Profile |
|---------------------------------|--------------------------|
| Temperature Minimum (Tsmín)     | 150°C                    |
| Temperature Maximum (Tsmáx)     | 200°C                    |
| Time (ts) from (Tsmín to Tsmáx) | 60–120 seconds           |
| Ramp-up Rate (tL to tp)         | 3°C/second maximum       |
| Liquidous Temperature (TL)      | 217°C                    |
| Time (tL) Maintained Above (TL) | 60–150 seconds           |
| Peak Body Package Temperature   | 260°C +0°C / -5°C        |
| Time (tp) within 5°C of 260°C   | 30 seconds               |
| Ramp-down Rate (TP to TL)       | 6°C/second maximum       |
| Time 25°C to Peak Temperature   | 8 minutes maximum        |

## Ordering Information<sup>(2)</sup>

| Part Number | Package   | Packing Method             |
|-------------|---|----------------------------|
| MOC205M     | Small Outline 8-Pin                             | Tube (100 Units)           |
| MOC205R2M   | Small Outline 8-Pin                             | Tape and Reel (2500 Units) |
| MOC205VM    | Small Outline 8-Pin, DIN EN/IEC60747-5-5 Option | Tube (100 Units)           |
| MOC205R2VM  | Small Outline 8-Pin, DIN EN/IEC60747-5-5 Option | Tape and Reel (2500 Units) |

**Note:**

2. The product orderable part number system listed in this table also applies to the MOC20XM and MOC21XM products.

## Marking Information

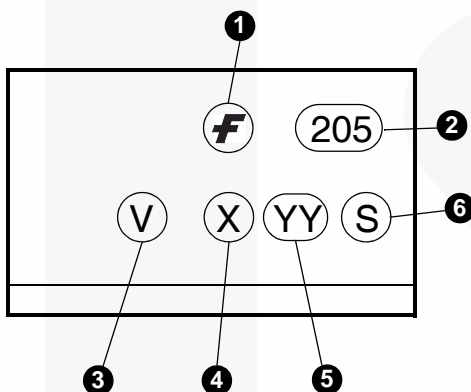

Figure 14. Top Mark

Table 1. Top Mark Definitions

|   |   |
|---|---|
| 1 | Fairchild Logo  |
| 2 | Device Number   |
| 3 | DIN EN/IEC60747-5-5 Option (only appears on component ordered with this option) |
| 4 | One-Digit Year Code, e.g., "4"  |
| 5 | Digit Work Week, Ranging from "01" to "53"                                      |
| 6 | Assembly Package Code   |



NOTES:

- A) NO STANDARD APPLIES TO THIS PACKAGE
- B) ALL DIMENSIONS ARE IN MILLIMETERS.
- C) DIMENSIONS DO NOT INCLUDE MOLD FLASH OR BURRS.
- D) LANDPATTERN STANDARD: SOIC127P600X175-8M.
- E) DRAWING FILENAME: MKT-M08Erev5



ON Semiconductor and  are trademarks of Semiconductor Components Industries, LLC dba ON Semiconductor or its subsidiaries in the United States and/or other countries. ON Semiconductor owns the rights to a number of patents, trademarks, copyrights, trade secrets, and other intellectual property. A listing of ON Semiconductor's product/patent coverage may be accessed at [www.onsemi.com/site/pdf/Patent-Marking.pdf](http://www.onsemi.com/site/pdf/Patent-Marking.pdf). ON Semiconductor reserves the right to make changes without further notice to any products herein. ON Semiconductor makes no warranty, representation or guarantee regarding the suitability of its products for any particular purpose, nor does ON Semiconductor assume any liability arising out of the application or use of any product or circuit, and specifically disclaims any and all liability, including without limitation special, consequential or incidental damages. Buyer is responsible for its products and applications using ON Semiconductor products, including compliance with all laws, regulations and safety requirements or standards, regardless of any support or applications information provided by ON Semiconductor. "Typical" parameters which may be provided in ON Semiconductor data sheets and/or specifications can and do vary in different applications and actual performance may vary over time. All operating parameters, including "Typicals" must be validated for each customer application by customer's technical experts. ON Semiconductor does not convey any license under its patent rights nor the rights of others. ON Semiconductor products are not designed, intended, or authorized for use as a critical component in life support systems or any FDA Class 3 medical devices or medical devices with a same or similar classification in a foreign jurisdiction or any devices intended for implantation in the human body. Should Buyer purchase or use ON Semiconductor products for any such unintended or unauthorized application, Buyer shall indemnify and hold ON Semiconductor and its officers, employees, subsidiaries, affiliates, and distributors harmless against all claims, costs, damages, and expenses, and reasonable attorney fees arising out of, directly or indirectly, any claim of personal injury or death associated with such unintended or unauthorized use, even if such claim alleges that ON Semiconductor was negligent regarding the design or manufacture of the part. ON Semiconductor is an Equal Opportunity/Affirmative Action Employer. This literature is subject to all applicable copyright laws and is not for resale in any manner.

## PUBLICATION ORDERING INFORMATION

### LITERATURE FULFILLMENT:

Literature Distribution Center for ON Semiconductor  
19521 E. 32nd Pkwy, Aurora, Colorado 80011 USA  
**Phone:** 303-675-2175 or 800-344-3860 Toll Free USA/Canada  
**Fax:** 303-675-2176 or 800-344-3867 Toll Free USA/Canada  
**Email:** [orderlit@onsemi.com](mailto:orderlit@onsemi.com)

**N. American Technical Support:** 800-282-9855 Toll Free  
USA/Canada  
**Europe, Middle East and Africa Technical Support:**  
Phone: 421 33 790 2910  
**Japan Customer Focus Center**  
Phone: 81-3-5817-1050

**ON Semiconductor Website:** [www.onsemi.com](http://www.onsemi.com)  
**Order Literature:** <http://www.onsemi.com/orderlit>  
For additional information, please contact your local  
Sales Representative