

EMCL22F2J-100.000M TR

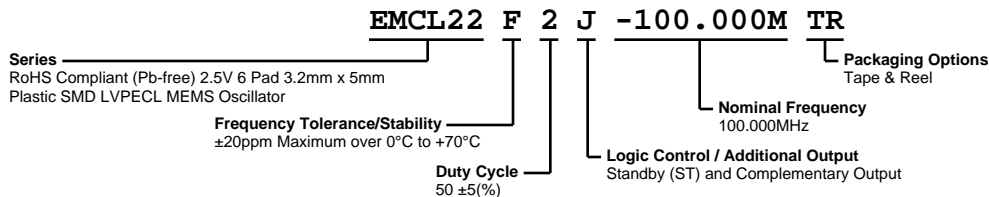

ELECTRICAL SPECIFICATIONS

Nominal Frequency	100.000MHz
Frequency Tolerance/Stability	± 20 ppm Maximum over 0°C to +70°C (Inclusive of all conditions: Calibration Tolerance at 25°C, Frequency Stability over the Operating Temperature Range, Supply Voltage Change, Output Load Change, 1st Year Aging at 25°C, Reflow, Shock, and Vibration)
Aging at 25°C	± 1 ppm First Year Maximum
Supply Voltage	+2.5Vdc ± 0.125 Vdc
Input Current	75mA Maximum (Excluding Load Termination Current)
Output Voltage Logic High (Voh)	1.55Vdc Typical, Vcc-1.025Vdc Minimum
Output Voltage Logic Low (Vol)	0.80Vdc Typical, Vcc-1.62Vdc Maximum
Rise/Fall Time	150pSec Typical, 300pSec Maximum (Measured over 20% to 80% of waveform)
Duty Cycle	50 ± 5 (%) (Measured at 50% of waveform)
Load Drive Capability	50 Ohms into Vcc-2.0Vdc
Output Logic Type	LVPECL
Logic Control / Additional Output	Standby (ST) and Complementary Output
Output Control Input Voltage	Vih of 70% of Vcc Minimum or No Connect to Enable Output and Complementary Output, Vil of 30% of Vcc Maximum to Disable Output and Complementary Output (High Impedance)
Standby Current	30 μ A Maximum (ST) Without Load
Period Jitter (Deterministic)	0.2pSec Typical
Period Jitter (Random)	2.0pSec Typical
Period Jitter (RMS)	1.5pSec Typical, 3.0pSec Maximum
Period Jitter (pk-pk)	20pSec Typical, 25pSec Maximum
RMS Phase Jitter (Fj = 637kHz to 10MHz; Random)	1.7pSec Typical
RMS Phase Jitter (Fj = 1MHz to 20MHz; Random)	1.4pSec Typical
RMS Phase Jitter (Fj = 1.875MHz to 20MHz; Random)	1.1pSec Typical
Start Up Time	10mSec Maximum
Storage Temperature Range	-55°C to +125°C

ENVIRONMENTAL & MECHANICAL SPECIFICATIONS

ESD Susceptibility	MIL-STD-883, Method 3015, Class 2, HBM 2000V
Flammability	UL94-V0
Mechanical Shock	MIL-STD-883, Method 2002, Condition G, 30,000G
Moisture Resistance	MIL-STD-883, Method 1004
Moisture Sensitivity Level	J-STD-020, MSL 1
Resistance to Soldering Heat	MIL-STD-202, Method 210, Condition K
Resistance to Solvents	MIL-STD-202, Method 215
Solderability	MIL-STD-883, Method 2003 (Pads on bottom of package only)
Temperature Cycling	MIL-STD-883, Method 1010, Condition B
Thermal Shock	MIL-STD-883, Method 1011, Condition B
Vibration	MIL-STD-883, Method 2007, Condition A, 20G

EMCL22F2J-100.000M TR

MECHANICAL DIMENSIONS (all dimensions in millimeters)

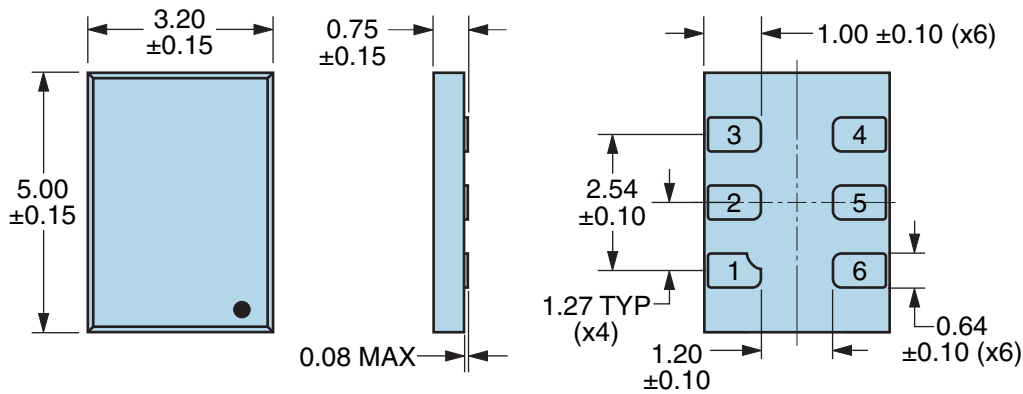

PIN	CONNECTION
1	Standby (ST)
2	No Connect
3	Case Ground
4	Output
5	Complementary Output
6	Supply Voltage

LINE	MARKING
1	XXXXXX XXXXXX=Ecliptek Manufacturing Lot Code

Suggested Solder Pad Layout

All Dimensions in Millimeters

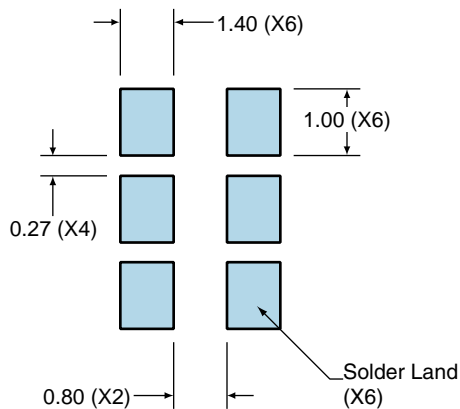

All Tolerances are ± 0.1

EMCL22F2J-100.000M TR

OUTPUT WAVEFORM & TIMING DIAGRAM

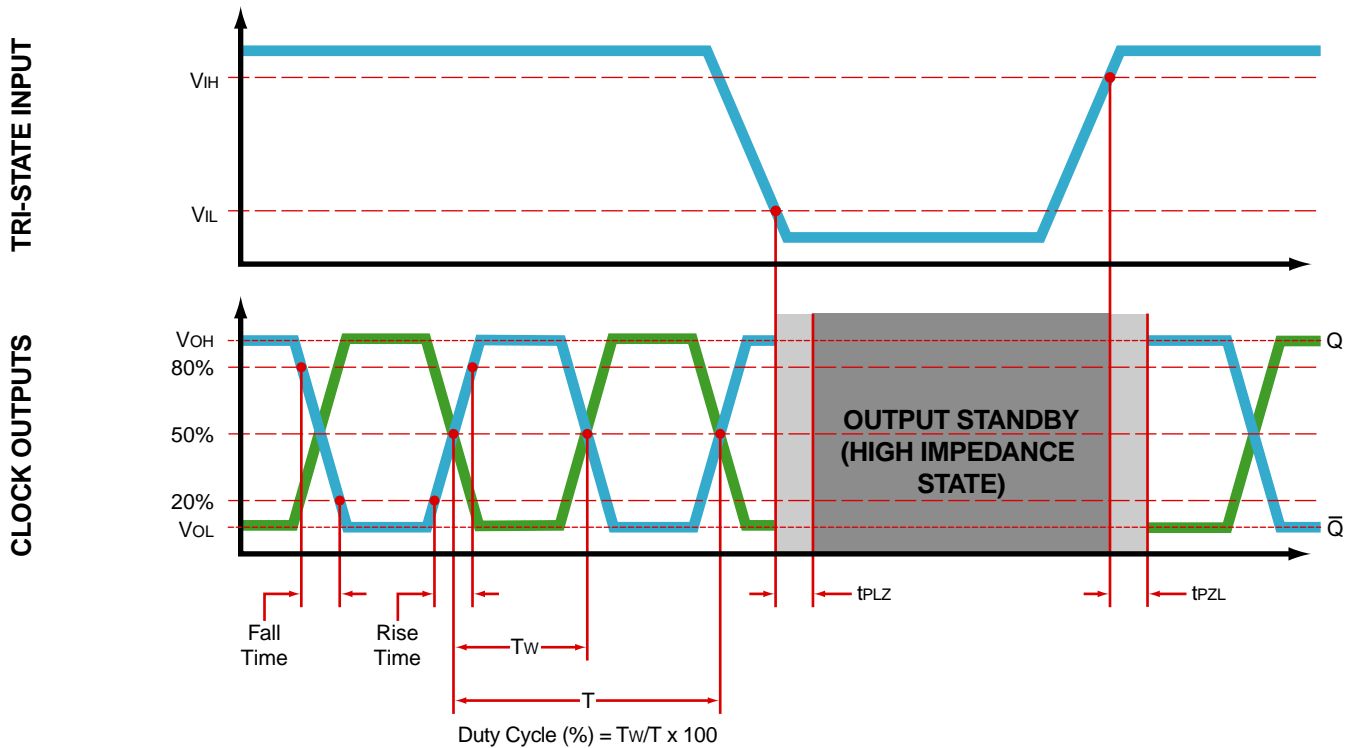

Test Circuit for Tri-State and Complementary Output

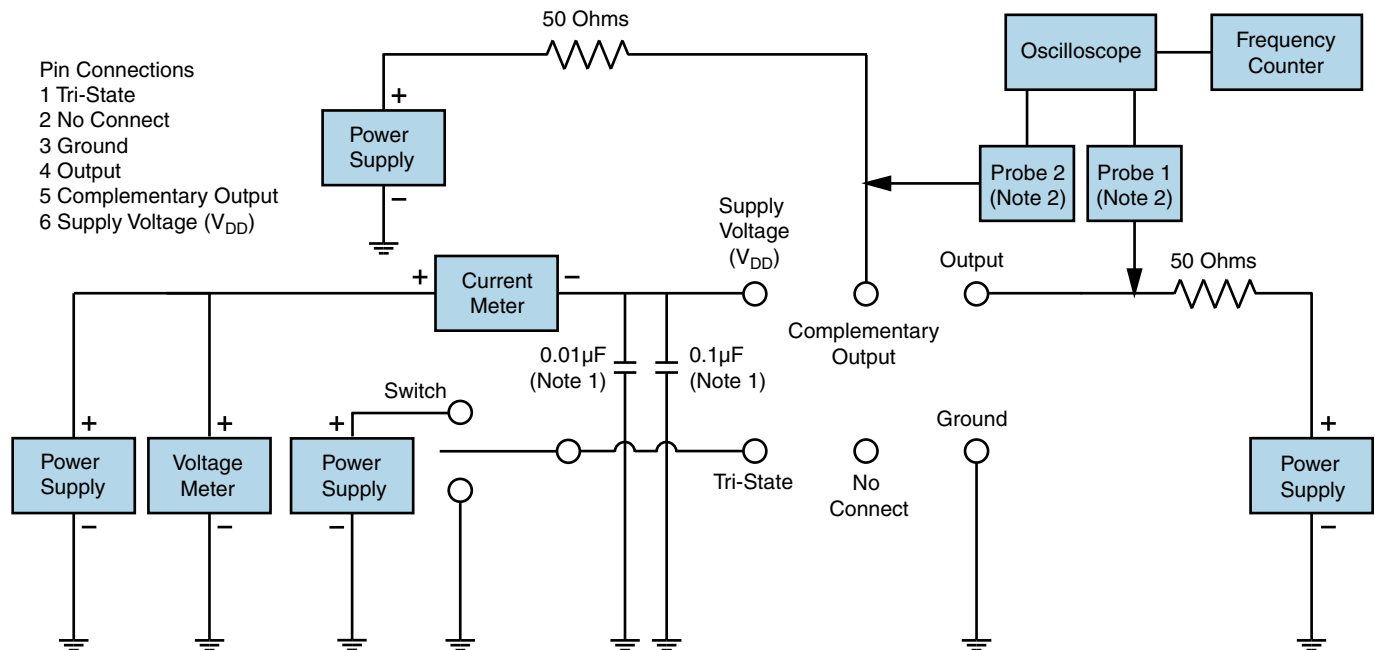

Note 1: An external 0.01µF ceramic bypass capacitor in parallel with a 0.1µF high frequency ceramic bypass capacitor close (less than 2mm) to the package ground and supply voltage pin is required.

Note 2: A low capacitance (<12pF), 10X attenuation factor, high impedance (>10Mohms), and high bandwidth (>500MHz) passive probe is recommended.

Note 3: Test circuit PCB traces need to be designed for a characteristic line impedance of 50 ohms.

EMCL22F2J-100.000M TR

Tape & Reel Dimensions

Quantity Per Reel: 1,000 units

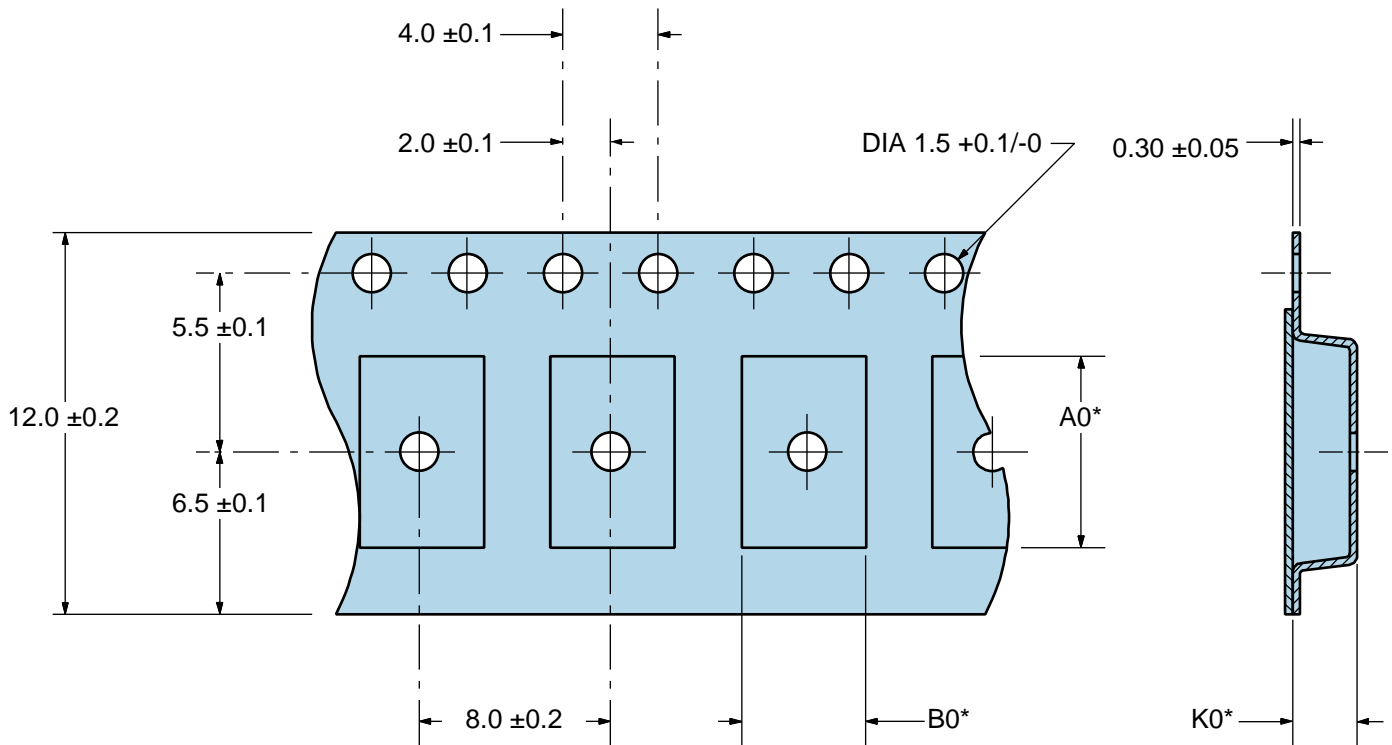

*Compliant to EIA 481A

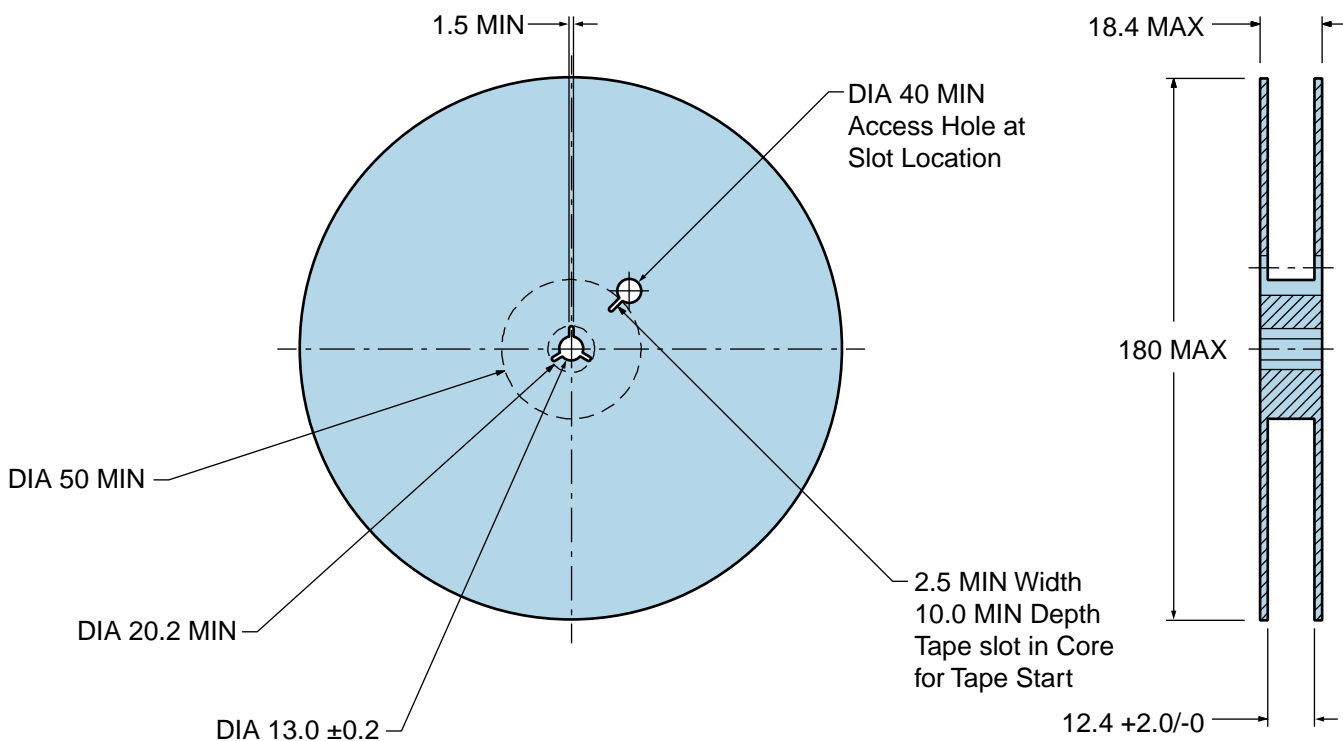

Recommended Solder Reflow Methods



High Temperature Infrared/Convection

T_s MAX to T_L (Ramp-up Rate)	3°C/second Maximum
Preheat	
- Temperature Minimum (T_s MIN)	150°C
- Temperature Typical (T_s TYP)	175°C
- Temperature Maximum (T_s MAX)	200°C
- Time (t_s MIN)	60 - 180 Seconds
Ramp-up Rate (T_L to T_p)	3°C/second Maximum
Time Maintained Above:	
- Temperature (T_L)	217°C
- Time (t_L)	60 - 150 Seconds
Peak Temperature (T_p)	260°C Maximum for 10 Seconds Maximum
Target Peak Temperature (T_p Target)	250°C +0/-5°C
Time within 5°C of actual peak (t_p)	20 - 40 seconds
Ramp-down Rate	6°C/second Maximum
Time 25°C to Peak Temperature (t)	8 minutes Maximum
Moisture Sensitivity Level	Level 1

EMCL22F2J-100.000M TR

Recommended Solder Reflow Methods



Low Temperature Infrared/Convection 240°C

T_s MAX to T_L (Ramp-up Rate)	5°C/second Maximum
Preheat	
- Temperature Minimum (T _s MIN)	N/A
- Temperature Typical (T _s TYP)	150°C
- Temperature Maximum (T _s MAX)	N/A
- Time (t _s MIN)	60 - 120 Seconds
Ramp-up Rate (T_L to T_p)	5°C/second Maximum
Time Maintained Above:	
- Temperature (T _L)	150°C
- Time (t _L)	200 Seconds Maximum
Peak Temperature (T_p)	240°C Maximum
Target Peak Temperature (T_p Target)	240°C Maximum 1 Time / 230°C Maximum 2 Times
Time within 5°C of actual peak (t_p)	10 seconds Maximum 2 Times / 80 seconds Maximum 1 Time
Ramp-down Rate	5°C/second Maximum
Time 25°C to Peak Temperature (t)	N/A
Moisture Sensitivity Level	Level 1

Low Temperature Manual Soldering

185°C Maximum for 10 seconds Maximum, 2 times Maximum.

High Temperature Manual Soldering

260°C Maximum for 5 seconds Maximum, 2 times Maximum.