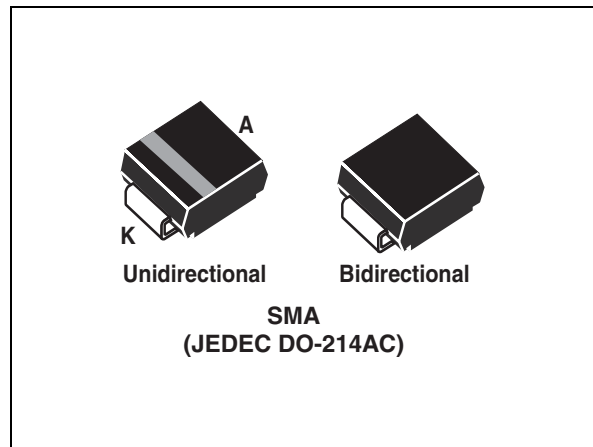


### Features

- Peak pulse power:
  - 400 W (10/1000  $\mu$ s)
  - 2.3 kW (8/20  $\mu$ s)
- Stand off voltage range: from 5 V to 188 V
- Unidirectional and bidirectional types
- Low leakage current:
  - 0.2  $\mu$ A at 25 °C
  - 1  $\mu$ A at 85 °C
- Operating  $T_{j\max}$ : 150 °C
- High power capability at  $T_{j\max}$ :
  - 270 W (10/1000  $\mu$ s)
- JEDEC registered package outline

### Complies with the following standards

- IEC 61000-4-2 level 4
  - 15 kV (air discharge)
  - 8 kV (contact discharge)
- IEC 61000-4-5 (see Table 3 for surge level)
- MIL STD 883G, method 3015-7 Class 3B
  - 25 kV HBM (human body model)
- Resin meets UL 94, V0
- MIL-STD-750, method 2026 solderability
- EIA STD RS-481 and IEC 60286-3 packing
- IPC 7531 footprint



### Description

The SMAJ Transil series has been designed to protect sensitive equipment against electrostatic discharges according to IEC 61000-4-2, and MIL STD 883, method 3015, and electrical over stress according to IEC 61000-4-4 and 5. These devices are generally used against surges below 400 W (10/1000  $\mu$ s).

Planar technology makes these devices suitable for high-end equipment and SMPS where low leakage current and high junction temperature are required to provide reliability and stability over time.

SMAJ are packaged in SMA (SMA footprint in accordance with IPC 7531 standard).

**TM:** Transil is a trademark of STMicroelectronics

# 1 Characteristics

**Table 1. Absolute maximum ratings ( $T_{amb} = 25\text{ }^{\circ}\text{C}$ )**

Symbol	Parameter	Value	Unit
$P_{PP}$	Peak pulse power dissipation <sup>(1)</sup>	$T_j$ initial = $T_{amb}$ 400	W
$T_{stg}$	Storage temperature range	-65 to +150	$^{\circ}\text{C}$
$T_j$	Operating junction temperature range	-55 to +150	$^{\circ}\text{C}$
$T_L$	Maximum lead temperature for soldering during 10 s.	260	$^{\circ}\text{C}$

1. For a surge greater than the maximum values, the diode will fail in short-circuit.

**Table 2. Thermal resistances**

Symbol	Parameter	Value	Unit
$R_{th(j-l)}$	Junction to leads	30	$^{\circ}\text{C}/\text{W}$
$R_{th(j-a)}$	Junction to ambient on printed circuit on recommended pad layout	120	$^{\circ}\text{C}/\text{W}$

**Figure 1. Electrical characteristics - definitions**



**Figure 2. Pulse definition for electrical characteristics**

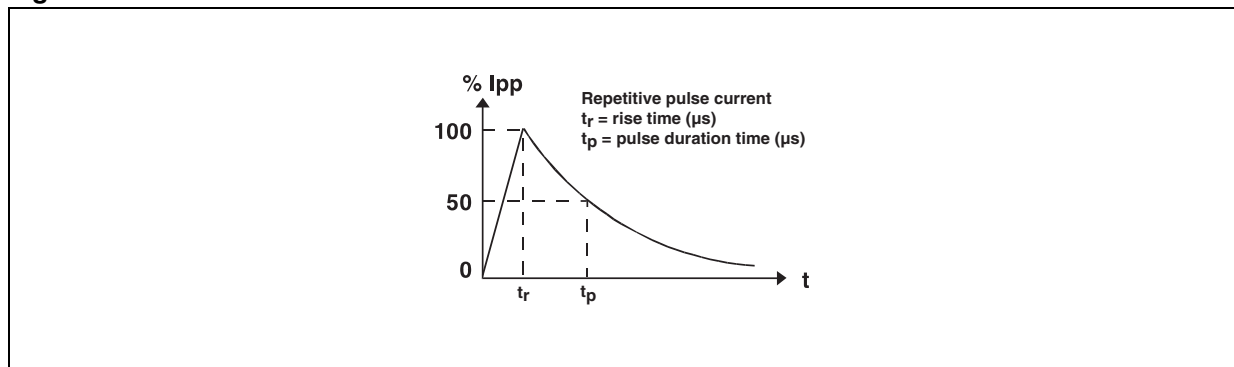


Table 3. Electrical characteristics - parameter values ( $T_{amb} = 25\text{ }^{\circ}\text{C}$ )

Order code	$I_{RM} \text{ max}@V_{RM}$			$V_{BR} @I_R^{(1)}$			$V_{CL} @I_{PP}$ 10/1000 $\mu\text{s}$		$R_D^{(2)}$ 10/1000 $\mu\text{s}$		$V_{CL} @I_{PP}$ 8/20 $\mu\text{s}$		$R_D^{(2)}$ 8/20 $\mu\text{s}$		$\alpha T^{(3)}$
	25 $^{\circ}\text{C}$	85 $^{\circ}\text{C}$		min	typ		max			max			max		
	$\mu\text{A}$		V	V		mA	V	A <sup>(4)</sup>	$\Omega$	V	A <sup>(4)</sup>	$\Omega$		10-4/ $^{\circ}\text{C}$	
SMAJ5.0A/CA	20	50	5	6.4	6.74	10	9.2	43.5	0.049	13.4	174	0.036	5.7		
SMAJ6.0A/CA	20	50	6	6.7	7.05	10	10.3	38.8	0.075	13.7	170	0.037	5.9		
SMAJ6.5A/CA	20	50	6.5	7.2	7.58	10	11.2	35.7	0.091	14.5	160	0.041	6.1		
SMAJ8.5A/CA	20	50	8.5	9.4	9.9	1	14.4	27.7	0.145	19.5	124	0.073	7.3		
SMAJ10A/CA	0.2	1	10	11.1	11.7	1	17	23.5	0.201	21.7	106	0.089	7.8		
SMAJ12A/CA	0.2	1	12	13.3	14	1	19.9	20.1	0.259	25.3	91	0.116	8.3		
SMAJ13A/CA	0.2	1	13	14.4	15.2	1	21.5	18.6	0.298	27.2	85	0.132	8.4		
SMAJ15A/CA	0.2	1	15	16.7	17.6	1	24.4	16.4	0.361	32.5	71	0.197	8.8		
SMAJ18A/CA	0.2	1	18	20	21.1	1	29.2	13.7	0.514	39.3	59	0.291	9.2		
SMAJ20A/CA	0.2	1	20	22.2	23.4	1	32.4	12.3	0.637	42.8	54	0.338	9.4		
SMAJ22A/CA	0.2	1	22	24.4	25.7	1	35.5	11.2	0.760	48.3	48	0.444	9.6		
SMAJ24A/CA	0.2	1	24	26.7	28.1	1	38.9	10.3	0.912	50	46	0.446	9.6		
SMAJ26A/CA	0.2	1	26	28.9	30.4	1	42.1	9.5	1.07	53.5	43	0.502	9.7		
SMAJ28A/CA	0.2	1	28	31.1	32.7	1	45.4	8.8	1.26	59	39	0.632	9.8		
SMAJ30A/CA	0.2	1	30	33.3	35.1	1	48.4	8.3	1.39	64.3	36	0.762	9.9		
SMAJ33A/CA	0.2	1	33	36.7	38.6	1	53.3	7.5	1.70	69.7	33	0.884	10		
SMAJ40A/CA	0.2	1	40	44.4	46.7	1	64.5	6.2	2.49	84	27	1.30	10.1		
SMAJ43A/CA	0.2	1	43	47.8	50.3	1	69.4	5.7	2.91	91	25	1.53	10.2		
SMAJ48A/CA	0.2	1	48	53.3	56.1	1	77.4	5.2	3.56	100	23	1.79	10.3		
SMAJ58A/CA	0.2	1	58	64.4	67.8	1	93.6	4.3	5.21	121	19	2.62	10.4		
SMAJ70A/CA	0.2	1	70	77.8	81.9	1	113	3.5	7.72	146	16	3.75	10.5		
SMAJ85A/CA	0.2	1	85	94	99	1	137	2.9	11.4	178	13	5.70	10.6		
SMAJ100A/CA	0.2	1	100	111	117	1	162	2.5	15.7	212	11	8.10	10.7		
SMAJ130A/CA	0.2	1	130	144	152	1	209	1.9	26.0	265	9	11.7	10.8		
SMAJ154A/CA	0.2	1	154	171	180	1	246	1.6	35.6	317	7	18.3	10.8		
SMAJ170A/CA	0.2	1	170	189	199	1	275	1.4	47.2	353	6.5	22.2	10.8		
SMAJ188A/CA	0.2	1	188	209	220	1	328	1.4	69.3	388	6	26.2	10.8		

1. Pulse test :  $t_p < 50\text{ ms}$

2. To calculate maximum clamping voltage at other surge level, use the following formula:  $V_{CLmax} = V_{CL} - R_D \times (I_{PP} - I_{PPappli})$   
where  $I_{PPappli}$  is the surge current in the application

3. To calculate  $V_{BR}$  or  $V_{CL}$  versus junction temperature, use the following formulas:  
 $V_{BR} @ T_J = V_{BR} @ 25^{\circ}\text{C} \times (1 + \alpha T \times (T_J - 25))$ ,  
 $V_{CL} @ T_J = V_{CL} @ 25^{\circ}\text{C} \times (1 + \alpha T \times (T_J - 25))$

4. Surge capability given for both directions for unidirectional and bidirectional types.

Figure 3. Peak pulse power dissipation versus initial junction temperature

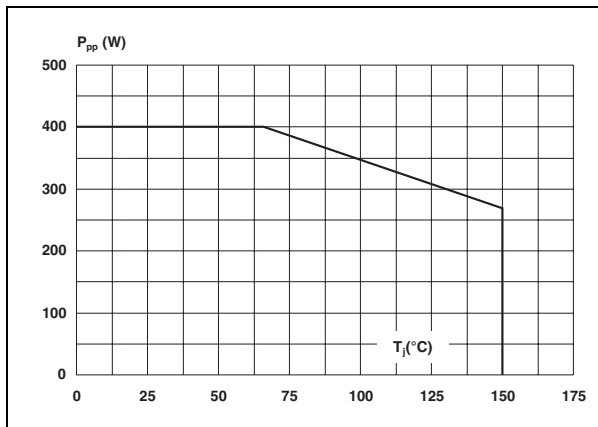


Figure 4. Peak pulse power versus exponential pulse duration (T<sub>j</sub> initial = 25° C)

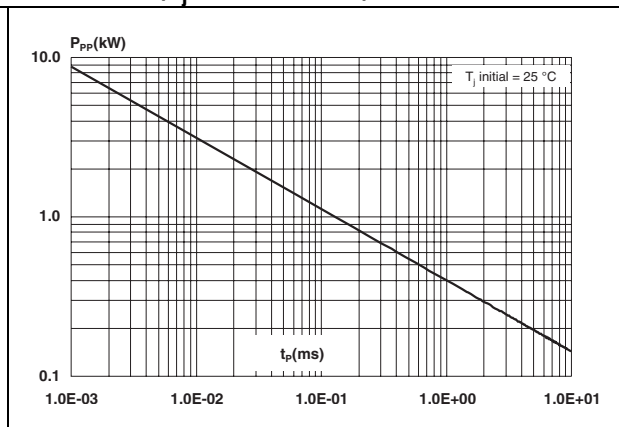
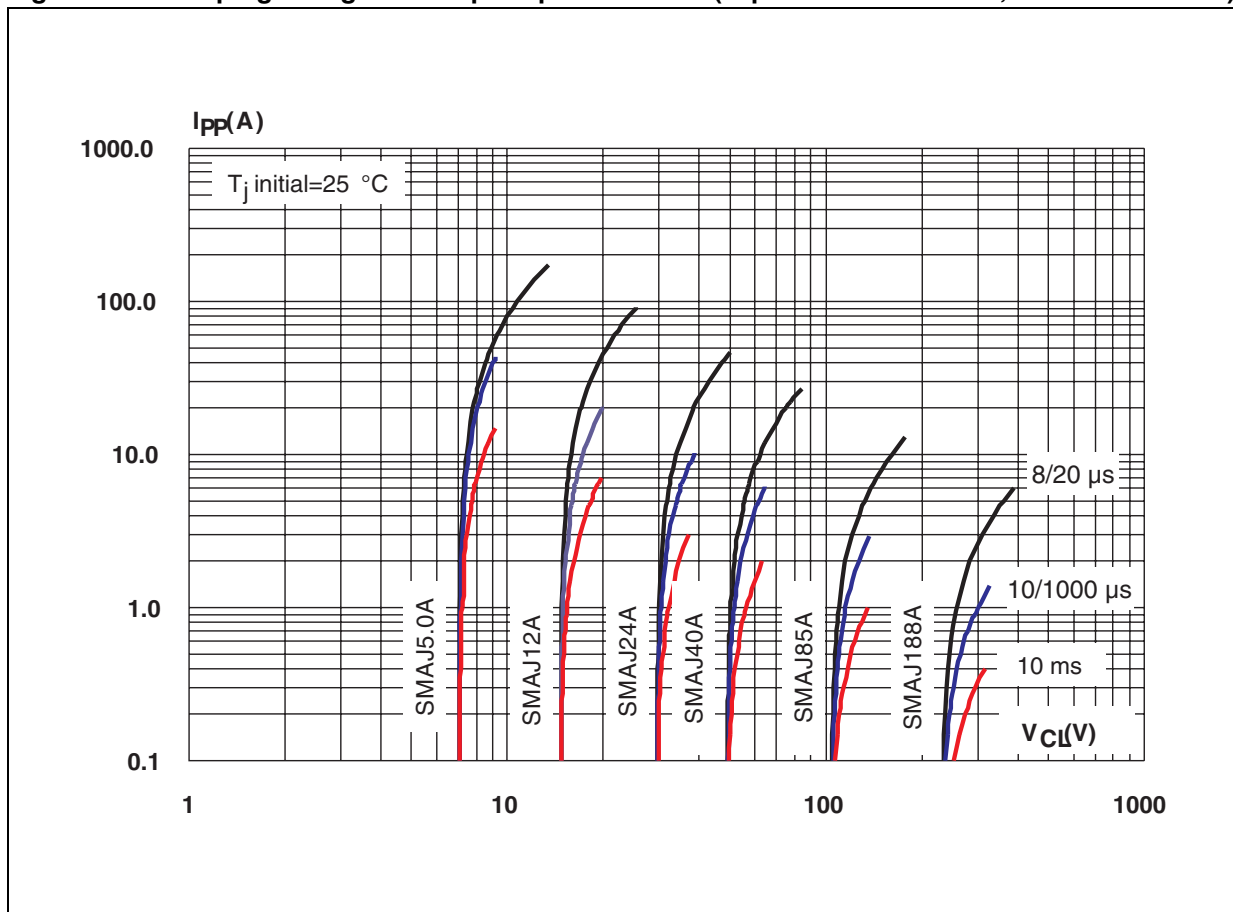
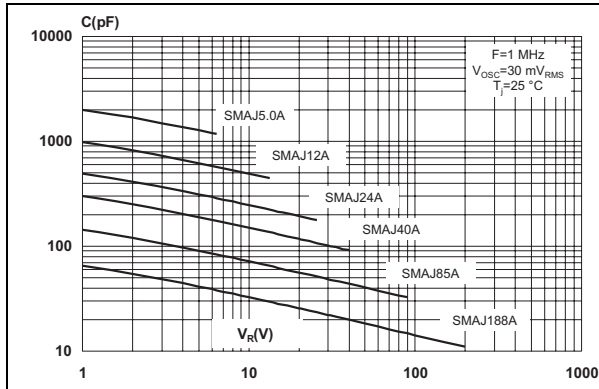


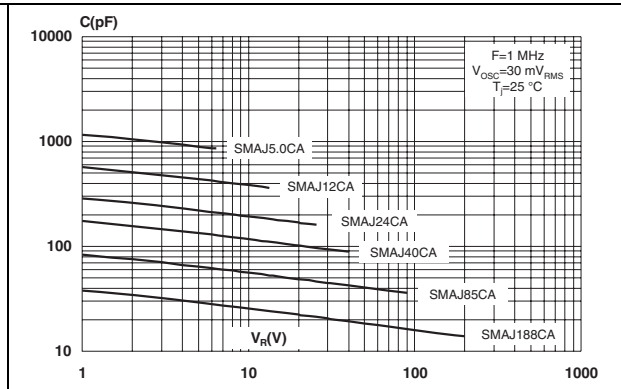
Figure 5. Clamping voltage versus peak pulse current (exponential waveform, maximum values)



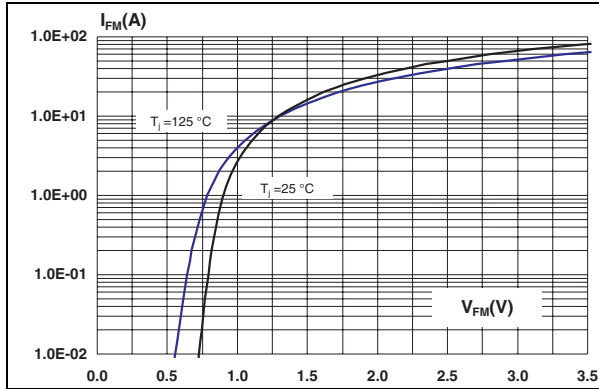
**Figure 6. Junction capacitance versus reverse applied voltage for unidirectional types (typical values)**



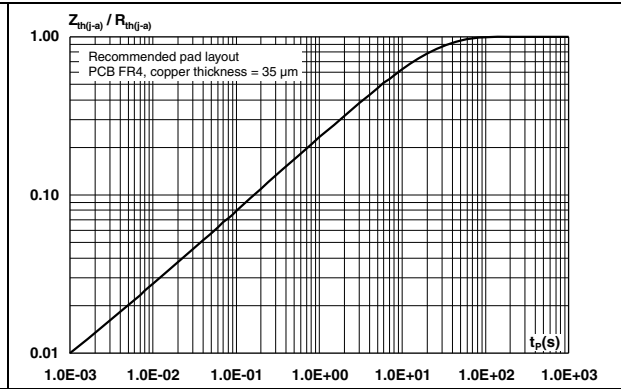
**Figure 7. Junction capacitance versus reverse applied voltage for bidirectional types (typical values)**



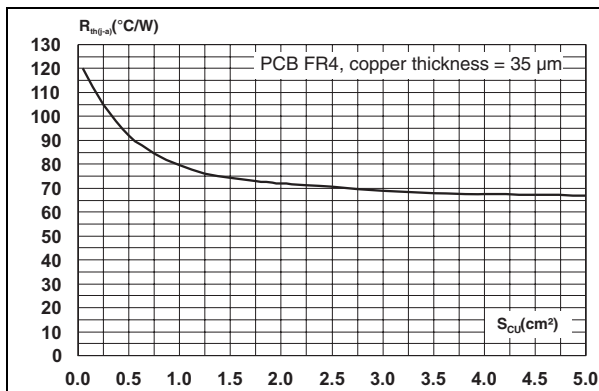
**Figure 8. Peak forward voltage drop versus peak forward current (typical values)**



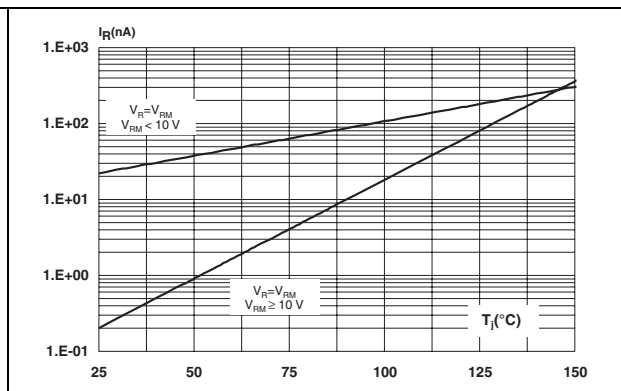
**Figure 9. Relative variation of thermal impedance, junction to ambient, versus pulse duration**



**Figure 10. Thermal resistance, junction to ambient, versus copper surface under each lead**

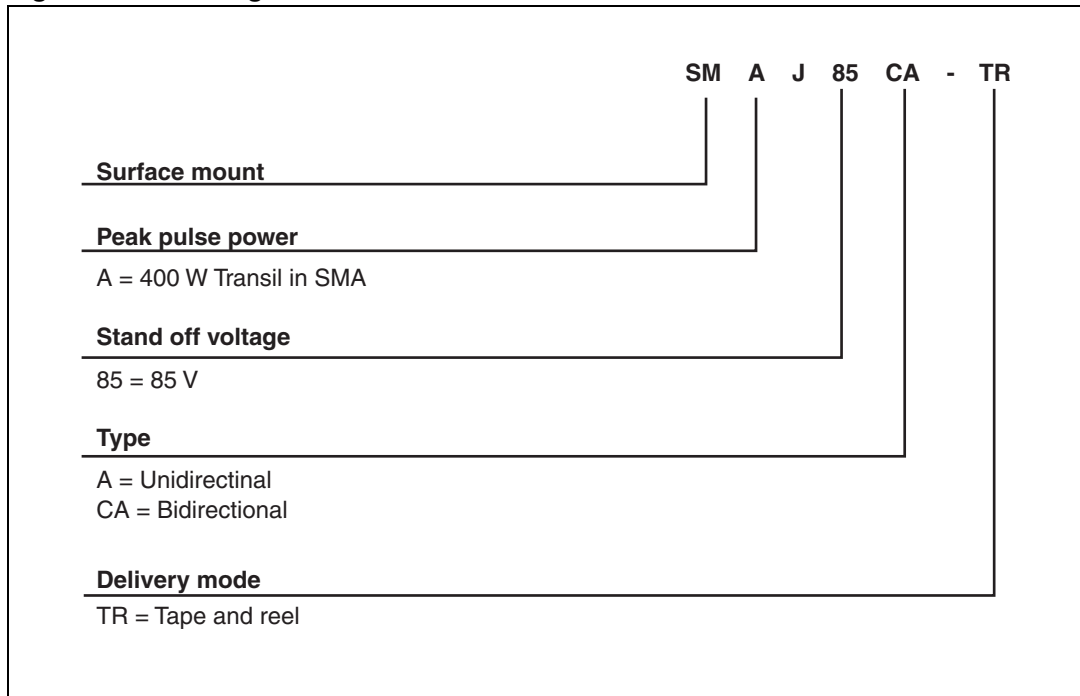


**Figure 11. Leakage current versus junction temperature (typical values)**



## 2 Ordering information scheme

Figure 12. Ordering information scheme



### 3 Package information

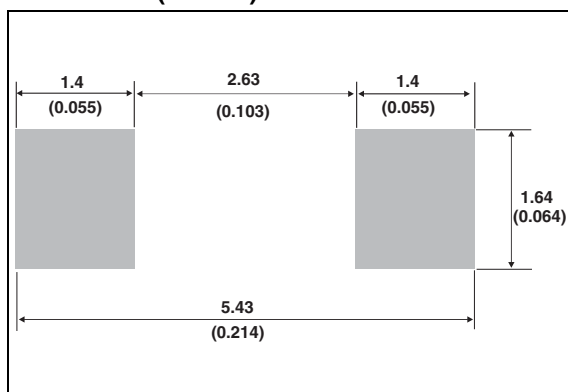
- Case: JEDEC DO-214AC molded plastic over planar junction
- Terminals: solder plated, solderable per MIL-STD-750, Method 2026
- Polarity: for unidirectional types the band indicates cathode.
- Flammability: epoxy is rated UL94V-0
- RoHS package

In order to meet environmental requirements, ST offers these devices in different grades of ECOPACK® packages, depending on their level of environmental compliance. ECOPACK® specifications, grade definitions and product status are available at: [www.st.com](http://www.st.com). ECOPACK® is an ST trademark.

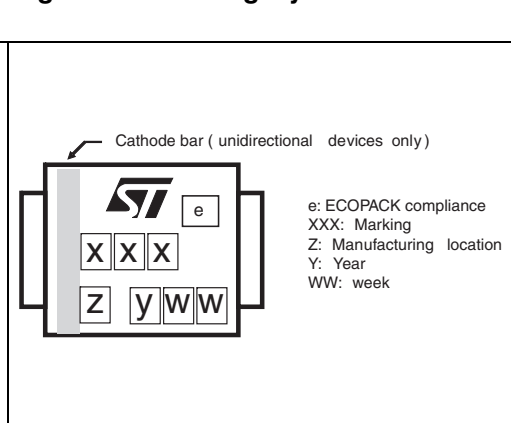
**Table 4. SMA dimensions**

Ref.	Dimensions			
	Millimeters		Inches	
	Min.	Max.	Min.	Max.
A1	1.90	2.45	0.075	0.094
A2	0.05	0.20	0.002	0.008
b	1.25	1.65	0.049	0.065
c	0.15	0.40	0.006	0.016
D	2.25	2.90	0.089	0.114
E	4.80	5.35	0.189	0.211
E1	3.95	4.60	0.156	0.181
L	0.75	1.50	0.030	0.059

**Figure 13. Footprint dimensions in mm (inches)**



**Figure 14. Marking layout<sup>(1)</sup>**



1. Marking layout can vary according to assembly location.

Table 5. Marking

Order code	Marking	Order code	Marking
SMAJ5.0A-TR	AE	SMAJ5.0CA-TR	AA
SMAJ6.0A-TR	DUB	SMAJ6.0CA-TR	DBB
SMAJ6.5A-TR	DUC	SMAJ6.5CA-TR	DBC
SMAJ8.5A-TR	DUH	SMAJ8.5CA-TR	DBH
SMAJ10A-TR	AX	SMAJ10CA-TR	AC
SMAJ12A-TR	DUK	SMAJ12CA-TR	DBK
SMAJ13A-TR	BG	SMAJ13CA-TR	BH
SMAJ15A-TR	BM	SMAJ15CA-TR	AJ
SMAJ18A-TR	DUQ	SMAJ18CA-TR	DBQ
SMAJ20A-TR	DUR	SMAJ20CA-TR	DBR
SMAJ22A-TR	DUS	SMAJ22CA-TR	DBS
SMAJ24A-TR	DUT	SMAJ24CA-TR	DBT
SMAJ26A-TR	DUU	SMAJ26CA-TR	DBU
SMAJ28A-TR	CG	SMAJ28CA-TR	CH
SMAJ30A-TR	CK	SMAJ30CA-TR	CL
SMAJ33A-TR	CM	SMAJ33CA-TR	CN
SMAJ40A-TR	DUZ	SMAJ40CA-TR	DBZ
SMAJ43A-TR	EUA	SMAJ43CA-TR	EBA
SMAJ48A-TR	CX	SMAJ48CA-TR	CY
SMAJ58A-TR	EUF	SMAJ58CA-TR	EBF
SMAJ70A-TR	EUI	SMAJ70CA-TR	EBI
SMAJ85A-TR	EUL	SMAJ85CA-TR	EBL
SMAJ100A-TR	EUN	SMAJ100CA-TR	EBN
SMAJ130A-TR	EUQ	SMAJ130CA-TR	EBQ
SMAJ154A-TR	EUT	SMAJ154CA-TR	EBT
SMAJ170A-TR	SR	SMAJ170CA-TR	SS
SMAJ188A-TR	EUV	SMAJ188CA-TR	EBV



## 4 Ordering information

**Table 6. Ordering information**

Order code	Marking	Package	Weight	Base qty	Delivery mode
SMAJxxxA/CA-TR <sup>(1)</sup>	See <a href="#">Table 5 on page 8</a>	SMA	0.071 g	5000	Tape and reel

1. Where xxx is nominal value of  $V_{BR}$  and A or CA indicates unidirectional or bidirectional version. See [Table 3](#) for list of available devices and their order codes

## 5 Revision history

**Table 7. Document revision history**

Date	Revision	Changes
September-1998	5B	Previous update.
02-Aug-2004	6	SMA package dimensions update. Reference A1 max. changed from 2.70mm (0.106) to 2.03mm (0.080).
10-Dec-2004	7	Template layout update. No content change.
10-Feb-2006	8	Added unidirectional marking on cover page and Figure 14. Changed Figure 13. Foot print.
14-May-2009	9	Updated ECOPACK statement. Reformatted to current standards.
17-Sep-2009	10	Document updated for low leakage current.
05-Nov-2009	11	Corrected typographical error in <a href="#">Package information</a> .
09-Jul-2010	12	Changed timescale in <a href="#">Figure 9</a> .

**Please Read Carefully:**

Information in this document is provided solely in connection with ST products. STMicroelectronics NV and its subsidiaries ("ST") reserve the right to make changes, corrections, modifications or improvements, to this document, and the products and services described herein at any time, without notice.

All ST products are sold pursuant to ST's terms and conditions of sale.

Purchasers are solely responsible for the choice, selection and use of the ST products and services described herein, and ST assumes no liability whatsoever relating to the choice, selection or use of the ST products and services described herein.

No license, express or implied, by estoppel or otherwise, to any intellectual property rights is granted under this document. If any part of this document refers to any third party products or services it shall not be deemed a license grant by ST for the use of such third party products or services, or any intellectual property contained therein or considered as a warranty covering the use in any manner whatsoever of such third party products or services or any intellectual property contained therein.

**UNLESS OTHERWISE SET FORTH IN ST'S TERMS AND CONDITIONS OF SALE ST DISCLAIMS ANY EXPRESS OR IMPLIED WARRANTY WITH RESPECT TO THE USE AND/OR SALE OF ST PRODUCTS INCLUDING WITHOUT LIMITATION IMPLIED WARRANTIES OF MERCHANTABILITY, FITNESS FOR A PARTICULAR PURPOSE (AND THEIR EQUIVALENTS UNDER THE LAWS OF ANY JURISDICTION), OR INFRINGEMENT OF ANY PATENT, COPYRIGHT OR OTHER INTELLECTUAL PROPERTY RIGHT.**

**UNLESS EXPRESSLY APPROVED IN WRITING BY AN AUTHORIZED ST REPRESENTATIVE, ST PRODUCTS ARE NOT RECOMMENDED, AUTHORIZED OR WARRANTED FOR USE IN MILITARY, AIR CRAFT, SPACE, LIFE SAVING, OR LIFE SUSTAINING APPLICATIONS, NOR IN PRODUCTS OR SYSTEMS WHERE FAILURE OR MALFUNCTION MAY RESULT IN PERSONAL INJURY, DEATH, OR SEVERE PROPERTY OR ENVIRONMENTAL DAMAGE. ST PRODUCTS WHICH ARE NOT SPECIFIED AS "AUTOMOTIVE GRADE" MAY ONLY BE USED IN AUTOMOTIVE APPLICATIONS AT USER'S OWN RISK.**

Resale of ST products with provisions different from the statements and/or technical features set forth in this document shall immediately void any warranty granted by ST for the ST product or service described herein and shall not create or extend in any manner whatsoever, any liability of ST.

ST and the ST logo are trademarks or registered trademarks of ST in various countries.

Information in this document supersedes and replaces all information previously supplied.

The ST logo is a registered trademark of STMicroelectronics. All other names are the property of their respective owners.

© 2010 STMicroelectronics - All rights reserved

STMicroelectronics group of companies

Australia - Belgium - Brazil - Canada - China - Czech Republic - Finland - France - Germany - Hong Kong - India - Israel - Italy - Japan - Malaysia - Malta - Morocco - Philippines - Singapore - Spain - Sweden - Switzerland - United Kingdom - United States of America

[www.st.com](http://www.st.com)