[RETURN TO SHORT FORM TABLE OF CONTENTS](#)

[RETURN TO SHORT FORM INDEX](#)

[RETURN TO DIODES INC. NEW PRODUCTS PAGE](#)

Short Form Datasheet Support

Diodes Incorporated
3050 E. Hillcrest Drive
Westlake Village, CA 91362-3154
September 1999

Specifications are subject to change without notice.

The data indicated herein describe the type of component and shall not be considered as assured characteristics.

The products listed in this catalogue are not recommended for use in life support systems where a failure or malfunction of the component may directly threaten life or cause injury.

The user of products in such applications assumes all risks of such use and will agree to hold Diodes Incorporated and all the companies whose products are represented in this catalog, harmless against all damages.

© 1999 Diodes Incorporated.

All Rights Reserved. Printed in the United States.

Specifications subject to change without notice.

Table of Contents

About This Short Form.....	1-1
Part Number Construction	1-2
Technical Support	1-2
Product Ordering / Sampling	1-2
Diodes Incorporated's Vision.....	1-2
Schottky Diodes	2-1
200mW Schottky Diodes / SOT-23.....	2-1
200mW Schottky Diodes / SOD-123	2-1
200mW Schottky Diodes / SOD-323	2-1
200mW Schottky Diodes / SOT-363.....	2-1
200mW Schottky Diodes / SOT-323.....	2-2
400mW Schottky Diodes / mini-MELF	2-3
400mW Schottky Diodes / SOD-123	2-3
400mW Schottky Diodes / DO-35	2-3
Schottky Rectifiers	3-1
0.5A Schottky Rectifiers / SOD-123	3-1
1.0A Schottky Rectifiers / MELF.....	3-1
1.0A Schottky Rectifiers / SMA.....	3-1
1.0A Schottky Rectifiers / SMB.....	3-1
1.0A Schottky Rectifiers / DO-41	3-2
2.0A Schottky Rectifiers / SMA.....	3-2
2.0A Schottky Rectifiers / SMB.....	3-2
3.0A Schottky Rectifiers / SMA.....	3-2
3.0A Schottky Rectifiers / SMB.....	3-2
3.0A Schottky Rectifiers / SMC.....	3-3
3.0A Schottky Rectifiers / DO-201AD	3-3
5.0A Schottky Rectifiers / SMC.....	3-3
5.0A Schottky Rectifiers / DO-201AD	3-3
5.0A Schottky Rectifiers / TO-220AC	3-4
7.5A Schottky Rectifiers / TO-220AC	3-4
8.0A Schottky Rectifiers / DO-201AD	3-4
8.0A Schottky Rectifiers / TO-220AC	3-4
9.0A Schottky Rectifiers / DO-201AD	3-5
10A Schottky Rectifiers / D ² PAK.....	3-5
10A Schottky Rectifiers / TO-220AC	3-5
10A Schottky Rectifiers (DUAL) / TO-220AB	3-5
15A Schottky Rectifiers (DUAL) / D ² PAK	3-6
15A Schottky Rectifiers (DUAL) / TO-220AB	3-6
16A Schottky Rectifiers (DUAL) / D ² PAK	3-6
16A Schottky Rectifiers / TO-220AC	3-6
16A Schottky Rectifiers / TO-220AB	3-6
16A Schottky Rectifiers (DUAL) / TO-3P.....	3-7
20A Schottky Rectifiers (DUAL) / D ² PAK	3-7
20A Schottky Rectifiers (DUAL) / TO-220AB	3-7
20A Schottky Rectifiers (DUAL) / TO-3P.....	3-7
30A Schottky Rectifiers (DUAL) / D ² PAK	3-7
30A Schottky Rectifiers (DUAL) / TO-220AB	3-8

30A Schottky Rectifiers (DUAL) / TO-3P	3-8
40A Schottky Rectifiers (DUAL) / TO-3P	3-8
60A Schottky Rectifiers (DUAL) / TO-3P	3-8
Switching Diodes.....	4-1
200mW Switching Diodes / SOT-323	4-1
350mW Switching Diodes / SOT-23	4-1
200mW Switching Diodes / SOD-323.....	4-2
250mW Switching Diodes / SOD-123.....	4-2
350mW Switching Diodes / SOD-123.....	4-2
500mW Switching Diodes / Micro-MELF	4-2
500mW Switching Diodes / Quadro-MELF.....	4-2
500mW Switching Diodes / Mini-MELF	4-3
500mW Switching Diodes / DO-35.....	4-3
Super-/Ultra Fast Recovery Rectifiers	5-1
1.0A Super-/Ultra-Fast Recovery Glass Passivated Rectifiers / SMA	5-1
1.0A Super-/Ultra-Fast Recovery Rectifiers / DO-41	5-1
1.0A Super-/Ultra-Fast Recovery Glass Passivated Rectifiers / DO-41.....	5-1
1.0A Super-/Ultra-Fast Recovery Glass Passivated Rectifiers / SMB	5-2
1.5A Super-/Ultra-Fast Recovery Rectifiers / DO-15	5-2
1.5A Super-/Ultra-Fast Recovery Rectifiers / DO-41	5-2
2.0A Super-/Ultra-Fast Recovery Glass Passivated Rectifiers / SMA	5-2
2.0A Super-/Ultra-Fast Recovery Glass Passivated Rectifiers / SMB	5-2
2.0A Super-/Ultra-Fast Recovery Rectifiers / DO-15	5-3
2.0A Super-/Ultra-Fast Glass Passivated Recovery Rectifiers / DO-15.....	5-3
3.0A Super-/Ultra-Fast Glass Passivated Recovery Rectifiers / SMB	5-3
3.0A Super-/Ultra-Fast Glass Passivated Recovery Rectifiers / SMC	5-3
3.0A Super-/Ultra-Fast Recovery Glass Passivated Rectifiers / DO-201AD.....	5-4
3.0A Super-/Ultra-Fast Recovery Rectifiers / DO-201AD.....	5-4
16A Super-/Ultra-Fast Recovery Glass Passivated Rectifiers (DUAL) D ² PAK.....	5-4
Fast Recovery Rectifiers	6-1
1.0A Fast Recovery Glass Passivated Rectifiers / MELF	6-1
1.0A Fast Recovery Glass Passivated Rectifiers / SMA	6-1
1.0A Fast Recovery Glass Passivated Rectifiers / SMB.....	6-1
1.0A Fast Recovery Rectifiers / DO-41.....	6-2
1.0A Fast Recovery Glass Passivated Rectifiers / DO-41	6-2
1.0A Fast Recovery Rectifiers / A-405.....	6-2
1.0A Fast Recovery Glass Passivated Rectifiers / A-405.....	6-2
1.5A Fast Recovery Glass Passivated Rectifiers / SMA	6-3
1.5A Fast Recovery Glass Passivated Rectifiers / SMB.....	6-3
1.5A Fast Recovery Rectifiers / DO-15.....	6-3
1.5A Fast Recovery Glass Passivated Rectifiers / DO-15	6-3
1.5A Fast Recovery Rectifiers / DO-41.....	6-4
1.5A Fast Recovery Glass Passivated Rectifiers / DO-41	6-4
2.0A Fast Recovery Rectifiers / DO-15.....	6-4
2.0A Fast Recovery Glass Passivated Rectifiers / DO-15	6-4
3.0A Fast Recovery Glass Passivated Rectifiers / SMB.....	6-4
3.0A Fast Recovery Glass Passivated Rectifiers / SMC.....	6-5
3.0A Fast Recovery Rectifiers / DO-201AD.....	6-5
3.0A Fast Recovery Glass Passivated Rectifiers / DO-201AD	6-5
6.0A Fast Recovery Rectifiers / R-6.....	6-5

Standard Recovery Rectifiers7-1

1.0A Standard Recovery Glass Passivated Rectifiers / MELF..... 7-1
1.0A Standard Recovery Glass Passivated Rectifiers / SMA..... 7-1
1.0A Standard Recovery Glass Passivated Rectifiers / SMB 7-1
1.0A Standard Recovery Glass Passivated Rectifiers / T-1..... 7-1
1.0A Standard Recovery Rectifiers / DO-41 7-2
1.0A Standard Recovery Glass Passivated Rectifiers / DO-41 7-2
1.0A Standard Recovery Rectifiers / A-405..... 7-2
1.0A Standard Recovery Glass Passivated Rectifiers / A-405 7-2
1.5A Standard Recovery Glass Passivated Rectifiers / SMA..... 7-2
1.5A Standard Recovery Glass Passivated Rectifiers / SMB 7-3
1.5A Standard Recovery Rectifiers / DO-15 7-3
1.5A Standard Recovery Glass Passivated Rectifiers / DO-15 7-3
1.5A Standard Recovery Rectifiers / DO-41 7-3
2.0A Standard Recovery Rectifiers / DO-15 7-4
2.0A Standard Recovery Glass Passivated Rectifiers / DO-15 7-4
3.0A Standard Recovery Glass Passivated Rectifiers / SMB 7-4
3.0A Standard Recovery Glass Passivated Rectifiers / SMC 7-4
3.0A Standard Recovery Rectifiers / DO-201AD 7-5
3.0A Standard Recovery Glass Passivated Rectifiers / DO-201AD..... 7-5
5.0A Standard Recovery Glass Passivated Rectifiers / SMC 7-5
6.0A/10A Standard Recovery Rectifiers / R-6 7-5

Bridge Rectifiers.....8-1

0.8A Glass Passivated Bridge Rectifiers / HD MiniDIP 8-1
1.0A Glass Passivated Bridge Rectifiers / DF-S 8-1
1.0A Glass Passivated Bridge Rectifiers / DF-M..... 8-1
1.5A Glass Passivated Bridge Rectifiers / DF-S 8-1
1.5A Glass Passivated Bridge Rectifiers / DF-M..... 8-1
1.5A Glass Passivated Bridge Rectifiers / WOG 8-2
1.5A Glass Passivated Bridge Rectifiers / KBP 8-2
2.0A Glass Passivated Bridge Rectifiers / WOG 8-2
2.0A Glass Passivated Bridge Rectifiers / KBP 8-2
3.0A Bridge Rectifiers / PBPC-3..... 8-3
4.0A Glass Passivated Bridge Rectifiers / KBJ 8-3
4.0A Glass Passivated Bridge Rectifiers / GBU..... 8-3
6.0A Glass Passivated Bridge Rectifiers / KBJ 8-3
6.0A Glass Passivated Bridge Rectifiers / GBJ 8-3
6.0A Glass Passivated Bridge Rectifiers / GBU..... 8-4
6.0A Bridge Rectifiers / PBPC-3..... 8-4
8.0A Glass Passivated Bridge Rectifiers / GBJ 8-4
8.0A Glass Passivated Bridge Rectifiers / GBU..... 8-4
8.0A Bridge Rectifiers / PBPC-8..... 8-4
10A Glass Passivated Bridge Rectifiers / GBJ 8-5
10A Glass Passivated Bridge Rectifiers / GBU..... 8-5
10A Bridge Rectifiers / PBPC-8..... 8-5
15A Glass Passivated Bridge Rectifiers / GBJ 8-5
15A Glass Passivated Bridge Rectifiers / GBPC..... 8-5
15A Glass Passivated Bridge Rectifiers / GBPC-W 8-6
20A Glass Passivated Bridge Rectifiers / GBJ 8-6
25A Glass Passivated Bridge Rectifiers / GBJ 8-6
25A Glass Passivated Bridge Rectifiers / GBPC..... 8-6

25A Glass Passivated Bridge Rectifiers / GBPC-W	8-6
35A Glass Passivated Bridge Rectifiers / GBPC	8-7
35A Glass Passivated Bridge Rectifiers / GBPC-W	8-7
Zener Diodes	9-1
300mW Zener Diodes (DUAL Common Anode) / SOT-23	9-1
350mW Zener Diodes (Single) / SOT-23	9-2
200mW Zener Diodes (DUAL, Isolated) / SOT-363	9-3
200mW Zener Diodes / SOD-323	9-5
200mW Zener Diodes / SOT-323	9-7
300mW Zener Diodes (DUAL Common Cathode) / SOT-23	9-9
410mW Zener Diodes / SOD-123	9-10
500mW Zener Diodes / SOD-123	9-11
350mW Zener Diodes / SOT-23	9-12
500mW Zener Diodes / MicroMELF	9-13
500mW Zener Diodes / QuadroMELF	9-16
500mW Zener Diodes / MiniMELF	9-19
500mW Zener Diodes / DO-35	9-22
1.0W Zener Diodes / SMA	9-25
1.0W Zener Diodes / DO-41	9-26
1.3W Zener Diodes / DO-41	9-27
Transient Voltage Suppressors	10-1
400W Transient Voltage Suppressors / SMA	10-1
500W Transient Voltage Suppressors / DO-15	10-2
600W Transient Voltage Suppressors / SMB	10-3
600W Transient Voltage Suppressors / DO-15	10-4
1500W Transient Voltage Suppressors / SMC	10-6
1500W Transient Voltage Suppressors / DO-201AD	10-7
NPN, PNP Transistors, MOSFET	11-1
NPN Transistors / SOT-323	11-1
Dual NPN Transistors / SOT-363	11-1
NPN Transistors / SOT-23	11-1
PNP Transistors / SOT-323	11-1
PNP Transistors / SOT-23	11-2
Dual PNP Transistors / SOT-363	11-2
Darlington NPN Transistors / SOT-23	11-2
Darlington PNP Transistors / SOT-23	11-2
Complementary NPN/PNP Transistors / SOT-363	11-2
N-Channel MOSFET / SOT-23	11-3
N-Channel MOSFET / SOT-323	11-3
N-Channel MOSFET / SC-59	11-3
N-Channel MOSFET / SOT-363	11-3
Appendix A: Product Packaging Information	A-1
Index	I-1

New Product List

1N4148W	4-2
1N4148WS	4-2
1N4448W	4-2
1N4448WS	4-2
1N5711W	2-1
1N5711WS	2-1
1N6263W	2-3
2N7002	11-3
2N7002DW	11-3
2N7002W	11-3
B0520LW	3-1
B0520W-540W	3-1
B1100LB	3-1
B130LB	3-1
B170-1100	3-1
B170B-1100B	3-1
B270-2100	3-2
B370-3100	3-3
BAS16W	4-1
BAS19W-21W	4-1
BAS31	4-1
BAS40W /04 /05 /06	2-2
BAS70W /04 /05 /06	2-2
BAT42W	2-1
BAT42WS	2-1
BAT43W	2-1
BAT43WS	2-1
BAT46W	2-1
BAT54DW	2-1
BAT54W /AW /CW /SW	2-2
BAT54WS	2-1
BAV16W	4-2
BAV16WS	4-2
BAV19W-21W	4-2
BAV19WS-21WS	4-2
BAV201-203	4-2
BAV23S	4-1
BAV301-303	4-2
BAV70W	4-1
BAV99W	4-1
BAW56W	4-1
BS870	11-3
BZM52(xx)B	9-13
BZM55C(xx)	9-15
BZT52C(xx)	9-10
BZT52C(xx)S	9-5
BZT55C(xx)	9-16
BZX84C(xx)S	9-3
BZX84C(xx)W	9-7

New Product List (continued)

DMN100.....	11-3
GBU10005-1010.....	8-5
GBU4005-410.....	8-3
GBU6005-610.....	8-4
GBU8005-810.....	8-4
HD01-06.....	8-1
LS4148.....	4-2
LS4150.....	4-2
LS4151.....	4-2
LS4154.....	4-2
LS4448.....	4-2
MBR1030CT-10100CT.....	3-5
MBR2070CT-20100CT.....	3-7
MBR2535CT-2560CT.....	3-8
MBR6030PT-6045PT.....	3-8
MCL4148.....	4-2
MCL4151.....	4-2
MCL4154.....	4-2
MCL4448.....	4-2
MMBD4148W.....	4-1
MMBD4448W.....	4-1
MMBD7000.....	4-1
MMBD914.....	4-1
MMBF170.....	11-3
MMBT4124.....	11-1
MMBT4126.....	11-2
MMBT5401.....	11-2
MMBT5551.....	11-1
MMBT6427.....	11-2
MMBTA42.....	11-1
MMBTA55.....	11-2
MMBTA56.....	11-2
MMBTA63.....	11-2
MMBTA64.....	11-2
MMBTA92.....	11-2
MMBZ52(xx)B.....	9-12
MMBZ52(xx)BS.....	9-4
MMBZ52(xx)BW.....	9-8
MMDT2222A.....	11-1
MMDT2227.....	11-2
MMDT2907A.....	11-2
MMDT3904.....	11-1
MMDT3906.....	11-2
MMDT3946.....	11-2
MMDT4401.....	11-1
MMDT4403.....	11-2
MMDT4413.....	11-2
MMST2222A.....	11-1
MMST2907A.....	11-1

New Product List (continued)

MMST3904	11-1
MMST3906	11-1
MMST4401	11-1
MMST4403	11-1
MMSZ52(xx)B	9-11
MMSZ52(xx)BS	9-6
MUR140	5-1
MUR160	5-1
MURS140	5-2
MURS160	5-2
SB170-1100	3-2
SB370-3100	3-3
SB570-5100	3-3
SBG1025L	3-5
SBG1030CT-1045CT	3-5
SBG1630CT-1645CT	3-6
SBG2030CT-2045CT	3-7
SBG3030CT-3060CT	3-7
SBL3030CT-3060CT	3-8
SBL6030PT-6060PT	3-8
SBL870-8100	3-4
SD101AW-CW	2-3
SD101AWS-CWS	2-1
SD103AW-CW	2-3
SD103AWS-CWS	2-1
SD107WS	2-1
SD930-945	3-5
SMAZ(xx)	9-25
TZQ52(xx)B	9-17

About This Short Form

Diodes Incorporated, the customer-oriented manufacturer and supplier of quality discrete semiconductor components, brings you a broad line of devices in a variety of leaded and surface mount packages. These include Schottky Diodes and Rectifiers, Switching Diodes, Super-/Ultra Fast-/Fast-/Standard Recovery Rectifiers, Bridge Rectifiers, Zener Diodes, Transient Voltage Suppressors (TVSs), NPN and PNP Transistors, and MOSFETs.

This *Short Form* gives you easy access to technical information pertaining to our line of discrete semiconductor products. It allows you to locate specific product part numbers and view the associated data at a glance.

NOTE:

- ***Click on any Part Number in the Type Number column to download the datasheet.***

- *To locate information on specific components, refer to the Table of Contents and/or Index.*

Simply click on an entry to jump to your selected topic.

- *The term "New" is used to highlight new products. For an index of these products, refer to the New Product List.*

For each component, the *Short Form* provides:

1. Part numbers
2. Electrical characteristics

To assist you in package selections, Package Outline Dimensions are provided in *Appendix A*.

Part Number Construction

At Diodes Incorporated, dash numbers / letters are appended to the product part numbers (example: ZMM5250B-7), indicating package type and reel size, as shown in the legend below:

A = Ammo Pack
B = Bulk Packaging
T = Tape & Reel
7 = 7-inch Reel
13 = 13-inch Reel
No Suffix = Bridge Rectifiers (Tray or Tube Packaging)

Technical Support

For technical support, contact Diodes Incorporated:

North America

3050 East Hillcrest Drive
Westlake Village, CA 91362-3154
Phone: (805) 446-4800
Fax: (805) 446-4850

Asia

2nd Fl, 501-15 Chung Cheng Road
Hsin Tien, Taipei
Taiwan, R.O.C.
Phone: 886-2-22-180-116
Fax: 886-2-22-180-119 or 22-180-274



Product Ordering / Sampling

To order products listed in this guide, please contact your local Sales Representatives. Since we are continually developing new products to meet your needs, please call your Sales Representatives to check on specific information that you suspect may have changed.

Diodes Incorporated's Vision

“To be the leading supplier and manufacturer of discrete semiconductor products, recognized for our customer service excellence in the electronics industry worldwide.”

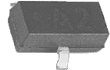
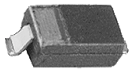
Schottky Diodes

Type Number	Peak Repetitive Reverse Voltage	Forward Continuous Current (†)	Forward Voltage Drop		Maximum Reverse Current (†)		Capacitance (†)	Pin-out Config.
	V_{RRM}	I_{FM}	$V_F @ I_F$		$I_R @ V_R$		C_{TOT}	
	V	mA	V	mA	μA	V	pF (typ)	
200mW Schottky Diodes / SOT-23 								
BAT54	30	200	0.32	1	2.0	25	10	Fig. 1
BAT54A	30	200	0.32	1	2.0	25	10	Fig. 2
BAT54C	30	200	0.32	1	2.0	25	10	Fig. 3
BAT54S	30	200	0.32	1	2.0	25	10	Fig. 4
BAS40	40	200	1.00	40	0.2	30	5	Fig. 1
BAS40-04	40	200	1.00	40	0.2	30	5	Fig. 4
BAS40-05	40	200	1.00	40	0.2	30	5	Fig. 3
BAS40-06	40	200	1.00	40	0.2	30	5	Fig. 2
BAS70	70	200	1.00	15	0.1	50	2	Fig. 1
BAS70-04	70	200	1.00	15	0.1	50	2	Fig. 4
BAS70-05	70	200	1.00	15	0.1	50	2	Fig. 3
BAS70-06	70	200	1.00	15	0.1	50	2	Fig. 2
200mW Schottky Diodes / SOD-123 <i>NEW</i> 								
BAT42W	30	200	0.40	10	0.5	30	10	n/a
BAT43W	30	200	0.33	2	0.5	30	10	n/a
BAT46W	100	150	0.45	10	0.5	1.5	10	n/a
1N5711W	70	15	1.00	15	0.2	50	2.0	n/a
200mW Schottky Diodes / SOD-323 <i>NEW</i> 								
BAT42WS	30	200	0.40	10	0.5	30	10	n/a
BAT43WS	30	200	0.33	2	0.5	30	10	n/a
BAT54WS	30	200	0.32	1	2.0	25	10	n/a
SD101AWS	60	15	1.00	15	0.2	50	2.0	n/a
SD101BWS	50	15	0.95	15	0.2	40	2.1	n/a
SD101CWS	40	15	0.90	15	0.2	30	2.2	n/a
SD103AWS	40	350	0.60	200	5.0	30	50	n/a
SD103BWS	30	350	0.60	200	5.0	20	50	n/a
SD103CWS	20	350	0.60	200	5.0	10	50	n/a
SD107WS	30	100	0.80	100	1.0	25	7	n/a
1N5711WS	70	15	1.00	15	0.2	50	2.0	n/a
200mW Schottky Diodes / SOT-363 <i>NEW</i> 								
BAT54DW	30	200	0.32	1	2.0	25	10	n/a

(†) Reference product datasheet for specific test conditions.

Type Number	Peak Repetitive Reverse Voltage	Forward Continuous Current (†)	Forward Voltage Drop		Maximum Reverse Current (†)		Capacitance (†)	Pin-out Config.
	V_{RRM}	I_{FM}	$V_F @ I_F$		$I_R @ V_R$		C_{TOT}	
	V	mA	V	mA	μA	V	pF (typ)	

200mW Schottky Diodes / SOT-323 NEW



BAT54W	30	200	0.32	1.0	2.0	25	10	Fig.1
BAT54AW	30	200	0.32	1.0	2.0	25	10	Fig.2
BAT54CW	30	200	0.32	1.0	2.0	25	10	Fig.3
BAT54SW	30	200	0.32	1.0	2.0	25	10	Fig.4
BAS40W	40	200	1.00	40	0.2	30	5.0	Fig. 1
BAS40W-04	40	200	1.00	40	0.2	30	5.0	Fig. 4
BAS40W-05	40	200	1.00	40	0.2	30	5.0	Fig. 3
BAS40W-06	40	200	1.00	40	0.2	30	5.0	Fig. 2
BAS70W	70	200	1.00	15	0.1	50	2.0	Fig. 1
BAS70W-04	70	200	1.00	15	0.1	50	2.0	Fig. 4
BAS70W-05	70	200	1.00	15	0.1	50	2.0	Fig. 3
BAS70W-06	70	200	1.00	15	0.1	50	2.0	Fig. 2

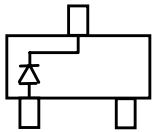

Figure 1, Single

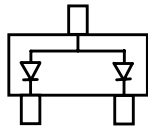

Figure 2, Common Anode

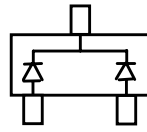

Figure 3, Common Cathode

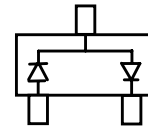

Figure 4, Series

(†) Reference product datasheet for specific test conditions.

Type Number	Peak Repetitive Reverse Voltage	Forward Continuous Current (†)	Forward Voltage Drop		Maximum Reverse Current (†)		Capacitance (†)
	V_{RRM}	I_{FM}	$V_F @ I_F$		$I_R @ V_R$		C_{TOT}
	V	mA	V	mA	μA	V	pF (typ)

400mW Schottky Diodes / mini-MELF



LLSD101A	60	15	1.00	15	0.20	50	2.0
LLSD101B	50	15	0.95	15	0.20	40	2.1
LLSD101C	40	15	0.90	15	0.20	30	2.2
LL5711**	70	15	1.00	15	0.20	50	2.0
LL6263	60	15	1.00	15	0.20	50	2.0
LL46*	100	150	0.45	10	5.0	75	6.0
LL42*	30	200	0.40	10	0.50	25	10
LL43*	30	200	0.33	2	0.50	25	10
LLSD103A	40	350	0.60	200	5.0	30	50
LLSD103B	30	350	0.60	200	5.0	20	50
LLSD103C	20	350	0.60	200	5.0	10	50

* Power dissipation (Pd)=200mW

**Power dissipation (Pd)=250mW

400mW Schottky Diodes / SOD-123 **NEW**

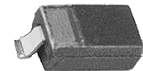

SD101AW	60	15	1.00	15	0.20	50	2.0
SD101BW	50	15	0.95	15	0.20	40	2.1
SD101CW	40	15	0.90	15	0.20	30	2.2
SD103AW	40	350	0.60	200	5.0	30	50
SD103BW	30	350	0.60	200	5.0	20	50
SD103CW	20	350	0.60	200	5.0	10	50
1N6263W	60	50	1.00	15	0.2	50	2.0

400mW Schottky Diodes / DO-35





SD101A	60	15	1.00	15	0.20	50	2.0
SD101B	50	15	0.95	15	0.20	40	2.1
SD101C	40	15	0.90	15	0.20	30	2.2
1N5711**	70	15	1.00	15	0.20	50	2.0
1N6263	60	15	1.00	15	0.20	50	2.0
BAT46*	100	150	0.45	10	5.0	75	6.0
BAT42*	30	200	0.40	10	0.50	25	10
BAT43*	30	200	0.33	2	0.50	25	10
SD103A	40	350	0.60	200	5.0	30	50
SD103B	30	350	0.60	200	5.0	20	50
SD103C	20	350	0.60	200	5.0	10	50

* Power dissipation (Pd)=200mW



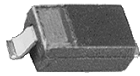

** Power dissipation (Pd)=250mW

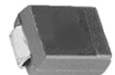
(†) Reference product datasheet for specific test conditions.

Schottky Rectifiers

Type Number	Peak Repetitive Reverse Voltage	Maximum Average Rectified Current (†)		Maximum Peak Forward Surge Current (†)	Forward Voltage Drop		Maximum Reverse Current (†)	
	V_{RRM}	$I_O @ T_T$		I_{FSM}	$V_F @ I_F$		$I_R @ V_R$	
	V	A	°C	A	V	A	mA	V
0.5A Schottky Rectifiers / SOD-123  NEW								
B0520LW	20	.5	100	5.5	.385	0.5	.075	10
B0520W	20	.5	95	5.5	.385	0.5	.075	10
B0530W	30	.5	100	5.5	.430	0.5	.02	15
B0540W	40	.5	100	5.5	.510	0.5	.01	20
1.0A Schottky Rectifiers / MELF 								
1N5817M	20	1.0	90	25	0.45	1.0	1.0	20
1N5818M	30	1.0	90	25	0.55	1.0	1.0	30
1N5819M	40	1.0	90	25	0.60	1.0	1.0	40
1.0A Schottky Rectifiers / SMA 								
B120	20	1.0	130	30	0.50	1.0	0.5	20
B130	30	1.0	130	30	0.50	1.0	0.5	30
B140	40	1.0	130	30	0.50	1.0	0.5	40
B150	50	1.0	130	30	0.70	1.0	0.5	50
B160	60	1.0	130	30	0.70	1.0	0.5	60
B170 NEW	70	1.0	125	30	0.79	1.0	0.5	70
B180 NEW	80	1.0	125	30	0.79	1.0	0.5	80
B190 NEW	90	1.0	125	30	0.79	1.0	0.5	90
B1100 NEW	100	1.0	125	30	0.79	1.0	0.5	100
1.0A Schottky Rectifiers / SMB 								
B120B	20	1.0	130	30	0.50	1.0	0.5	20
B130B	30	1.0	130	30	0.50	1.0	0.5	30
B140B	40	1.0	130	30	0.50	1.0	0.5	40
B150B	50	1.0	130	30	0.70	1.0	0.5	50
B160B	60	1.0	130	30	0.70	1.0	0.5	60
B170B NEW	70	1.0	125	30	0.79	1.0	0.5	70
B180B NEW	80	1.0	125	30	0.79	1.0	0.5	80
B190B NEW	90	1.0	125	30	0.79	1.0	0.5	90
B1100B NEW	100	1.0	125	30	0.79	1.0	0.5	100
B130LB NEW	30	1.0	120	40	0.395	1.0	1.0	30
B1100LB NEW	100	1.0	120	50	0.75	1.0	0.5	100

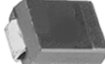
(†) Reference product datasheet for specific test conditions.

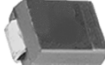
Type Number	Peak Repetitive Reverse Voltage	Maximum Average Rectified Current (†)		Maximum Peak Forward Surge Current (†)	Forward Voltage Drop		Maximum Reverse Current (†)		
	V_{RRM}	$I_O @ T_T$		I_{FSM}	$V_F @ I_F$		$I_R @ V_R$		
	V	A	°C	A	V	A	mA	V	
1.0A Schottky Rectifiers / DO-41 									
1N5817	20	1.0	90	25	0.45	1.0	1.0	20	
1N5818	30	1.0	90	25	0.55	1.0	1.0	30	
1N5819	40	1.0	90	25	0.60	1.0	1.0	40	
SB120	20	1.0	80	40	0.50	1.0	0.5	20	
SB130	30	1.0	80	40	0.50	1.0	0.5	30	
SB140	40	1.0	80	40	0.50	1.0	0.5	40	
SB150	50	1.0	80	40	0.70	1.0	0.5	50	
SB160	60	1.0	80	40	0.70	1.0	0.5	60	
SB170 ^{NEW}	70	1.0	80	40	0.80	1.0	0.5	70	
SB180 ^{NEW}	80	1.0	80	40	0.80	1.0	0.5	80	
SB190 ^{NEW}	90	1.0	80	40	0.80	1.0	0.5	90	
SB1100 ^{NEW}	100	1.0	80	40	0.80	1.0	0.5	100	
2.0A Schottky Rectifiers / SMA 									
B220A	20	2.0	100	50	0.50	2.0	0.5	20	
B230A	30	2.0	100	50	0.50	2.0	0.5	30	
B240A	40	2.0	100	50	0.50	2.0	0.5	40	
B250A	50	2.0	100	50	0.70	2.0	0.5	50	
B260A	60	2.0	100	50	0.70	2.0	0.5	60	
2.0A Schottky Rectifiers / SMB 									
B220	20	2.0	100	50	0.50	2.0	0.5	20	
B230	30	2.0	100	50	0.50	2.0	0.5	30	
B240	40	2.0	100	50	0.50	2.0	0.5	40	
B250	50	2.0	100	50	0.70	2.0	0.5	50	
B260	60	2.0	100	50	0.70	2.0	0.5	60	
B270 ^{NEW}	70	2.0	125	50	0.79	2.0	0.5	70	
B280 ^{NEW}	80	2.0	125	50	0.79	2.0	0.5	80	
B290 ^{NEW}	90	2.0	125	50	0.79	2.0	0.5	90	
B2100 ^{NEW}	100	2.0	125	50	0.79	2.0	0.5	100	
3.0A Schottky Rectifiers / SMA 									
B320A	20	3.0	110	100	0.50	3.0	0.5	20	
B330A	30	3.0	110	100	0.50	3.0	0.5	30	
B340A	40	3.0	110	100	0.50	3.0	0.5	40	
B350A	50	3.0	110	100	0.70	3.0	0.5	50	
B360A	60	3.0	110	100	0.70	3.0	0.5	60	
3.0A Schottky Rectifiers / SMB 									
B320B	20	3.0	110	100	0.50	3.0	0.5	20	
B330B	30	3.0	110	100	0.50	3.0	0.5	30	
B340B	40	3.0	110	100	0.50	3.0	0.5	40	
B350B	50	3.0	110	100	0.70	3.0	0.5	50	
B360B	60	3.0	110	100	0.70	3.0	0.5	60	

(†) Reference product datasheet for specific test conditions.

Type Number	Peak Repetitive Reverse Voltage	Maximum Average Rectified Current (†)		Maximum Peak Forward Surge Current (†)	Forward Voltage Drop		Maximum Reverse Current (†)	
	V_{RRM}	$I_O @ T_T$		I_{FSM}	$V_F @ I_F$		$I_R @ V_R$	
	V	A	°C	A	V	A	mA	V

3.0A Schottky Rectifiers / SMC



B320	20	3.0	110	100	0.50	3.0	0.5	20
B330	30	3.0	110	100	0.50	3.0	0.5	30
B340	40	3.0	110	100	0.50	3.0	0.5	40
B350	50	3.0	110	100	0.70	3.0	0.5	50
B360	60	3.0	110	100	0.70	3.0	0.5	60
B370 ^{NEW}	70	3.0	125	100	0.79	3.0	0.5	70
B380 ^{NEW}	80	3.0	125	100	0.79	3.0	0.5	80
B390 ^{NEW}	90	3.0	125	100	0.79	3.0	0.5	90
B3100 ^{NEW}	100	3.0	125	100	0.79	3.0	0.5	100

3.0A Schottky Rectifiers / DO-201AD



1N5820	20	3.0	90*	80	0.475	3.0	2.0	20
1N5821	30	3.0	90*	80	0.500	3.0	2.0	30
1N5822	40	3.0	90*	80	0.525	3.0	2.0	40
SB320	20	3.0	80*	80	0.50	3.0	0.5	20
SB330	30	3.0	80*	80	0.50	3.0	0.5	30
SB340	40	3.0	80*	80	0.50	3.0	0.5	40
SB350	50	3.0	80*	80	0.74	3.0	0.5	50
SB360	60	3.0	80*	80	0.74	3.0	0.5	60
SB370 ^{NEW}	70	3.0	80*	80	0.80	3.0	0.5	70
SB380 ^{NEW}	80	3.0	80*	80	0.80	3.0	0.5	80
SB390 ^{NEW}	90	3.0	80*	80	0.80	3.0	0.5	90
SB3100 ^{NEW}	100	3.0	80*	80	0.80	3.0	0.5	100

* TL, Lead Temperature at a distance of 9.5mm from case.

5.0A Schottky Rectifiers / SMC



B520C	20	5.0	110	175	0.55	5.0	0.5	20
B530C	30	5.0	110	175	0.55	5.0	0.5	30
B540C	40	5.0	110	175	0.55	5.0	0.5	40
B550C	50	5.0	110	175	0.70	5.0	0.5	50
B560C	60	5.0	110	175	0.70	5.0	0.5	60

5.0A Schottky Rectifiers / DO-201AD



SB520	20	5.0	80	150	0.55	5.0	0.5	20
SB530	30	5.0	80	150	0.55	5.0	0.5	30
SB540	40	5.0	80	150	0.55	5.0	0.5	40
SB550	50	5.0	80	150	0.70	5.0	0.5	50
SB560	60	5.0	80	150	0.70	5.0	0.5	60
SB570 ^{NEW}	70	5.0	80	150	0.80	5.0	0.5	70
SB580 ^{NEW}	80	5.0	80	150	0.80	5.0	0.5	80
SB590 ^{NEW}	90	5.0	80	150	0.80	5.0	0.5	90
SB5100 ^{NEW}	100	5.0	80	150	0.80	5.0	0.5	100

(†) Reference product datasheet for specific test conditions.

Type Number	Peak Repetitive Reverse Voltage	Maximum Average Rectified Current (†)		Maximum Peak Forward Surge Current (†)	Forward Voltage Drop		Maximum Reverse Current (†)	
	V_{RRM}	$I_O @ T_T$		I_{FSM}	$V_F @ I_F$		$I_R @ V_R$	
	V	A	°C	A	V	A	mA	V

5.0A Schottky Rectifiers / TO-220AC



SBL530	30	5.0	95	175	0.55	5.0	0.5	30
SBL535	35	5.0	95	175	0.55	5.0	0.5	35
SBL540	40	5.0	95	175	0.55	5.0	0.5	40
SBL545	45	5.0	95	175	0.55	5.0	0.5	45
SBL550	50	5.0	95	175	0.70	5.0	0.5	50
SBL560	60	5.0	95	175	0.70	5.0	0.5	60

7.5A Schottky Rectifiers / TO-220AC



MBR730	30	7.5	125	150	0.55	7.5	1.0	30
MBR735	35	7.5	125	150	0.55	7.5	1.0	35
MBR740	40	7.5	125	150	0.55	7.5	1.0	40
MBR745	45	7.5	125	150	0.55	7.5	1.0	45
MBR750	50	7.5	125	150	0.70	7.5	1.0	50
MBR760	60	7.5	125	150	0.70	7.5	1.0	60

8.0A Schottky Rectifiers / DO-201AD



SD830	30	8.0	90*	175	0.55	8.0	1.0	30
SD840	40	8.0	90*	175	0.55	8.0	1.0	40
SD845	45	8.0	90*	175	0.55	8.0	1.0	45



* TL, Lead Temperature at a distance of 9.5mm from case.

8.0A Schottky Rectifiers / TO-220AC





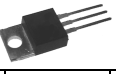

SBL830	30	8.0	95	200	0.55	8.0	0.5	30
SBL835	35	8.0	95	200	0.55	8.0	0.5	35
SBL840	40	8.0	95	200	0.55	8.0	0.5	40
SBL845	45	8.0	95	200	0.55	8.0	0.5	45
SBL850	50	8.0	95	200	0.70	8.0	0.5	50
SBL860	60	8.0	95	200	0.70	8.0	0.5	60
SBL870	70	8.0	110	175	0.85	8.0	0.1	70
SBL880	80	8.0	110	175	0.85	8.0	0.1	80
SBL890	90	8.0	110	175	0.85	8.0	0.1	90
SBL8100	100	8.0	110	175	0.85	8.0	0.1	100





(†) Reference product datasheet for specific test conditions.

Type Number	Peak Repetitive Reverse Voltage	Maximum Average Rectified Current (†)		Maximum Peak Forward Surge Current (†)	Forward Voltage Drop		Maximum Reverse Current (†)	
	V_{RRM}	$I_O @ T_T$		I_{FSM}	$V_F @ I_F$		$I_R @ V_R$	
	V	A	°C	A	V	A	mA	V
9.0A Schottky Rectifiers / DO-201AD  NEW								
SD930	30	9.0	120	340	0.48	9.0	0.8	30
SD940	40	9.0	120	340	0.48	9.0	0.8	40
SD945	45	9.0	120	340	0.48	9.0	0.8	45
10A Schottky Rectifiers / D²PAK  NEW								
SBG1025L	30	10	125	100	0.45	10	5.0	30
SBG1030CT	30	10	95	125	0.55	5.0	1.0	30
SBG1035CT	35	10	95	125	0.55	5.0	1.0	35
SBG1040CT	40	10	95	125	0.55	5.0	1.0	40
SBG1045CT	45	10	95	125	0.55	5.0	1.0	45
10A Schottky Rectifiers / TO-220AC 								
MBR1030	30	10	125	150	0.84	10	0.1	30
MBR1035	35	10	125	150	0.84	10	0.1	35
MBR1040	40	10	125	150	0.84	10	0.1	40
MBR1045	45	10	125	150	0.84	10	0.1	45
MBR1050	50	10	125	150	0.95	10	0.1	50
MBR1060	60	10	125	150	0.95	10	0.1	60
SBL1030	30	10	95	250	0.60	10	1.0	30
SBL1035	35	10	95	250	0.60	10	1.0	35
SBL1040	40	10	95	250	0.60	10	1.0	40
SBL1045	45	10	95	250	0.60	10	1.0	45
SBL1050	50	10	95	250	0.75	10	1.0	50
SBL1060	60	10	95	250	0.75	10	1.0	60
10A Schottky Rectifiers (DUAL) / TO-220AB 								
SBL1030CT	30	10	95	175	0.55	10	0.5	30
SBL1035CT	35	10	95	175	0.55	10	0.5	35
SBL1040CT	40	10	95	175	0.55	10	0.5	40
SBL1045CT	45	10	95	175	0.55	10	0.5	45
SBL1050CT	50	10	95	175	0.70	10	0.5	50
SBL1060CT	60	10	95	175	0.70	10	0.5	60
MBR1030CT ^{NEW}	30	10	105	125	0.84	10	0.1	30
MBR1035CT ^{NEW}	35	10	105	125	0.84	10	0.1	35
MBR1040CT ^{NEW}	40	10	105	125	0.84	10	0.1	40
MBR1045CT ^{NEW}	45	10	105	125	0.84	10	0.1	45
MBR1050CT ^{NEW}	50	10	105	125	0.95	10	0.1	50
MBR1060CT ^{NEW}	60	10	105	125	0.95	10	0.1	60
MBR1070CT ^{NEW}	70	10	100	120	0.95	10	0.1	70
MBR1080CT ^{NEW}	80	10	100	120	0.95	10	0.1	80
MBR1090CT ^{NEW}	90	10	100	120	0.95	10	0.1	90
MBR10100CT ^{NEW}	100	10	100	120	0.95	10	0.1	100

(†) Reference product datasheet for specific test conditions.

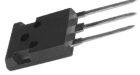
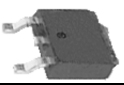
Type Number	Peak Repetitive Reverse Voltage	Maximum Average Rectified Current (†)		Maximum Peak Forward Surge Current (†)	Forward Voltage Drop		Maximum Reverse Current (†)	
	V _{RRM}	I _O @ T _T		I _{FSM}	V _F @ I _F		I _R @ V _R	
	V	A	°C	A	V	A	mA	V
15A Schottky Rectifiers (DUAL) / D²PAK 								
MBRB1530CT	30	15	105	150	0.70	7.5	0.1	30
MBRB1535CT	35	15	105	150	0.70	7.5	0.1	35
MBRB1540CT	40	15	105	150	0.70	7.5	0.1	40
MBRB1545CT	45	15	105	150	0.70	7.5	0.1	45
15A Schottky Rectifiers (DUAL) / TO-220AB 								
MBR1530CT	30	15	125	150	0.84	15	0.1	30
MBR1535CT	35	15	125	150	0.84	15	0.1	35
MBR1540CT	40	15	125	150	0.84	15	0.1	40
MBR1545CT	45	15	125	150	0.84	15	0.1	45
MBR1550CT	50	15	125	150	0.90	15	1.0	50
MBR1560CT	60	15	125	150	0.90	15	1.0	60
16A Schottky Rectifiers (DUAL) / D²PAK <i>NEW</i> 								
SBG1630CT	30	16	95	175	0.55	8.0	1.0	30
SBG1635CT	35	16	95	175	0.55	8.0	1.0	35
SBG1640CT	40	16	95	175	0.55	8.0	1.0	40
SBG1645CT	45	16	95	175	0.55	8.0	1.0	45
16A Schottky Rectifiers / TO-220AC 								
MBR1630	30	16	125	150	0.63	16	0.2	30
MBR1635	35	16	125	150	0.63	16	0.2	35
MBR1640	40	16	125	150	0.63	16	0.2	40
MBR1645	45	16	125	150	0.63	16	0.2	45
MBR1650	50	16	125	150	0.75	16	1.0	50
MBR1660	60	16	125	150	0.75	16	1.0	60
SBL1630	30	16	95	275	0.57	16	1.0	30
SBL1635	35	16	95	275	0.57	16	1.0	35
SBL1640	40	16	95	275	0.57	16	1.0	40
SBL1645	45	16	95	275	0.57	16	1.0	45
SBL1650	50	16	95	275	0.75	16	1.0	50
SBL1660	60	16	95	275	0.75	16	1.0	60
16A Schottky Rectifiers / TO-220AB 								
SBL1630CT	30	16	95	250	0.55	8.0	0.5	30
SBL1635CT	35	16	95	250	0.55	8.0	0.5	35
SBL1640CT	40	16	95	250	0.55	8.0	0.5	40
SBL1645CT	45	16	95	250	0.55	8.0	0.5	45
SBL1650CT	50	16	95	250	0.70	8.0	0.5	50
SBL1660CT	60	16	95	250	0.70	8.0	0.5	60

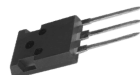
(†) Reference product datasheet for specific test conditions.

Type Number	Peak Repetitive Reverse Voltage	Maximum Average Rectified Current (†)		Maximum Peak Forward Surge Current (†)	Forward Voltage Drop		Maximum Reverse Current (†)	
	V_{RRM}	$I_O @ T_T$		I_{FSM}	$V_F @ I_F$		$I_R @ V_R$	
	V	A	°C	A	V	A	mA	V
16A Schottky Rectifiers (DUAL) / TO-3P 								
SBL1630PT	30	16	95	250	0.55	8.0	0.5	30
SBL1635PT	35	16	95	250	0.55	8.0	0.5	35
SBL1640PT	40	16	95	250	0.55	8.0	0.5	40
SBL1645PT	45	16	95	250	0.55	8.0	0.5	45
SBL1650PT	50	16	95	250	0.70	8.0	0.5	50
SBL1660PT	60	16	95	250	0.70	8.0	0.5	60
20A Schottky Rectifiers (DUAL) / D²PAK <i>NEW</i> 								
SBG2030CT	30	20	105	225	0.55	10	1.0	30
SBG2035CT	35	20	105	225	0.55	10	1.0	35
SBG2040CT	40	20	105	225	0.55	10	1.0	40
SBG2045CT	45	20	105	225	0.55	10	1.0	45
20A Schottky Rectifiers (DUAL) / TO-220AB 								
MBR2030CT	30	20	125	150	0.84	10	0.1	30
MBR2035CT	35	20	125	150	0.84	10	0.1	35
MBR2040CT	40	20	125	150	0.84	10	0.1	40
MBR2045CT	45	20	125	150	0.84	10	0.1	45
MBR2050CT	50	20	125	150	0.95	10	0.1	50
MBR2060CT	60	20	125	150	0.95	10	0.1	60
MBR2070CT <i>NEW</i>	70	20	125	150	0.95	20	0.15	70
MBR2080CT <i>NEW</i>	80	20	125	150	0.95	20	0.15	80
MBR2090CT <i>NEW</i>	90	20	125	150	0.95	20	0.15	90
MBR20100CT <i>NEW</i>	100	20	125	150	0.95	20	0.15	100
SBL2030CT	30	20	95	250	0.55	10	1.0	30
SBL2035CT	35	20	95	250	0.55	10	1.0	35
SBL2040CT	40	20	95	250	0.55	10	1.0	40
SBL2045CT	45	20	95	250	0.55	10	1.0	45
SBL2050CT	50	20	95	250	0.75	10	1.0	50
SBL2060CT	60	20	95	250	0.75	10	1.0	60
20A Schottky Rectifiers (DUAL) / TO-3P 								
SBL2030PT	30	20	100	250	0.55	10	1.0	30
SBL2035PT	35	20	100	250	0.55	10	1.0	35
SBL2040PT	40	20	100	250	0.55	10	1.0	40
SBL2045PT	45	20	100	250	0.55	10	1.0	45
SBL2050PT	50	20	100	250	0.75	10	1.0	50
SBL2060PT	60	20	100	250	0.75	10	1.0	60
30A Schottky Rectifiers (DUAL) / D²PAK <i>NEW</i> 								
SBG3030CT	30	30	100	250	0.55	15	1.0	30
SBG3040CT	40	30	100	250	0.55	15	1.0	40
SBG3050CT	50	30	100	250	0.70	15	1.0	50
SBG3060CT	60	30	100	250	0.70	15	1.0	60

(†) Reference product datasheet for specific test conditions.

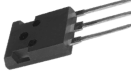
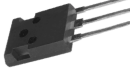
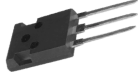
Type Number	Peak Repetitive Reverse Voltage	Maximum Average Rectified Current (†)		Maximum Peak Forward Surge Current (†)	Forward Voltage Drop		Maximum Reverse Current (†)		
	V_{RRM}	$I_O @ T_T$		I_{FSM}	$V_F @ I_F$		$I_R @ V_R$		
	V	A	°C	A	V	A	mA	V	
30A Schottky Rectifiers (DUAL) / TO-220AB  NEW									
MBR2535CT	35	30	130	150	0.82	30	1.0	35	
MBR2545CT	45	30	130	150	0.82	30	1.0	45	
MBR2550CT	50	30	130	150	0.75	15	1.0	50	
MBR2560CT	60	30	130	150	0.75	15	1.0	60	
SBL3030CT	30	30	100	250	0.55	15	1.0	30	
SBL3040CT	40	30	100	250	0.55	15	1.0	40	
SBL3045CT	45	30	100	250	0.55	15	1.0	45	
SBL3050CT	50	30	100	250	0.70	15	1.0	50	
SBL3060CT	60	30	100	250	0.70	15	1.0	60	
30A Schottky Rectifiers (DUAL) / TO-3P 									
MBR3030PT	30	30	125	200	0.76	15	1.0	30	
MBR3035PT	35	30	125	200	0.76	15	1.0	35	
MBR3040PT	40	30	125	200	0.76	15	1.0	40	
MBR3045PT	45	30	125	200	0.76	15	1.0	45	
MBR3050PT	50	30	125	200	0.80	15	5.0	50	
MBR3060PT	60	30	125	200	0.80	15	5.0	60	
SBL3030PT	30	30	95	275	0.55	15	1.0	30	
SBL3035PT	35	30	95	275	0.55	15	1.0	35	
SBL3040PT	40	30	95	275	0.55	15	1.0	40	
SBL3045PT	45	30	95	275	0.55	15	1.0	45	
SBL3050PT	50	30	95	275	0.70	15	1.0	50	
SBL3060PT	60	30	95	275	0.70	15	1.0	60	
40A Schottky Rectifiers (DUAL) / TO-3P 									
MBR4030PT	30	40	125	400	0.70	20	1.0	30	
MBR4035PT	35	40	125	400	0.70	20	1.0	35	
MBR4040PT	40	40	125	400	0.70	20	1.0	40	
MBR4045PT	45	40	125	400	0.70	20	1.0	45	
MBR4050PT	50	40	125	400	0.80	20	1.0	50	
MBR4060PT	60	40	125	400	0.80	20	1.0	60	
60A Schottky Rectifiers (DUAL) / TO-3P  NEW									
MBR6030PT	30	60	125	500	0.75	60	1.0	30	
MBR6035PT	35	60	125	500	0.75	60	1.0	35	
MBR6040PT	40	60	125	500	0.75	60	1.0	40	
MBR6045PT	45	60	125	500	0.75	60	1.0	45	
SBL6030PT	30	60	100	500	0.55	30	20	30	
SBL6040PT	40	60	100	500	0.55	30	20	40	
SBL6050PT	50	60	100	500	0.70	30	20	50	
SBL6060PT	60	60	100	500	0.70	30	20	60	

(†) Reference product datasheet for specific test conditions.

Switching Diodes

Type Number	Peak Repetitive Reverse Voltage	Reverse Recovery Time (†)	Max. Average Rectified Current (†)	Max. Peak Forward Surge Current (†)	Forward Voltage Drop		Max. Reverse Current		Pin-out Config.
	V_{RRM}	t_{rr}	I_O	I_{FSM}	$V_F @ I_F$		$I_R @ V_R$		
	V	ns	mA	A	V	mA	μA	V	

200mW Switching Diodes / SOT-323

NEW

BAS16W	75	4.0	150	2.0	1.0	50	1.0	75	Fig.1
BAS19W	120	50	200	2.5	1.0	100	0.1	100	Fig.1
BAS20W	200	50	200	2.5	1.0	100	0.1	150	Fig.1
BAS21W	250	50	200	2.5	1.0	100	0.1	200	Fig.1
BAV70W	75	4.0	150	2.0	1.0	50	2.5	75	Fig.3
BAV99W	75	4.0	150	2.0	1.0	50	2.5	75	Fig.4
BAW56W	75	4.0	150	2.0	1.0	50	2.5	75	Fig.2
MMBD4148W	75	4.0	150	2.0	1.0	50	1.0	75	Fig.1
MMBD4448W	75	4.0	250	4.0	1.0	100	2.5	75	Fig.1

350mW Switching Diodes / SOT-23

BAL99	75	4.0	150	2.0	1.0	50	2.5	75	Fig. 5
BAW56	75	4.0	150	2.0	1.0	50	2.5	75	Fig. 2
BAV70	75	4.0	150	2.0	1.0	50	2.5	75	Fig. 3
BAV99	75	4.0	150	2.0	1.0	50	2.5	75	Fig. 4
BAS16	75	4.0	150	2.0	1.0	50	1.0	75	Fig. 1
MMBD914 _{NEW}	75	4.0	150	2.0	1.0	50	2.5	75	Fig. 1
MMBD4148	75	4.0	150	2.0	1.0	50	2.5	75	Fig. 1
MMBD4448	75	4.0	250	4.0	1.0	100	2.5	75	Fig. 1
MMBD7000 _{NEW}	75	4.0	150	2.0	1.25	150	1.0	50	Fig. 4
BAS19*	120	50	200	2.5	1.0	100	0.1	100	Fig. 1
BAS20*	200	50	200	2.5	1.0	100	0.1	150	Fig. 1
BAS21*	250	50	200	2.5	1.0	100	0.1	200	Fig. 1
BAS31 _{NEW}	75	4.0	250	4.0	1.0	100	2.5	75	Fig.4
BAV23S* _{NEW}	250	50	200	3.0	1.0	100	0.1	200	Fig.4

*Power Dissipation (Pd) = 250mW

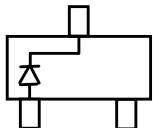

Figure 1, Single

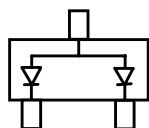

Figure 2, Common Anode

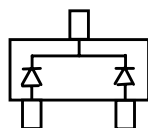

Figure 3, Common Cathode

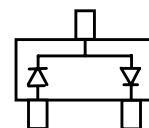

Figure 4, Series

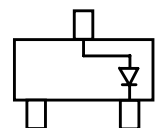

Figure 5, Single (Alt.)

(†) Reference product datasheet for specific test conditions.

Type Number	Peak Repetitive Reverse Voltage	Reverse Recovery Time (t)	Max. Average Rectified Current (t)	Max. Peak Forward Surge Current (t)	Forward Voltage Drop		Max. Reverse Current (t)	
	V_{RRM}	t_{rr}	I_o	I_{FSM}	$V_F @ I_F$		$I_R @ V_R$	
	V	ns	mA	A	V	mA	μA	V

200mW Switching Diodes / SOD-323

Type Number	Peak Repetitive Reverse Voltage	Reverse Recovery Time (t)	Max. Average Rectified Current (t)	Max. Peak Forward Surge Current (t)	Forward Voltage Drop	Max. Reverse Current (t)
1N4148WS	75	4.0	150	2.0	1.0 50	1.0 75
1N4448WS	75	4.0	250	4.0	1.0 100	2.5 75
BAV16WS	75	4.0	150	2.0	1.0 50	1.0 75
BAV19WS	120	50	200	2.5	1.0 100	0.1 100
BAV20WS	200	50	200	2.5	1.0 100	0.1 150
BAV21WS	250	50	200	2.5	1.0 100	0.1 200

250mW Switching Diodes / SOD-123

Type Number	Peak Repetitive Reverse Voltage	Reverse Recovery Time (t)	Max. Average Rectified Current (t)	Max. Peak Forward Surge Current (t)	Forward Voltage Drop	Max. Reverse Current (t)
BAV19W	120	50	200	2.5	1.0 100	0.1 100
BAV20W	200	50	200	2.5	1.0 100	0.1 150
BAV21W	250	50	200	2.5	1.0 100	0.1 200

350mW Switching Diodes / SOD-123

Type Number	Peak Repetitive Reverse Voltage	Reverse Recovery Time (t)	Max. Average Rectified Current (t)	Max. Peak Forward Surge Current (t)	Forward Voltage Drop	Max. Reverse Current (t)
1N4148W	75	4.0	150	2.0	1.0 50	2.5 75
1N4448W	75	4.0	250	4.0	1.0 100	2.5 70
BAV16W	75	4.0	150	2.0	1.0 50	1.0 75

500mW Switching Diodes / Micro-MELF

Type Number	Peak Repetitive Reverse Voltage	Reverse Recovery Time (t)	Max. Average Rectified Current (t)	Max. Peak Forward Surge Current (t)	Forward Voltage Drop	Max. Reverse Current (t)
BAV301	120	50	125	1.0	1.0 100	0.1 100
BAV302	200	50	125	1.0	1.0 100	0.1 150
BAV303	250	50	125	1.0	1.0 100	0.1 200
MCL4154	25	2.0	100	2.0	1.0 30	0.1 25
MCL4151	50	2.0	100	2.0	1.0 50	0.05 50
MCL4148	75	4.0	100	2.0	1.0 50	5.0 75
MCL4448	75	4.0	100	2.0	1.0 100	5.0 75

500mW Switching Diodes / Quadro-MELF

Type Number	Peak Repetitive Reverse Voltage	Reverse Recovery Time (t)	Max. Average Rectified Current (t)	Max. Peak Forward Surge Current (t)	Forward Voltage Drop	Max. Reverse Current (t)
LS4154	25	2.0	150	2.0	1.0 30	0.1 25
LS4150	35	4.0	300	4.0	1.0 200	0.1 50
LS4151	50	2.0	150	2.0	1.0 50	0.05 50
LS4148	75	4.0	150	2.0	1.0 50	5.0 75
LS4448	75	4.0	150	2.0	1.0 100	5.0 75
BAV201	120	50	125	1.0	1.0 100	0.1 100
BAV202	200	50	125	1.0	1.0 100	0.1 150
BAV203	250	50	125	1.0	1.0 100	0.1 200

(t) Reference product datasheet for specific test conditions.

Type Number	Peak Repetitive Reverse Voltage	Reverse Recovery Time (†)	Max. Average Rectified Current (†)	Max. Peak Forward Surge Current (†)	Forward Voltage Drop		Max. Reverse Current (†)	
	V_{RRM}	t_{rr}	I_O	I_{FSM}	$V_F @ I_F$		$I_R @ V_R$	
	V	ns	mA	A	V	mA	μA	V

500mW Switching Diodes / Mini-MELF



LL4154	35	4.0	150	2.0	1.0	30	0.1	25
LL4151	50	4.0	150	2.0	1.0	50	0.05	50
LL4150	50	6.0	200	4.0	1.0	200	0.1	50
LL4148	75	4.0	150	2.0	1.0	10	5.0	75
LL4448	75	4.0	150	2.0	1.0	100	5.0	75
BAV101	120	50	125	1.0	1.0	100	0.1	100
BAV102	200	50	125	1.0	1.0	100	0.1	150
BAV103	250	50	125	1.0	1.0	100	0.1	200

500mW Switching Diodes / DO-35



1N4154	25	4.0	150	2.0	1.0	30	0.1	25
1N4151	50	4.0	150	2.0	1.0	50	0.05	50
1N4150	50	6.0	200	4.0	1.0	200	0.1	50
1N4148	75	4.0	150	2.0	1.0	10	5.0	75
1N4448	75	4.0	150	2.0	1.0	100	5.0	75
BAV20	200	50	200	1.0	1.0	100	0.1	150
BAV21	250	50	200	1.0	1.0	100	0.1	200

(†) Reference product datasheet for specific test conditions.

Super-/Ultra Fast Recovery Rectifiers

Type Number	Peak Repetitive Reverse Voltage	Reverse Recovery Time (t)	Max. Average Rectified Current (t)		Max. Peak Forward Surge Current (t)	Forward Voltage Drop		Max. Reverse Current (t)	
	V _{R_{RM}}	t _{rr}	I _O @ T _T		I _{FSM}	V _F @ I _F		I _R @ V _R	
	V	ns	A	°C	A	V	A	μA	V

1.0A Super-/Ultra-Fast Recovery Glass Passivated Rectifiers / SMA



ES1A	50	20	1.0	110	30	0.98	1.0	5.0	50
ES1B	100	20	1.0	110	30	0.98	1.0	5.0	100
ES1C	150	20	1.0	110	30	0.98	1.0	5.0	150
ES1D	200	20	1.0	110	30	0.98	1.0	5.0	200
ES1G	400	20	1.0	110	30	1.25	1.0	5.0	400
US1A	50	50	1.0	75	30	1.0	1.0	5.0	50
US1B	100	50	1.0	75	30	1.0	1.0	5.0	100
US1D	200	50	1.0	75	30	1.0	1.0	5.0	200
US1G	400	50	1.0	75	30	1.3	1.0	5.0	400
US1J	600	75	1.0	75	30	1.7	1.0	5.0	600
US1K	800	75	1.0	75	30	1.7	1.0	5.0	800
US1M	1000	75	1.0	75	30	1.7	1.0	5.0	1000

1.0A Super-/Ultra-Fast Recovery Rectifiers / DO-41



UF1001	50	50	1.0	55*	30	1.0	1.0	5.0	50
UF1002	100	50	1.0	55*	30	1.0	1.0	5.0	100
UF1003	200	50	1.0	55*	30	1.0	1.0	5.0	200
UF1004	400	50	1.0	55*	30	1.3	1.0	5.0	400
UF1005	600	75	1.0	55*	30	1.7	1.0	5.0	600
UF1006	800	75	1.0	55*	30	1.7	1.0	5.0	800
UF1007	1000	75	1.0	55*	30	1.7	1.0	5.0	1000

* TA, Ambient Temperature

1.0A Super-/Ultra-Fast Recovery Glass Passivated Rectifiers / DO-41



SF10AG	50	35	1.0	75*	30	0.95	1.0	10	50
SF10BG	100	35	1.0	75*	30	0.95	1.0	10	100
SF10CG	150	35	1.0	75*	30	0.95	1.0	10	150
SF10DG	200	35	1.0	75*	30	0.95	1.0	10	200
SF10FG	300	40	1.0	75*	30	1.3	1.0	10	300
SF10GG	400	40	1.0	75*	30	1.3	1.0	10	400
SF10HG	500	50	1.0	75*	30	1.5	1.0	10	500
SF10JG	600	50	1.0	75*	30	1.5	1.0	10	600
MUR140 <small>NEW</small>	400	50	1.0	120	35	1.25	1.0	5.0	400
MUR160 <small>NEW</small>	600	50	1.0	120	35	1.25	1.0	5.0	600
UG1001	50	50	1.0	55*	30	1.0	1.0	5.0	50
UG1002	100	50	1.0	55*	30	1.0	1.0	5.0	100
UG1003	200	50	1.0	55*	30	1.0	1.0	5.0	200
UG1004	400	50	1.0	55*	30	1.3	1.0	5.0	400
UG1005	600	75	1.0	55*	30	1.7	1.0	5.0	600

(t) Reference product datasheet for specific test conditions.

Type Number	Peak Repetitive Reverse Voltage	Reverse Recovery Time (†)	Max. Average Rectified Current (†)		Max. Peak Forward Surge Current (†)	Forward Voltage Drop		Max. Reverse Current (†)	
	V_{RRM}	t_{rr}	$I_O @ T_A$		I_{FSM}	$V_F @ I_F$		$I_R @ V_R$	
	V	ns	A	°C	A	V	A	μA	V

NEW



1.0A Super-/Ultra-Fast Recovery Glass Passivated Rectifiers / SMB

MURS140	400	50	1.0	120	35	1.25	1.0	5.0	400
MURS160	600	50	1.0	120	35	1.25	1.0	5.0	600

1.5A Super-/Ultra-Fast Recovery Rectifiers / DO-15



UF1501	50	50	1.5	50	50	1.0	1.5	5.0	50
UF1502	100	50	1.5	50	50	1.0	1.5	5.0	100
UF1503	200	50	1.5	50	50	1.0	1.5	5.0	200
UF1504	400	50	1.5	50	50	1.3	1.5	5.0	400
UF1505	600	75	1.5	50	50	1.7	1.5	5.0	600
UF1506	800	75	1.5	50	50	1.7	1.5	5.0	800
UF1507	1000	75	1.5	50	50	1.7	1.5	5.0	1000

1.5A Super-/Ultra-Fast Recovery Rectifiers / DO-41



UF1501S	50	50	1.5	50	50	1.0	1.5	5.0	50
UF1502S	100	50	1.5	50	50	1.0	1.5	5.0	100
UF1503S	200	50	1.5	50	50	1.0	1.5	5.0	200
UF1504S	400	50	1.5	50	50	1.3	1.5	5.0	400
UF1505S	600	75	1.5	50	50	1.7	1.5	5.0	600
UF1506S	800	75	1.5	50	50	1.7	1.5	5.0	800
UF1507S	1000	75	1.5	50	50	1.7	1.5	5.0	1000

2.0A Super-/Ultra-Fast Recovery Glass Passivated Rectifiers / SMA



ES2AA	50	25	2.0	110*	50	0.9	2.0	5.0	50
ES2BA	100	25	2.0	110*	50	0.9	2.0	5.0	100
ES2CA	150	25	2.0	110*	50	0.9	2.0	5.0	150
ES2DA	200	25	2.0	110*	50	0.9	2.0	5.0	200

* T_T , Terminal Temperature

2.0A Super-/Ultra-Fast Recovery Glass Passivated Rectifiers / SMB

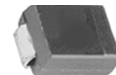

ES2A	50	25	2.0	110*	50	0.9	2.0	5.0	50
ES2B	100	25	2.0	110*	50	0.9	2.0	5.0	100
ES2C	150	25	2.0	110*	50	0.9	2.0	5.0	150
ES2D	200	25	2.0	110*	50	0.9	2.0	5.0	200

* T_T , Terminal Temperature

(†) Reference product datasheet for specific test conditions.

Type Number	Peak Repetitive Reverse Voltage	Reverse Recovery Time (†)	Max. Average Rectified Current (†)		Max. Peak Forward Surge Current (†)	Forward Voltage Drop		Max. Reverse Current (†)	
	V _{RRM}	t _{rr}	I _O @ T _A		I _{FSM}	V _F @ I _F		I _R @ V _R	
	V	ns	A	°C	A	V	A	µA	V

2.0A Super-/Ultra-Fast Recovery Rectifiers / DO-15



UF2001	50	50	2.0	50	60	1.0	2.0	5.0	50
UF2002	100	50	2.0	50	60	1.0	2.0	5.0	100
UF2003	200	50	2.0	50	60	1.0	2.0	5.0	200
UF2004	400	50	2.0	50	60	1.3	2.0	5.0	400
UF2005	600	75	2.0	50	60	1.7	2.0	5.0	600
UF2006	800	75	2.0	50	60	1.7	2.0	5.0	800
UF2007	1000	75	2.0	50	60	1.7	2.0	5.0	1000

2.0A Super-/Ultra-Fast Glass Passivated Recovery Rectifiers / DO-15



SF20AG	50	35	2.0	75	60	0.95	2.0	10	50
SF20BG	100	35	2.0	75	60	0.95	2.0	10	100
SF20CG	150	35	2.0	75	60	0.95	2.0	10	150
SF20DG	200	35	2.0	75	60	0.95	2.0	10	200
SF20FG	300	40	2.0	75	60	1.3	2.0	10	300
SF20GG	400	40	2.0	75	60	1.3	2.0	10	400
SF20HG	500	50	2.0	75	60	1.5	2.0	10	500
SF20JG	600	50	2.0	75	60	1.5	2.0	10	600
UG2001	50	50	2.0	55	60	1.0	2.0	8.0	50
UG2002	100	50	2.0	55	60	1.0	2.0	8.0	100
UG2003	200	50	2.0	55	60	1.0	2.0	8.0	200
UG2004	400	50	2.0	55	60	1.3	2.0	8.0	400
UG2005	600	50	2.0	55	60	1.7	2.0	8.0	600

3.0A Super-/Ultra-Fast Glass Passivated Recovery Rectifiers / SMB



ES3AB	50	25	3.0	100*	100	0.9	3.0	10	50
ES3BB	100	25	3.0	100*	100	0.9	3.0	10	100
ES3CB	150	25	3.0	100*	100	0.9	3.0	10	150
ES3DB	200	25	3.0	100*	100	0.9	3.0	10	200

*T_T, Terminal Temperature

3.0A Super-/Ultra-Fast Glass Passivated Recovery Rectifiers / SMC



ES3A	50	25	3.0	100*	100	0.9	3.0	10	50
ES3B	100	25	3.0	100*	100	0.9	3.0	10	100
ES3C	150	25	3.0	100*	100	0.9	3.0	10	150
ES3D	200	25	3.0	100*	100	0.9	3.0	10	200

*T_T, Terminal Temperature

(†) Reference product datasheet for specific test conditions.

Type Number	Peak Repetitive Reverse Voltage	Reverse Recovery Time (†)	Max. Average Rectified Current (†)		Max. Peak Forward Surge Current (†)	Forward Voltage Drop		Max. Reverse Current (†)	
	V_{RRM}	t_{rr}	$I_O @ T_C$		I_{FSM}	$V_F @ I_F$		$I_R @ V_R$	
	V	ns	A	°C	A	V	A	μA	V

3.0A Super-/Ultra-Fast Recovery Glass Passivated Rectifiers DO-201AD



SF30AG	50	35	3.0	55	125	0.95	3.0	5.0	50
SF30BG	100	35	3.0	55	125	0.95	3.0	5.0	100
SF30CG	150	35	3.0	55	125	0.95	3.0	5.0	150
SF30DG	200	35	3.0	55	125	0.95	3.0	5.0	200
SF30FG	300	40	3.0	55	125	1.3	3.0	5.0	300
SF30GG	400	40	3.0	55	125	1.3	3.0	5.0	400
SF30HG	500	50	3.0	55	125	1.5	3.0	5.0	500
SF30JG	600	50	3.0	55	125	1.5	3.0	5.0	600
UG3001	50	50	3.0	55	125	0.95	3.0	5.0	50
UG3002	100	50	3.0	55	125	0.95	3.0	5.0	100
UG3003	200	50	3.0	55	125	0.95	3.0	5.0	200
UG3004	400	50	3.0	55	125	1.25	3.0	5.0	400
UG3005	600	75	3.0	55	125	1.7	3.0	5.0	600

3.0A Super-/Ultra-Fast Recovery Rectifiers / DO-201AD



UF3001	50	50	3.0	55	150	1.0	3.0	5.0	50
UF3002	100	50	3.0	55	150	1.0	3.0	5.0	100
UF3003	200	50	3.0	55	150	1.0	3.0	5.0	200
UF3004	400	50	3.0	55	150	1.3	3.0	5.0	400
UF3005	600	75	3.0	55	150	1.7	3.0	5.0	600
UF3006	800	75	3.0	55	150	1.7	3.0	5.0	800
UF3007	1000	75	3.0	55	150	1.7	3.0	5.0	1000

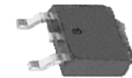

16A Super-/Ultra-Fast Recovery Glass Passivated Rectifiers (DUAL) D²PAK



MURB1610CT	100	25	16	125	100	0.975	8.0	5.0	100
MURB1620CT	200	25	16	125	100	0.975	8.0	5.0	200

(†) Reference product datasheet for specific test conditions.

Fast Recovery Rectifiers

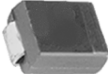
Type Number	Peak Repetitive Reverse Voltage	Reverse Recovery Time (t)	Max. Average Rectified Current		Max. Peak Forward Surge Current	Forward Voltage Drop		Max. Reverse Current	
	V _{RRM}	t _{rr}	I _O @ T _T		I _{FSM}	V _F @ I _F		I _R @ V _R	
	V	ns	A	°C	A	V	A	μA	V
1.0A Fast Recovery Glass Passivated Rectifiers / MELF 									
DL4933	50	200	1.0	75	30	1.2	1.0	5.0	50
DL4934	100	200	1.0	75	30	1.2	1.0	5.0	100
DL4935	200	200	1.0	75	30	1.2	1.0	5.0	200
DL4936	400	200	1.0	75	30	1.2	1.0	5.0	400
DL4937	600	200	1.0	75	30	1.2	1.0	5.0	600
1.0A Fast Recovery Glass Passivated Rectifiers / SMA 									
RS1A	50	150	1.0	120	30	1.3	1.0	5.0	50
RS1B	100	150	1.0	120	30	1.3	1.0	5.0	100
RS1D	200	150	1.0	120	30	1.3	1.0	5.0	200
RS1G	400	150	1.0	120	30	1.3	1.0	5.0	400
RS1J	600	250	1.0	120	30	1.3	1.0	5.0	600
RS1K	800	500	1.0	120	30	1.3	1.0	5.0	800
RS1M	1000	500	1.0	120	30	1.3	1.0	5.0	1000
1.0A Fast Recovery Glass Passivated Rectifiers / SMB 									
RS1AB	50	150	1.0	120	30	1.3	1.0	5.0	50
RS1BB	100	150	1.0	120	30	1.3	1.0	5.0	100
RS1DB	200	150	1.0	120	30	1.3	1.0	5.0	200
RS1GB	400	150	1.0	120	30	1.3	1.0	5.0	400
RS1JB	600	250	1.0	120	30	1.3	1.0	5.0	600
RS1KB	800	500	1.0	120	30	1.3	1.0	5.0	800
RS1MB	1000	500	1.0	120	30	1.3	1.0	5.0	1000

(t) Reference product datasheet for specific test conditions.

Type Number	Peak Repetitive Reverse Voltage	Reverse Recovery Time (t)	Max. Average Rectified Current		Max. Peak Forward Surge Current	Forward Voltage Drop		Max. Reverse Current	
	V _{R_{RM}}	t _{rr}	I _O @ T _A		I _{FSM}	V _F @ I _F		I _R @ V _R	
	V	ns	A	°C	A	V	A	μA	V

1.0A Fast Recovery Rectifiers / DO-41



PR1001	50	150	1.0	75	30	1.2	1.0	5.0	50
PR1002	100	150	1.0	75	30	1.2	1.0	5.0	100
PR1003	200	150	1.0	75	30	1.2	1.0	5.0	200
PR1004	400	150	1.0	75	30	1.2	1.0	5.0	400
PR1005	600	250	1.0	75	30	1.2	1.0	5.0	600
1N4933	50	200	1.0	75	30	1.2	1.0	5.0	50
1N4934	100	200	1.0	75	30	1.2	1.0	5.0	100
1N4935	200	200	1.0	75	30	1.2	1.0	5.0	200
1N4936	400	200	1.0	75	30	1.2	1.0	5.0	400
1N4937	600	200	1.0	75	30	1.2	1.0	5.0	600

1.0A Fast Recovery Glass Passivated Rectifiers / DO-41



PR1001G	50	150	1.0	55	30	1.3	1.0	5.0	50
PR1002G	100	150	1.0	55	30	1.3	1.0	5.0	100
PR1003G	200	150	1.0	55	30	1.3	1.0	5.0	200
PR1004G	400	150	1.0	55	30	1.3	1.0	5.0	400
PR1005G	600	250	1.0	55	30	1.3	1.0	5.0	600
PR1006G	800	500	1.0	55	30	1.3	1.0	5.0	800
PR1007G	1000	500	1.0	55	30	1.3	1.0	5.0	1000
1N4933G	50	200	1.0	75	30	1.2	1.0	5.0	50
1N4934G	100	200	1.0	75	30	1.2	1.0	5.0	100
1N4935G	200	200	1.0	75	30	1.2	1.0	5.0	200
1N4936G	400	200	1.0	75	30	1.2	1.0	5.0	400
1N4937G	600	200	1.0	75	30	1.2	1.0	5.0	600

1.0A Fast Recovery Rectifiers / A-405



PR1001L	50	150	1.0	75	30	1.2	1.0	5.0	50
PR1002L	100	150	1.0	75	30	1.2	1.0	5.0	100
PR1003L	200	150	1.0	75	30	1.2	1.0	5.0	200
PR1004L	400	150	1.0	75	30	1.2	1.0	5.0	400
PR1005L	600	250	1.0	75	30	1.2	1.0	5.0	600
1N4933L	50	200	1.0	75	30	1.2	1.0	5.0	50
1N4934L	100	200	1.0	75	30	1.2	1.0	5.0	100
1N4935L	200	200	1.0	75	30	1.2	1.0	5.0	200
1N4936L	400	200	1.0	75	30	1.2	1.0	5.0	400
1N4937L	600	200	1.0	75	30	1.2	1.0	5.0	600

1.0A Fast Recovery Glass Passivated Rectifiers / A-405



PR1001GL	50	150	1.0	55	30	1.3	1.0	5.0	50
PR1002GL	100	150	1.0	55	30	1.3	1.0	5.0	100
PR1003GL	200	150	1.0	55	30	1.3	1.0	5.0	200
PR1004GL	400	150	1.0	55	30	1.3	1.0	5.0	400
PR1005GL	600	250	1.0	55	30	1.3	1.0	5.0	600
PR1006GL	800	500	1.0	55	30	1.3	1.0	5.0	800
PR1007GL	1000	500	1.0	55	30	1.3	1.0	5.0	1000

(†) Reference product datasheet for specific test conditions.

Type Number	Peak Repetitive Reverse Voltage	Reverse Recovery Time (t)	Max. Average Rectified Current		Max. Peak Forward Surge Current	Forward Voltage Drop		Max. Reverse Current	
	V _{R_{RM}}	t _{rr}	I _O @ T _T		I _{FSM}	V _F @ I _F		I _R @ V _R	
	V	ns	A	°C	A	V	A	μA	V

1.0A Fast Recovery Glass Passivated Rectifiers / A-405 (Continued)



1N4933GL	50	200	1.0	75	30	1.2	1.0	5.0	50
1N4934GL	100	200	1.0	75	30	1.2	1.0	5.0	100
1N4935GL	200	200	1.0	75	30	1.2	1.0	5.0	200
1N4936GL	400	200	1.0	75	30	1.2	1.0	5.0	400
1N4937GL	600	200	1.0	75	30	1.2	1.0	5.0	600

1.5A Fast Recovery Glass Passivated Rectifiers / SMA



RS2AA	50	150	1.5	120	50	1.3	1.5	5.0	50
RS2BA	100	150	1.5	120	50	1.3	1.5	5.0	100
RS2DA	200	150	1.5	120	50	1.3	1.5	5.0	200
RS2GA	400	150	1.5	120	50	1.3	1.5	5.0	400
RS2JA	600	250	1.5	120	50	1.3	1.5	5.0	600
RS2KA	800	500	1.5	120	50	1.3	1.5	5.0	800
RS2MA	1000	500	1.5	120	50	1.3	1.5	5.0	1000

1.5A Fast Recovery Glass Passivated Rectifiers / SMB



RS2A	50	150	1.5	120	50	1.3	1.5	5.0	50
RS2B	100	150	1.5	120	50	1.3	1.5	5.0	100
RS2D	200	150	1.5	120	50	1.3	1.5	5.0	200
RS2G	400	150	1.5	120	50	1.3	1.5	5.0	400
RS2J	600	250	1.5	120	50	1.3	1.5	5.0	600
RS2K	800	500	1.5	120	50	1.3	1.5	5.0	800
RS2M	1000	500	1.5	120	50	1.3	1.5	5.0	1000

1.5A Fast Recovery Rectifiers / DO-15



PR1501	50	150	1.5	50*	50	1.2	1.5	5.0	50
PR1502	100	150	1.5	50*	50	1.2	1.5	5.0	100
PR1503	200	150	1.5	50*	50	1.2	1.5	5.0	200
PR1504	400	150	1.5	50*	50	1.2	1.5	5.0	400
PR1505	600	250	1.5	50*	50	1.2	1.5	5.0	600

1.5A Fast Recovery Glass Passivated Rectifiers / DO-15



PR1501G	50	150	1.5	55*	50	1.3	1.5	5.0	50
PR1502G	100	150	1.5	55*	50	1.3	1.5	5.0	100
PR1503G	200	150	1.5	55*	50	1.3	1.5	5.0	200
PR1504G	400	150	1.5	55*	50	1.3	1.5	5.0	400
PR1505G	600	250	1.5	55*	50	1.3	1.5	5.0	600
PR1506G	800	500	1.5	55*	50	1.3	1.5	5.0	800
PR1507G	1000	500	1.5	55*	50	1.3	1.5	5.0	1000

* T_A, Ambient Temperature

(t) Reference product datasheet for specific test conditions.

Type Number	Peak Repetitive Reverse Voltage	Reverse Recovery Time (t)	Max. Average Rectified Current		Max. Peak Forward Surge Current	Forward Voltage Drop		Max. Reverse Current	
	V_{RRM}	t_{rr}	$I_O @ T_A$		I_{FSM}	$V_F @ I_F$		$I_R @ V_R$	
	V	ns	A	°C	A	V	A	μA	V

1.5A Fast Recovery Rectifiers / DO-41



PR1501S	50	150	1.5	50	50	1.2	1.5	5.0	50
PR1502S	100	150	1.5	50	50	1.2	1.5	5.0	100
PR1503S	200	150	1.5	50	50	1.2	1.5	5.0	200
PR1504S	400	150	1.5	50	50	1.2	1.5	5.0	400
PR1505S	600	250	1.5	50	50	1.2	1.5	5.0	600

1.5A Fast Recovery Glass Passivated Rectifiers / DO-41



PR1501GS	50	150	1.5	55	50	1.3	1.5	5.0	50
PR1502GS	100	150	1.5	55	50	1.3	1.5	5.0	100
PR1503GS	200	150	1.5	55	50	1.3	1.5	5.0	200
PR1504GS	400	150	1.5	55	50	1.3	1.5	5.0	400
PR1505GS	600	250	1.5	55	50	1.3	1.5	5.0	600
PR1506GS	800	500	1.5	55	50	1.3	1.5	5.0	800
PR1507GS	1000	500	1.5	55	50	1.3	1.5	5.0	1000

2.0A Fast Recovery Rectifiers / DO-15



PR2001	50	150	2.0	50	50	1.2	2.0	5.0	50
PR2002	100	150	2.0	50	50	1.2	2.0	5.0	100
PR2003	200	150	2.0	50	50	1.2	2.0	5.0	200
PR2004	400	150	2.0	50	50	1.2	2.0	5.0	400
PR2005	600	250	2.0	50	50	1.2	2.0	5.0	600

2.0A Fast Recovery Glass Passivated Rectifiers / DO-15



PR2001G	50	150	2.0	55	80	1.3	2.0	5.0	50
PR2002G	100	150	2.0	55	80	1.3	2.0	5.0	100
PR2003G	200	150	2.0	55	80	1.3	2.0	5.0	200
PR2004G	400	150	2.0	55	80	1.3	2.0	5.0	400
PR2005G	600	250	2.0	55	80	1.3	2.0	5.0	600
PR2006G	800	500	2.0	55	80	1.3	2.0	5.0	800
PR2007G	1000	500	2.0	55	80	1.3	2.0	5.0	1000

3.0A Fast Recovery Glass Passivated Rectifiers / SMB



RS3AB	50	150	3.0	75*	100	1.3	3.0	5.0	50
RS3BB	100	150	3.0	75*	100	1.3	3.0	5.0	100
RS3DB	200	150	3.0	75*	100	1.3	3.0	5.0	200
RS3GB	400	150	3.0	75*	100	1.3	3.0	5.0	400
RS3JB	600	250	3.0	75*	100	1.3	3.0	5.0	600
RS3KB	800	500	3.0	75*	100	1.3	3.0	5.0	800
RS3MB	1000	500	3.0	75*	100	1.3	3.0	5.0	1000

* T_T , Terminal Temperature

(†) Reference product datasheet for specific test conditions.

Type Number	Peak Repetitive Reverse Voltage	Reverse Recovery Time (t)	Max. Average Rectified Current		Max. Peak Forward Surge Current	Forward Voltage Drop		Max. Reverse Current	
	V _{RRM}	t _{rr}	I _O @ T _A		I _{FSM}	V _F @ I _F		I _R @ V _R	
	V	ns	A	°C	A	V	A	μA	V

3.0A Fast Recovery Glass Passivated Rectifiers / SMC



RS3A	50	150	3.0	75*	100	1.3	3.0	5.0	50
RS3B	100	150	3.0	75*	100	1.3	3.0	5.0	100
RS3D	200	150	3.0	75*	100	1.3	3.0	5.0	200
RS3G	400	150	3.0	75*	100	1.3	3.0	5.0	400
RS3J	600	250	3.0	75*	100	1.3	3.0	5.0	600
RS3K	800	500	3.0	75*	100	1.3	3.0	5.0	800
RS3M	1000	500	3.0	75*	100	1.3	3.0	5.0	1000

* T_T, Terminal Temperature

3.0A Fast Recovery Rectifiers / DO-201AD



PR3001	50	150	3.0	90	150	1.2	3.0	5.0	50
PR3002	100	150	3.0	90	150	1.2	3.0	5.0	100
PR3003	200	150	3.0	90	150	1.2	3.0	5.0	200
PR3004	400	150	3.0	90	150	1.2	3.0	5.0	400
PR3005	600	250	3.0	90	150	1.2	3.0	5.0	600

3.0A Fast Recovery Glass Passivated Rectifiers / DO-201AD



PR3001G	50	150	3.0	55	125	1.3	3.0	5.0	50
PR3002G	100	150	3.0	55	125	1.3	3.0	5.0	100
PR3003G	200	150	3.0	55	125	1.3	3.0	5.0	200
PR3004G	400	250	3.0	55	125	1.3	3.0	5.0	400
PR3005G	600	250	3.0	55	125	1.3	3.0	5.0	600
PR3006G	800	500	3.0	55	125	1.3	3.0	5.0	800
PR3007G	1000	500	3.0	55	125	1.3	3.0	5.0	1000



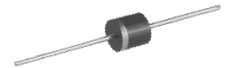

6.0A Fast Recovery Rectifiers / R-6



PR6001	50	150	6.0	60	300	1.2	6.0	10	50
PR6002	100	150	6.0	60	300	1.2	6.0	10	100
PR6003	200	150	6.0	60	300	1.2	6.0	10	200
PR6004	400	150	6.0	60	300	1.2	6.0	10	400
PR6005	600	250	6.0	60	300	1.2	6.0	10	600

(t) Reference product datasheet for specific test conditions.

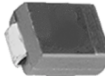
Standard Recovery Rectifiers

Type Number	Peak Repetitive Reverse Voltage	Max. Average Rectified Current (†)		Max. Peak Forward Surge Current (†)	Forward Voltage Drop		Max. Reverse Current (†)	
	V_{RRM}	$I_O @ T_T$		I_{FSM}	$V_F @ I_F$		$I_R @ V_R$	
	V	A	°C	A	V	A	µA	V
1.0A Standard Recovery Glass Passivated Rectifiers / MELF 								
DL4001	50	1.0	75	30	1.1	1.0	5.0	50
DL4002	100	1.0	75	30	1.1	1.0	5.0	100
DL4003	200	1.0	75	30	1.1	1.0	5.0	200
DL4004	400	1.0	75	30	1.1	1.0	5.0	400
DL4005	600	1.0	75	30	1.1	1.0	5.0	600
DL4006	800	1.0	75	30	1.1	1.0	5.0	800
DL4007	1000	1.0	75	30	1.1	1.0	5.0	1000
1.0A Standard Recovery Glass Passivated Rectifiers / SMA 								
S1A	50	1.0	100	30	1.1	1.0	5.0	50
S1B	100	1.0	100	30	1.1	1.0	5.0	100
S1D	200	1.0	100	30	1.1	1.0	5.0	200
S1G	400	1.0	100	30	1.1	1.0	5.0	400
S1J	600	1.0	100	30	1.1	1.0	5.0	600
S1K	800	1.0	100	30	1.1	1.0	5.0	800
S1M	1000	1.0	100	30	1.1	1.0	5.0	1000
1.0A Standard Recovery Glass Passivated Rectifiers / SMB 								
S1AB	50	1.0	100	30	1.1	1.0	5.0	50
S1BB	100	1.0	100	30	1.1	1.0	5.0	100
S1DB	200	1.0	100	30	1.1	1.0	5.0	200
S1GB	400	1.0	100	30	1.1	1.0	5.0	400
S1JB	600	1.0	100	30	1.1	1.0	5.0	600
S1KB	800	1.0	100	30	1.1	1.0	5.0	800
S1MB	1000	1.0	100	30	1.1	1.0	5.0	1000
1.0A Standard Recovery Glass Passivated Rectifiers / T-1 								
D1G	50	1.0	75*	30	1.0	1.0	5.0	50
D2G	100	1.0	75*	30	1.0	1.0	5.0	100
D3G	200	1.0	75*	30	1.0	1.0	5.0	200
D4G	400	1.0	75*	30	1.0	1.0	5.0	400
D5G	600	1.0	75*	30	1.0	1.0	5.0	600
D6G	800	1.0	75*	30	1.0	1.0	5.0	800
D7G	1000	1.0	75*	30	1.0	1.0	5.0	1000

* T_A , Ambient Temperature

(†) Reference product datasheet for specific test conditions.

Type Number	Peak Repetitive Reverse Voltage	Max. Average Rectified Current (†)		Max. Peak Forward Surge Current (†)	Forward Voltage Drop		Max. Reverse Current (†)	
	V_{RRM}	$I_O @ T_A$		I_{FSM}	$V_F @ I_F$		$I_R @ V_R$	
	V	A	°C	A	V	A	µA	V

1.0A Standard Recovery Rectifiers / DO-41



1N4001	50	1.0	75	30	1.0	1.0	5.0	50
1N4002	100	1.0	75	30	1.0	1.0	5.0	100
1N4003	200	1.0	75	30	1.0	1.0	5.0	200
1N4004	400	1.0	75	30	1.0	1.0	5.0	400
1N4005	600	1.0	75	30	1.0	1.0	5.0	600
1N4006	800	1.0	75	30	1.0	1.0	5.0	800
1N4007	1000	1.0	75	30	1.0	1.0	5.0	1000

1.0A Standard Recovery Glass Passivated Rectifiers / DO-41



1N4001G	50	1.0	75	30	1.0	1.0	5.0	50
1N4002G	100	1.0	75	30	1.0	1.0	5.0	100
1N4003G	200	1.0	75	30	1.0	1.0	5.0	200
1N4004G	400	1.0	75	30	1.0	1.0	5.0	400
1N4005G	600	1.0	75	30	1.0	1.0	5.0	600
1N4006G	800	1.0	75	30	1.0	1.0	5.0	800
1N4007G	1000	1.0	75	30	1.0	1.0	5.0	1000

1.0A Standard Recovery Rectifiers / A-405



1N4001L	50	1.0	75	30	1.0	1.0	5.0	50
1N4002L	100	1.0	75	30	1.0	1.0	5.0	100
1N4003L	200	1.0	75	30	1.0	1.0	5.0	200
1N4004L	400	1.0	75	30	1.0	1.0	5.0	400
1N4005L	600	1.0	75	30	1.0	1.0	5.0	600
1N4006L	800	1.0	75	30	1.0	1.0	5.0	800
1N4007L	1000	1.0	75	30	1.0	1.0	5.0	1000

1.0A Standard Recovery Glass Passivated Rectifiers / A-405



1N4001GL	50	1.0	75	30	1.0	1.0	5.0	50
1N4002GL	100	1.0	75	30	1.0	1.0	5.0	100
1N4003GL	200	1.0	75	30	1.0	1.0	5.0	200
1N4004GL	400	1.0	75	30	1.0	1.0	5.0	400
1N4005GL	600	1.0	75	30	1.0	1.0	5.0	600
1N4006GL	800	1.0	75	30	1.0	1.0	5.0	800
1N4007GL	1000	1.0	75	30	1.0	1.0	5.0	1000

1.5A Standard Recovery Glass Passivated Rectifiers / SMA



S2AA	50	1.5	100*	50	1.15	1.5	5.0	50
S2BA	100	1.5	100*	50	1.15	1.5	5.0	100
S2DA	200	1.5	100*	50	1.15	1.5	5.0	200
S2GA	400	1.5	100*	50	1.15	1.5	5.0	400
S2JA	600	1.5	100*	50	1.15	1.5	5.0	600
S2KA	800	1.5	100*	50	1.15	1.5	5.0	800
S2MA	1000	1.5	100*	50	1.15	1.5	5.0	1000

* T_T , Terminal Temperature

(†) Reference product datasheet for specific test conditions.

Type Number	Peak Repetitive Reverse Voltage	Max. Average Rectified Current (†)		Max. Peak Forward Surge Current (†)	Forward Voltage Drop		Max. Reverse Current (†)	
	V_{RRM}	$I_O @ T_A$		I_{FSM}	$V_F @ I_F$		$I_R @ V_R$	
	V	A	°C	A	V	A	µA	V

1.5A Standard Recovery Glass Passivated Rectifiers / SMB



S2A	50	1.5	100*	50	1.15	1.5	5.0	50
S2B	100	1.5	100*	50	1.15	1.5	5.0	100
S2D	200	1.5	100*	50	1.15	1.5	5.0	200
S2G	400	1.5	100*	50	1.15	1.5	5.0	400
S2J	600	1.5	100*	50	1.15	1.5	5.0	600
S2K	800	1.5	100*	50	1.15	1.5	5.0	800
S2M	1000	1.5	100*	50	1.15	1.5	5.0	1000

* T_T , Terminal Temperature

1.5A Standard Recovery Rectifiers / DO-15



1N5391	50	1.5	70	50	1.1	1.5	5.0	50
1N5392	100	1.5	70	50	1.1	1.5	5.0	100
1N5393	200	1.5	70	50	1.1	1.5	5.0	200
1N5395	400	1.5	70	50	1.1	1.5	5.0	400
1N5397	600	1.5	70	50	1.1	1.5	5.0	600
1N5398	800	1.5	70	50	1.1	1.5	5.0	800
1N5399	1000	1.5	70	50	1.1	1.5	5.0	1000

1.5A Standard Recovery Glass Passivated Rectifiers / DO-15



LT1501G	50	1.5	55	50	1.1	1.5	5.0	50
LT1502G	100	1.5	55	50	1.1	1.5	5.0	100
LT1503G	200	1.5	55	50	1.1	1.5	5.0	200
LT1504G	400	1.5	55	50	1.1	1.5	5.0	400
LT1505G	600	1.5	55	50	1.1	1.5	5.0	600
LT1506G	800	1.5	55	50	1.1	1.5	5.0	800
LT1507G	1000	1.5	55	50	1.1	1.5	5.0	1000

1.5A Standard Recovery Rectifiers / DO-41



1N5391S	50	1.5	70	50	1.1	1.5	5.0	50
1N5392S	100	1.5	70	50	1.1	1.5	5.0	100
1N5393S	200	1.5	70	50	1.1	1.5	5.0	200
1N5395S	400	1.5	70	50	1.1	1.5	5.0	400
1N5397S	600	1.5	70	50	1.1	1.5	5.0	600
1N5398S	800	1.5	70	50	1.1	1.5	5.0	800
1N5399S	1000	1.5	70	50	1.1	1.5	5.0	1000

(†) Reference product datasheet for specific test conditions.

Type Number	Peak Repetitive Reverse Voltage	Max. Average Rectified Current (†)		Max. Peak Forward Surge Current (†)	Forward Voltage Drop		Max. Reverse Current (†)	
	V_{RRM}	$I_O @ T_T$		I_{FSM}	$V_F @ I_F$		$I_R @ V_R$	
	V	A	°C	A	V	A	µA	V

2.0A Standard Recovery Rectifiers / DO-15



LT2A01	50	2.0	55*	70	1.1	2.0	5.0	50
LT2A02	100	2.0	55*	70	1.1	2.0	5.0	100
LT2A03	200	2.0	55*	70	1.1	2.0	5.0	200
LT2A04	400	2.0	55*	70	1.1	2.0	5.0	400
LT2A05	600	2.0	55*	70	1.1	2.0	5.0	600
LT2A06	800	2.0	55*	70	1.1	2.0	5.0	800
LT2A07	1000	2.0	55*	70	1.1	2.0	5.0	1000

2.0A Standard Recovery Glass Passivated Rectifiers / DO-15



LT2A01G	50	2.0	55*	65	1.1	2.0	5.0	50
LT2A02G	100	2.0	55*	65	1.1	2.0	5.0	100
LT2A03G	200	2.0	55*	65	1.1	2.0	5.0	200
LT2A04G	400	2.0	55*	65	1.1	2.0	5.0	400
LT2A05G	600	2.0	55*	65	1.1	2.0	5.0	600
LT2A06G	800	2.0	55*	65	1.1	2.0	5.0	800
LT2A07G	1000	2.0	55*	65	1.1	2.0	5.0	1000

* T_T , Terminal Temperature

3.0A Standard Recovery Glass Passivated Rectifiers / SMB



S3AB	50	3.0	75	100	1.15	3.0	10	50
S3BB	100	3.0	75	100	1.15	3.0	10	100
S3DB	200	3.0	75	100	1.15	3.0	10	200
S3GB	400	3.0	75	100	1.15	3.0	10	400
S3JB	600	3.0	75	100	1.15	3.0	10	600
S3KB	800	3.0	75	100	1.15	3.0	10	800
S3MB	1000	3.0	75	100	1.15	3.0	10	1000

3.0A Standard Recovery Glass Passivated Rectifiers / SMC



S3A	50	3.0	75	100	1.15	3.0	10	50
S3B	100	3.0	75	100	1.15	3.0	10	100
S3D	200	3.0	75	100	1.15	3.0	10	200
S3G	400	3.0	75	100	1.15	3.0	10	400
S3J	600	3.0	75	100	1.15	3.0	10	600
S3K	800	3.0	75	100	1.15	3.0	10	800
S3M	1000	3.0	75	100	1.15	3.0	10	1000

(†) Reference product datasheet for specific test conditions.

Type Number	Peak Repetitive Reverse Voltage	Max. Average Rectified Current (†)		Max. Peak Forward Surge Current (†)	Forward Voltage Drop		Max. Reverse Current (†)	
	V_{RRM}	$I_O @ T_A$		I_{FSM}	$V_F @ I_F$		$I_R @ V_R$	
	V	A	°C	A	V	A	µA	V

3.0A Standard Recovery Rectifiers / DO-201AD



1N5400	50	3.0	105	200	1.0	3.0	10	50
1N5401	100	3.0	105	200	1.0	3.0	10	100
1N5402	200	3.0	105	200	1.0	3.0	10	200
1N5404	400	3.0	105	200	1.0	3.0	10	400
1N5406	600	3.0	105	200	1.0	3.0	10	600
1N5407	800	3.0	105	200	1.0	3.0	10	800
1N5408	1000	3.0	105	200	1.0	3.0	10	1000

3.0A Standard Recovery Glass Passivated Rectifiers / DO-201AD



1N5400G	50	3.0	55	125	1.1	3.0	5.0	50
1N5401G	100	3.0	55	125	1.1	3.0	5.0	100
1N5402G	200	3.0	55	125	1.1	3.0	5.0	200
1N5403G	300	3.0	55	125	1.1	3.0	5.0	300
1N5404G	400	3.0	55	125	1.1	3.0	5.0	400
1N5405G	500	3.0	55	125	1.1	3.0	5.0	500
1N5406G	600	3.0	55	125	1.1	3.0	5.0	600
1N5407G	800	3.0	55	125	1.1	3.0	5.0	800
1N5408G	1000	3.0	55	125	1.1	3.0	5.0	1000

5.0A Standard Recovery Glass Passivated Rectifiers / SMC



S5AC	50	5.0	75*	100	1.15	5.0	10	50
S5BC	100	5.0	75*	100	1.15	5.0	10	100
S5DC	200	5.0	75*	100	1.15	5.0	10	200
S5GC	400	5.0	75*	100	1.15	5.0	10	400
S5JC	600	5.0	75*	100	1.15	5.0	10	600
S5KC	800	5.0	75*	100	1.15	5.0	10	800
S5MC	1000	5.0	75*	100	1.15	5.0	10	1000

* T_T , Terminal Temperature

6.0A/10A Standard Recovery Rectifiers / R-6



LT6A01	50	6.0	60	400	1.0	6.0	10	50
LT6A02	100	6.0	60	400	1.0	6.0	10	100
LT6A03	200	6.0	60	400	1.0	6.0	10	200
LT6A04	400	6.0	60	400	1.0	6.0	10	400
LT6A05	600	6.0	60	400	1.0	6.0	10	600
LT6A06	800	6.0	60	400	1.0	6.0	10	800
LT6A07	1000	6.0	60	400	1.0	6.0	10	1000
LT10A01	50	10	50	600	1.0	10	10	50
LT10A02	100	10	50	600	1.0	10	10	100
LT10A03	200	10	50	600	1.0	10	10	200
LT10A04	400	10	50	600	1.0	10	10	400
LT10A05	600	10	50	600	1.0	10	10	600
LT10A06	800	10	50	600	1.0	10	10	800
LT10A07	1000	10	50	600	1.0	10	10	1000

(†) Reference product datasheet for specific test conditions.

Bridge Rectifiers

Type Number	Peak Repetitive Reverse Voltage	Max. Average Rectified Current (†)		Max. Peak Forward Surge Current (†)	Forward Voltage Drop		Max. Reverse Current (†)		
	V_{RRM}	$I_O @ T_A$		I_{FSM}	$V_F @ I_F$		$I_R @ V_R$		
	V	A	°C	A	V	A	µA	V	
0.8A Glass Passivated Bridge Rectifiers / HD MiniDIP									
HD01	100	0.8	40	30	1.0	0.4	5.0	100	
HD02	200	0.8	40	30	1.0	0.4	5.0	200	
HD04	400	0.8	40	30	1.0	0.4	5.0	400	
HD06	600	0.8	40	30	1.0	0.4	5.0	600	
1.0A Glass Passivated Bridge Rectifiers / DF-S									
DF005S	50	1.0	40	50	1.1	1.0	10	50	
DF01S	100	1.0	40	50	1.1	1.0	10	100	
DF02S	200	1.0	40	50	1.1	1.0	10	200	
DF04S	400	1.0	40	50	1.1	1.0	10	400	
DF06S	600	1.0	40	50	1.1	1.0	10	600	
DF08S	800	1.0	40	50	1.1	1.0	10	800	
DF10S	1000	1.0	40	50	1.1	1.0	10	1000	
1.0A Glass Passivated Bridge Rectifiers / DF-M									
DF005M	50	1.0	40	50	1.1	1.0	10	50	
DF01M	100	1.0	40	50	1.1	1.0	10	100	
DF02M	200	1.0	40	50	1.1	1.0	10	200	
DF04M	400	1.0	40	50	1.1	1.0	10	400	
DF06M	600	1.0	40	50	1.1	1.0	10	600	
DF08M	800	1.0	40	50	1.1	1.0	10	800	
DF10M	1000	1.0	40	50	1.1	1.0	10	1000	
1.5A Glass Passivated Bridge Rectifiers / DF-S									
DF15005S	50	1.5	40	50	1.1	1.5	10	50	
DF1501S	100	1.5	40	50	1.1	1.5	10	100	
DF1502S	200	1.5	40	50	1.1	1.5	10	200	
DF1504S	400	1.5	40	50	1.1	1.5	10	400	
DF1506S	600	1.5	40	50	1.1	1.5	10	600	
DF1508S	800	1.5	40	50	1.1	1.5	10	800	
DF1510S	1000	1.5	40	50	1.1	1.5	10	1000	
1.5A Glass Passivated Bridge Rectifiers / DF-M									
DF15005M	50	1.5	40	50	1.1	1.5	10	50	
DF1501M	100	1.5	40	50	1.1	1.5	10	100	
DF1502M	200	1.5	40	50	1.1	1.5	10	200	
DF1504M	400	1.5	40	50	1.1	1.5	10	400	
DF1506M	600	1.5	40	50	1.1	1.5	10	600	
DF1508M	800	1.5	40	50	1.1	1.5	10	800	
DF1510M	1000	1.5	40	50	1.1	1.5	10	1000	

(†) Reference product datasheet for specific test conditions.

Type Number	Peak Repetitive Reverse Voltage	Max. Average Rectified Current (†)		Max. Peak Forward Surge Current (†)	Forward Voltage Drop		Max. Reverse Current (†)	
	V_{RRM}	$I_O @ T_A$		I_{FSM}	$V_F @ I_F$		$I_R @ V_R$	
	V	A	°C	A	V	A	µA	V

1.5A Glass Passivated Bridge Rectifiers / WOG



W005G	50	1.5	25*	50	1.0	1.5	5.0	50
W01G	100	1.5	25*	50	1.0	1.5	5.0	100
W02G	200	1.5	25*	50	1.0	1.5	5.0	200
W04G	400	1.5	25*	50	1.0	1.5	5.0	400
W06G	600	1.5	25*	50	1.0	1.5	5.0	600
W08G	800	1.5	25*	50	1.0	1.5	5.0	800
W10G	1000	1.5	25*	50	1.0	1.5	5.0	1000

* TA, Ambient temperature

1.5A Glass Passivated Bridge Rectifiers / KBP



KBP005G	50	1.5	105	40	1.1	1.5	5.0	50
KBP01G	100	1.5	105	40	1.1	1.5	5.0	100
KBP02G	200	1.5	105	40	1.1	1.5	5.0	200
KBP04G	400	1.5	105	40	1.1	1.5	5.0	400
KBP06G	600	1.5	105	40	1.1	1.5	5.0	600
KBP08G	800	1.5	105	40	1.1	1.5	5.0	800
KBP10G	1000	1.5	105	40	1.1	1.5	5.0	1000

2.0A Glass Passivated Bridge Rectifiers / WOG



2W005G	50	2.0	25*	60	1.1	2.0	5.0	50
2W01G	100	2.0	25*	60	1.1	2.0	5.0	100
2W02G	200	2.0	25*	60	1.1	2.0	5.0	200
2W04G	400	2.0	25*	60	1.1	2.0	5.0	400
2W06G	600	2.0	25*	60	1.1	2.0	5.0	600
2W08G	800	2.0	25*	60	1.1	2.0	5.0	800
2W10G	1000	2.0	25*	60	1.1	2.0	5.0	1000





* TA, Ambient temperature

2.0A Glass Passivated Bridge Rectifiers / KBP



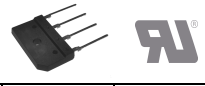

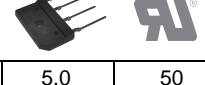









KBP2005G	50	2.0	105	65	1.1	2.0	5.0	50
KBP201G	100	2.0	105	65	1.1	2.0	5.0	100
KBP202G	200	2.0	105	65	1.1	2.0	5.0	200
KBP204G	400	2.0	105	65	1.1	2.0	5.0	400
KBP206G	600	2.0	105	65	1.1	2.0	5.0	600
KBP208G	800	2.0	105	65	1.1	2.0	5.0	800
KBP210G	1000	2.0	105	65	1.1	2.0	5.0	1000



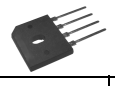







(†) Reference product datasheet for specific test conditions.

Type Number	Peak Repetitive Reverse Voltage	Max. Average Rectified Current (†)		Max. Peak Forward Surge Current (†)	Forward Voltage Drop		Max. Reverse Current (†)	
	V _{RRM}	I _O @ T _A		I _{FSM}	V _F @ I _F		I _R @ V _R	
	V	A	°C	A	V	A	µA	V
3.0A Bridge Rectifiers / PBPC-3 								
PBPC301	50	3.0	50	50	1.2	1.5	10	50
PBPC302	100	3.0	50	50	1.2	1.5	10	100
PBPC303	200	3.0	50	50	1.2	1.5	10	200
PBPC304	400	3.0	50	50	1.2	1.5	10	400
PBPC305	600	3.0	50	50	1.2	1.5	10	600
PBPC306	800	3.0	50	50	1.2	1.5	10	800
PBPC307	1000	3.0	50	50	1.2	1.5	10	1000
4.0A Glass Passivated Bridge Rectifiers / KBJ 								
KBJ4005G	50	4.0	115	120	1.0	2.0	5.0	50
KBJ401G	100	4.0	115	120	1.0	2.0	5.0	100
KBJ402G	200	4.0	115	120	1.0	2.0	5.0	200
KBJ404G	400	4.0	115	120	1.0	2.0	5.0	400
KBJ406G	600	4.0	115	120	1.0	2.0	5.0	600
KBJ408G	800	4.0	115	120	1.0	2.0	5.0	800
KBJ410G	1000	4.0	115	120	1.0	2.0	5.0	1000
4.0A Glass Passivated Bridge Rectifiers / GBU NEW 								
GBU4005	50	4.0	100	150	1.0	2.0	5.0	50
GBU401	100	4.0	100	150	1.0	2.0	5.0	100
GBU402	200	4.0	100	150	1.0	2.0	5.0	200
GBU404	400	4.0	100	150	1.0	2.0	5.0	400
GBU406	600	4.0	100	150	1.0	2.0	5.0	600
GBU408	800	4.0	100	150	1.0	2.0	5.0	800
GBU410	1000	4.0	100	150	1.0	2.0	5.0	1000
6.0A Glass Passivated Bridge Rectifiers / KBJ 								
KBJ6005G	50	6.0	110	170	1.0	3.0	5.0	50
KBJ601G	100	6.0	110	170	1.0	3.0	5.0	100
KBJ602G	200	6.0	110	170	1.0	3.0	5.0	200
KBJ604G	400	6.0	110	170	1.0	3.0	5.0	400
KBJ606G	600	6.0	110	170	1.0	3.0	5.0	600
KBJ608G	800	6.0	110	170	1.0	3.0	5.0	800
KBJ610G	1000	6.0	110	170	1.0	3.0	5.0	1000
6.0A Glass Passivated Bridge Rectifiers / GBJ 								
GBJ6005	50	6.0	110	170	1.0	3.0	5.0	50
GBJ601	100	6.0	110	170	1.0	3.0	5.0	100
GBJ602	200	6.0	110	170	1.0	3.0	5.0	200
GBJ604	400	6.0	110	170	1.0	3.0	5.0	400
GBJ606	600	6.0	110	170	1.0	3.0	5.0	600
GBJ608	800	6.0	110	170	1.0	3.0	5.0	800
GBJ610	1000	6.0	110	170	1.0	3.0	5.0	1000

(†) Reference product datasheet for specific test conditions.

Type Number	Peak Repetitive Reverse Voltage	Max. Average Rectified Current (†)		Max. Peak Forward Surge Current (†)	Forward Voltage Drop		Max. Reverse Current (†)		
	V_{RRM}	$I_O @ T_A$		I_{FSM}	$V_F @ I_F$		$I_R @ V_R$		
	V	A	°C	A	V	A	µA	V	
6.0A Glass Passivated Bridge Rectifiers / GBU   									
GBU6005	50	6.0	100	175	1.0	3.0	5.0	50	
GBU601	100	6.0	100	175	1.0	3.0	5.0	100	
GBU602	200	6.0	100	175	1.0	3.0	5.0	200	
GBU604	400	6.0	100	175	1.0	3.0	5.0	400	
GBU606	600	6.0	100	175	1.0	3.0	5.0	600	
GBU608	800	6.0	100	175	1.0	3.0	5.0	800	
GBU610	1000	6.0	100	175	1.0	3.0	5.0	1000	
6.0A Bridge Rectifiers / PBPC-3  									
PBPC601	50	6.0	50	125	1.1	3.0	10	50	
PBPC602	100	6.0	50	125	1.1	3.0	10	100	
PBPC603	200	6.0	50	125	1.1	3.0	10	200	
PBPC604	400	6.0	50	125	1.1	3.0	10	400	
PBPC605	600	6.0	50	125	1.1	3.0	10	600	
PBPC606	800	6.0	50	125	1.1	3.0	10	800	
PBPC607	1000	6.0	50	125	1.1	3.0	10	1000	
8.0A Glass Passivated Bridge Rectifiers / GBJ  									
GBJ8005	50	8.0	110	170	1.0	4.0	5.0	50	
GBJ801	100	8.0	110	170	1.0	4.0	5.0	100	
GBJ802	200	8.0	110	170	1.0	4.0	5.0	200	
GBJ804	400	8.0	110	170	1.0	4.0	5.0	400	
GBJ806	600	8.0	110	170	1.0	4.0	5.0	600	
GBJ808	800	8.0	110	170	1.0	4.0	5.0	800	
GBJ810	1000	8.0	110	170	1.0	4.0	5.0	1000	
8.0A Glass Passivated Bridge Rectifiers / GBU   									
GBU8005	50	8.0	100	200	1.0	4.0	5.0	50	
GBU801	100	8.0	100	200	1.0	4.0	5.0	100	
GBU802	200	8.0	100	200	1.0	4.0	5.0	200	
GBU804	400	8.0	100	200	1.0	4.0	5.0	400	
GBU806	600	8.0	100	200	1.0	4.0	5.0	600	
GBU808	800	8.0	100	200	1.0	4.0	5.0	800	
GBU810	1000	8.0	100	200	1.0	4.0	5.0	1000	
8.0A Bridge Rectifiers / PBPC-8  									
PBPC801	50	8.0	50	125	1.1	4.0	10	50	
PBPC802	100	8.0	50	125	1.1	4.0	10	100	
PBPC803	200	8.0	50	125	1.1	4.0	10	200	
PBPC804	400	8.0	50	125	1.1	4.0	10	400	
PBPC805	600	8.0	50	125	1.1	4.0	10	600	
PBPC806	800	8.0	50	125	1.1	4.0	10	800	
PBPC807	1000	8.0	50	125	1.1	4.0	10	1000	





(†) Reference product datasheet for specific test conditions.

Type Number	Peak Repetitive Reverse Voltage	Max. Average Rectified Current (†)		Max. Peak Forward Surge Current (†)	Forward Voltage Drop		Max. Reverse Current (†)	
	V_{RRM}	$I_O @ T_A$		I_{FSM}	$V_F @ I_F$		$I_R @ V_R$	
	V	A	°C	A	V	A	µA	V
10A Glass Passivated Bridge Rectifiers / GBJ  								
GBJ10005	50	10	110	170	1.05	5.0	10	50
GBJ1001	100	10	110	170	1.05	5.0	10	100
GBJ1002	200	10	110	170	1.05	5.0	10	200
GBJ1004	400	10	110	170	1.05	5.0	10	400
GBJ1006	600	10	110	170	1.05	5.0	10	600
GBJ1008	800	10	110	170	1.05	5.0	10	800
GBJ1010	1000	10	110	170	1.05	5.0	10	1000
10A Glass Passivated Bridge Rectifiers / GBU   NEW								
GBU10005	50	10	100	220	1.0	5.0	5.0	50
GBU1001	100	10	100	220	1.0	5.0	5.0	100
GBU1002	200	10	100	220	1.0	5.0	5.0	200
GBU1004	400	10	100	220	1.0	5.0	5.0	400
GBU1006	600	10	100	220	1.0	5.0	5.0	600
GBU1008	800	10	100	220	1.0	5.0	5.0	800
GBU1010	1000	10	100	220	1.0	5.0	5.0	1000
10A Bridge Rectifiers / PBPC-8  								
PBPC1001	50	10	110	170	1.0	4.0	5.0	50
PBPC1002	100	10	110	170	1.0	4.0	5.0	100
PBPC1003	200	10	110	170	1.0	4.0	5.0	200
PBPC1004	400	10	110	170	1.0	4.0	5.0	400
PBPC1005	600	10	110	170	1.0	4.0	5.0	600
PBPC1006	800	10	110	170	1.0	4.0	5.0	800
PBPC1007	1000	10	110	170	1.0	4.0	5.0	1000
15A Glass Passivated Bridge Rectifiers / GBJ  								
GBJ15005	50	15	100	240	1.05	7.5	10	50
GBJ1501	100	15	100	240	1.05	7.5	10	100
GBJ1502	200	15	100	240	1.05	7.5	10	200
GBJ1504	400	15	100	240	1.05	7.5	10	400
GBJ1506	600	15	100	240	1.05	7.5	10	600
GBJ1508	800	15	100	240	1.05	7.5	10	800
GBJ1510	1000	15	100	240	1.05	7.5	10	1000
15A Glass Passivated Bridge Rectifiers / GBPC  								
GBPC15005	50	15	70	300	1.1	7.5	5.0	50
GBPC1501	100	15	70	300	1.1	7.5	5.0	100
GBPC1502	200	15	70	300	1.1	7.5	5.0	200
GBPC1504	400	15	70	300	1.1	7.5	5.0	400
GBPC1506	600	15	70	300	1.1	7.5	5.0	600
GBPC1508	800	15	70	300	1.1	7.5	5.0	800
GBPC1510	1000	15	70	300	1.1	7.5	5.0	1000

(†) Reference product datasheet for specific test conditions.

Type Number	Peak Repetitive Reverse Voltage	Max. Average Rectified Current (†)		Max. Peak Forward Surge Current (†)	Forward Voltage Drop		Max. Reverse Current (†)		
	V_{RRM}	$I_O @ T_A$		I_{FSM}	$V_F @ I_F$		$I_R @ V_R$		
	V	A	°C	A	V	A	µA	V	
15A Glass Passivated Bridge Rectifiers / GBPC-W									
GBPC15005W	50	15	70	300	1.1	7.5	5.0	50	
GBPC1501W	100	15	70	300	1.1	7.5	5.0	100	
GBPC1502W	200	15	70	300	1.1	7.5	5.0	200	
GBPC1504W	400	15	70	300	1.1	7.5	5.0	400	
GBPC1506W	600	15	70	300	1.1	7.5	5.0	600	
GBPC1508W	800	15	70	300	1.1	7.5	5.0	800	
GBPC1510W	1000	15	70	300	1.1	7.5	5.0	1000	
20A Glass Passivated Bridge Rectifiers / GBJ									
GBJ20005	50	20	110	240	1.05	10	10	50	
GBJ2001	100	20	110	240	1.05	10	10	100	
GBJ2002	200	20	110	240	1.05	10	10	200	
GBJ2004	400	20	110	240	1.05	10	10	400	
GBJ2006	600	20	110	240	1.05	10	10	600	
GBJ2008	800	20	110	240	1.05	10	10	800	
GBJ2010	1000	20	110	240	1.05	10	10	1000	
25A Glass Passivated Bridge Rectifiers / GBJ									
GBJ25005	50	25	100	350	1.05	12.5	10	50	
GBJ2501	100	25	100	350	1.05	12.5	10	100	
GBJ2502	200	25	100	350	1.05	12.5	10	200	
GBJ2504	400	25	100	350	1.05	12.5	10	400	
GBJ2506	600	25	100	350	1.05	12.5	10	600	
GBJ2508	800	25	100	350	1.05	12.5	10	800	
GBJ2510	1000	25	100	350	1.05	12.5	10	1000	
25A Glass Passivated Bridge Rectifiers / GBPC									
GBPC25005	50	25	60	300	1.1	12.5	5.0	50	
GBPC2501	100	25	60	300	1.1	12.5	5.0	100	
GBPC2502	200	25	60	300	1.1	12.5	5.0	200	
GBPC2504	400	25	60	300	1.1	12.5	5.0	400	
GBPC2506	600	25	60	300	1.1	12.5	5.0	600	
GBPC2508	800	25	60	300	1.1	12.5	5.0	800	
GBPC2510	1000	25	60	300	1.1	12.5	5.0	1000	
25A Glass Passivated Bridge Rectifiers / GBPC-W									
GBPC25005W	50	25	60	300	1.1	12.5	5.0	50	
GBPC2501W	100	25	60	300	1.1	12.5	5.0	100	
GBPC2502W	200	25	60	300	1.1	12.5	5.0	200	
GBPC2504W	400	25	60	300	1.1	12.5	5.0	400	
GBPC2506W	600	25	60	300	1.1	12.5	5.0	600	
GBPC2508W	800	25	60	300	1.1	12.5	5.0	800	
GBPC2510W	1000	25	60	300	1.1	12.5	5.0	1000	

(†) Reference product datasheet for specific test conditions.

Type Number	Peak Repetitive Reverse Voltage	Max. Average Rectified Current (†)		Max. Peak Forward Surge Current (†)	Forward Voltage Drop		Max. Reverse Current (†)	
	V_{RRM}	$I_O @ T_A$		I_{FSM}	$V_F @ I_F$		$I_R @ V_R$	
	V	A	°C	A	V	A	μA	V
35A Glass Passivated Bridge Rectifiers / GBPC								
GBPC35005	50	35	50	400	1.1	17.5	5.0	50
GBPC3501	100	35	50	400	1.1	17.5	5.0	100
GBPC3502	200	35	50	400	1.1	17.5	5.0	200
GBPC3504	400	35	50	400	1.1	17.5	5.0	400
GBPC3506	600	35	50	400	1.1	17.5	5.0	600
GBPC3508	800	35	50	400	1.1	17.5	5.0	800
GBPC3510	1000	35	50	400	1.1	17.5	5.0	1000
35A Glass Passivated Bridge Rectifiers / GBPC-W								
GBPC35005W	50	35	50	400	1.1	17.5	5.0	50
GBPC3501W	100	35	50	400	1.1	17.5	5.0	100
GBPC3502W	200	35	50	400	1.1	17.5	5.0	200
GBPC3504W	400	35	50	400	1.1	17.5	5.0	400
GBPC3506W	600	35	50	400	1.1	17.5	5.0	600
GBPC3508W	800	35	50	400	1.1	17.5	5.0	800
GBPC3510W	1000	35	50	400	1.1	17.5	5.0	1000

(†) Reference product datasheet for specific test conditions.

Zener Diodes

Type Number	Zener Voltage Range ¹		Max. Zener Impedance		Typical Temperature Coefficient	Min. Reverse Voltage
	V _Z @ I _{ZT} = 5.0mA		Z _{ZT} @ I _{ZT} = 5.0mA	Z _{ZK} @ I _{ZK} = 1.0mA	T _C	V _R @ I _R = 0.1μA
	Min V	Max V	Ω	Ω	% / °C	V

300mW Zener Diodes (DUAL Common Anode) / SOT-23

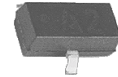

AZ23C2V7	2.5	2.9	83	500	-0.065	—
AZ23C3V0	2.8	3.2	95	500	-0.060	—
AZ23C3V3	3.1	3.5	95	500	-0.055	—
AZ23C3V6	3.4	3.8	95	500	-0.055	—
AZ23C3V9	3.7	4.1	95	500	-0.050	—
AZ23C4V3	4.0	4.6	95	500	-0.035	—
AZ23C4V7	4.4	5.0	78	500	-0.015	—
AZ23C5V1	4.8	5.4	60	480	+0.005	0.8
AZ23C5V6	5.2	6.0	40	400	+0.020	1.0
AZ23C6V2	5.8	6.6	10	200	+0.030	2.0
AZ23C6V8	6.4	7.2	8.0	150	+0.045	3.0
AZ23C7V5	7.0	7.9	7.0	50	+0.050	5.0
AZ23C8V2	7.7	8.7	7.0	50	+0.055	6.0
AZ23C9V1	8.5	9.6	10	50	+0.065	7.0
AZ23C10	9.4	10.6	15	70	+0.065	7.5
AZ23C11	10.4	11.6	20	70	+0.070	8.5
AZ23C12	11.4	12.7	20	90	+0.075	9.0
AZ23C13	12.4	14.1	25	110	+0.080	10.0
AZ23C15	13.8	15.6	30	110	+0.080	11.0
AZ23C16	15.3	17.1	40	170	+0.090	12.0
AZ23C18	16.8	19.1	50	170	+0.090	14.0
AZ23C20	18.8	21.2	50	220	+0.090	15.0
AZ23C22	20.8	23.3	55	220	+0.090	17.0
AZ23C24	22.8	25.6	80	220	+0.090	18.0
AZ23C27	25.1	28.9	80	250	+0.090	20.0
AZ23C30	28	32	80	250	+0.090	22.5
AZ23C33	31	35	80	250	+0.090	25.0
AZ23C36	34	38	90	250	+0.090	27.0
AZ23C39	37	41	90	300	+0.110	29.0
AZ23C43	40	46	100	700	+0.110	32.0
AZ23C47	44	50	100	750	+0.110	35.0
AZ23C51	48	54	100	750	+0.110	38.0

1. Tested with I_{ZT} current pulses. Pulse width = 5.0ms.

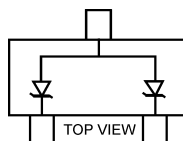

Pin Configuration

Type Number	Zener Voltage Range ¹		Max. Zener Impedance				Typical Temperature Coefficient	Max. Reverse Leakage Current	
	$V_Z @ I_{ZT}$		$Z_{ZT} @ I_{ZT}$		$Z_{ZK} @ I_{ZK}$		T_C	$I_R @ V_R$	
	Min V	Max V	Ω	mA	Ω	mA	% / °C	μA	V

350mW Zener Diodes (Single) / SOT-23

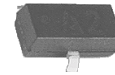

BZX84C2V7*	2.5	2.9	100	5.0	600	1.0	-0.065	20	1.0
BZX84C3V0	2.8	3.2	100	5.0	600	1.0	-0.060	10	1.0
BZX84C3V3*	3.1	3.5	95	5.0	600	1.0	-0.055	5.0	1.0
BZX84C3V6	3.4	3.8	95	5.0	600	1.0	-0.055	5.0	1.0
BZX84C3V9*	3.7	4.1	90	5.0	600	1.0	-0.050	3.0	1.0
BZX84C4V3*	4.0	4.6	90	5.0	600	1.0	-0.035	3.0	1.0
BZX84C4V7*	4.4	5.0	80	5.0	500	1.0	-0.015	4.0	2.0
BZX84C5V1*	4.8	5.4	60	5.0	480	1.0	+0.005	2.0	2.0
BZX84C5V6*	5.2	6.0	40	5.0	400	1.0	+0.020	1.0	2.0
BZX84C6V2*	5.8	6.6	10	5.0	150	1.0	+0.030	3.0	4.0
BZX84C6V8*	6.4	7.2	15	5.0	80	1.0	+0.045	2.0	4.0
BZX84C7V5*	7.0	7.9	15	5.0	80	1.0	+0.050	1.0	5.0
BZX84C8V2*	7.7	8.7	15	5.0	80	1.0	+0.055	0.7	5.0
BZX84C9V1	8.5	9.6	15	5.0	100	1.0	+0.065	0.5	6.0
BZX84C10*	9.4	10.6	20	5.0	150	1.0	+0.065	0.2	7.0
BZX84C11	10.4	11.6	20	5.0	150	1.0	+0.070	0.1	8.0
BZX84C12*	11.4	12.7	25	5.0	150	1.0	+0.075	0.1	8.0
BZX84C13*	12.4	14.1	30	5.0	170	1.0	+0.080	0.1	8.0
BZX84C15*	13.8	15.6	30	5.0	200	1.0	+0.080	0.05	0.7V _{Znom}
BZX84C16	15.3	17.1	40	5.0	200	1.0	+0.090	0.05	0.7V _{Znom}
BZX84C18*	16.8	19.1	45	5.0	225	1.0	+0.090	0.05	0.7V _{Znom}
BZX84C20*	18.8	21.2	55	5.0	225	1.0	+0.090	0.05	0.7V _{Znom}
BZX84C22	20.8	23.3	55	5.0	250	1.0	+0.090	0.05	0.7V _{Znom}
BZX84C24*	22.8	25.6	70	5.0	250	1.0	+0.090	0.05	0.7V _{Znom}
BZX84C27*	25.1	28.9	80	2.0	300	0.5	+0.090	0.05	0.7V _{Znom}
BZX84C30	28	32	80	2.0	300	0.5	+0.090	0.05	0.7V _{Znom}
BZX84C33*	31	35	80	2.0	325	0.5	+0.090	0.05	0.7V _{Znom}
BZX84C36*	34	38	90	2.0	350	0.5	+0.090	0.05	0.7V _{Znom}
BZX84C39	37	41	130	2.0	350	0.5	+0.110	0.05	0.7V _{Znom}
BZX84C43	40	46	150	2.0	375	0.5	+0.110	0.05	0.7V _{Znom}
BZX84C47	44	50	170	2.0	375	0.5	+0.110	0.05	0.7V _{Znom}
BZX84C51	48	54	180	2.0	400	0.5	+0.110	0.05	0.7V _{Znom}

1. V_Z measured @ I_{ZT} using a pulse test. I_{ZT} pulse width = 5.0ms.

(*) Preferred Part.

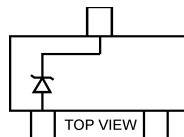

Pin Configuration

Type Number	Zener Voltage Range ¹		Max. Zener Impedance				Typical Temperature Coefficient	Max. Reverse Leakage Current	
	$V_Z @ I_{ZT}$		$Z_{ZT} @ I_{ZT}$		$Z_{ZK} @ I_{ZK}$		T_C	$I_R @ V_R$	
	Min V	Max V	Ω	mA	Ω	mA	% / °C	μA	V



200mW Zener Diodes (DUAL, Isolated) / SOT-363 NEW

BZX84C2V7S	2.5	2.9	100	5.0	600	1.0	-0.065	20	1.0
BZX84C3V0S	2.8	3.2	100	5.0	600	1.0	-0.060	10	1.0
BZX84C3V3S	3.1	3.5	95	5.0	600	1.0	-0.055	5.0	1.0
BZX84C3V6S	3.4	3.8	95	5.0	600	1.0	-0.055	5.0	1.0
BZX84C3V9S	3.7	4.1	90	5.0	600	1.0	-0.050	3.0	1.0
BZX84C4V3S	4.0	4.6	90	5.0	600	1.0	-0.035	3.0	1.0
BZX84C4V7S	4.4	5.0	80	5.0	500	1.0	-0.015	4.0	2.0
BZX84C5V1S	4.8	5.4	60	5.0	480	1.0	+0.005	2.0	2.0
BZX84C5V6S	5.2	6.0	40	5.0	400	1.0	+0.020	1.0	2.0
BZX84C6V2S	5.8	6.6	10	5.0	150	1.0	+0.030	3.0	4.0
BZX84C6V8S	6.4	7.2	15	5.0	80	1.0	+0.045	2.0	4.0
BZX84C7V5S	7.0	7.9	15	5.0	80	1.0	+0.050	1.0	5.0
BZX84C8V2S	7.7	8.7	15	5.0	80	1.0	+0.055	0.7	5.0
BZX84C9V1S	8.5	9.6	15	5.0	100	1.0	+0.065	0.5	6.0
BZX84C10S	9.4	10.6	20	5.0	150	1.0	+0.065	0.2	7.0
BZX84C11S	10.4	11.6	20	5.0	150	1.0	+0.070	0.1	8.0
BZX84C12S	11.4	12.7	25	5.0	150	1.0	+0.075	0.1	8.0
BZX84C13S	12.4	14.1	30	5.0	170	1.0	+0.080	0.1	8.0
BZX84C15S	13.8	15.6	30	5.0	200	1.0	+0.080	0.05	0.7V _{Znom}
BZX84C16S	15.3	17.1	40	5.0	200	1.0	+0.090	0.05	0.7V _{Znom}
BZX84C18S	16.8	19.1	45	5.0	225	1.0	+0.090	0.05	0.7V _{Znom}
BZX84C20S	18.8	21.2	55	5.0	225	1.0	+0.090	0.05	0.7V _{Znom}
BZX84C22S	20.8	23.3	55	5.0	250	1.0	+0.090	0.05	0.7V _{Znom}
BZX84C24S	22.8	25.6	70	5.0	250	1.0	+0.090	0.05	0.7V _{Znom}
BZX84C27S	25.1	28.9	80	2.0	300	0.5	+0.090	0.05	0.7V _{Znom}
BZX84C30S	28.0	32.0	80	2.0	300	0.5	+0.090	0.05	0.7V _{Znom}
BZX84C33S	31.0	35.0	80	2.0	325	0.5	+0.090	0.05	0.7V _{Znom}
BZX84C36S	34.0	38.0	90	2.0	350	0.5	+0.090	0.05	0.7V _{Znom}
BZX84C39S	37.0	41.0	130	2.0	350	0.5	+0.090	0.05	0.7V _{Znom}

1. V_Z measured @ I_{ZT} using a pulse test. I_{ZT} pulse width = 5.0ms.

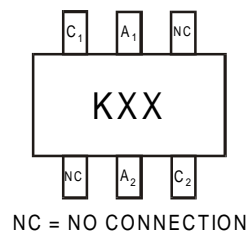

Pin Configuration

Type Number	Zener Voltage Range ¹			Max. Zener Impedance				Max. Reverse Leakage Current	
	V _Z @ I _{ZT}			Z _{VT} @ I _{ZT}		Z _{ZK} @ I _{ZK}		I _R @ V _R	
	Nom V	Min V	Max V	Ω	mA	Ω	mA	μA	V

200mW Zener Diodes (DUAL, Isolated) / SOT-363 (continued)



NEW

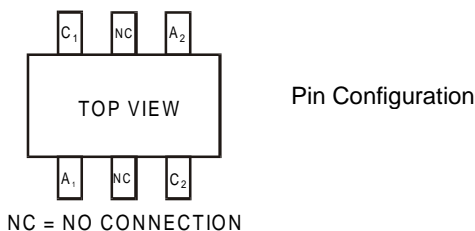

MMBZ5221BS	2.4	2.28	2.52	30	20	1200	0.25	100	1.0
MMBZ5222BS	2.5	2.38	2.63	30	20	1250	0.25	100	1.0
MMBZ5223BS	2.7	2.57	2.84	30	20	1300	0.25	75	1.0
MMBZ5225BS	3.0	2.85	3.15	30	20	1600	0.25	50	1.0
MMBZ5226BS	3.3	3.14	3.47	28	20	1600	0.25	25	1.0
MMBZ5227BS	3.6	3.42	3.78	24	20	1700	0.25	15	1.0
MMBZ5228BS	3.9	3.71	4.10	23	20	1900	0.25	10	1.0
MMBZ5229BS	4.3	4.09	4.52	22	20	2000	0.25	5.0	1.0
MMBZ5230BS	4.7	4.47	4.94	19	20	1900	0.25	5.0	2.0
MMBZ5231BS	5.1	4.85	5.36	17	20	2000	0.25	5.0	2.0
MMBZ5232BS	5.6	5.32	5.88	11	20	1900	0.25	5.0	3.0
MMBZ5234BS	6.2	5.89	6.51	7.0	20	1600	0.25	5.0	4.0
MMBZ5235BS	6.8	6.46	7.14	5.0	20	1600	0.25	3.0	5.0
MMBZ5236BS	7.5	7.13	7.88	6.0	20	1000	0.25	3.0	6.0
MMBZ5237BS	8.2	7.79	8.61	8.0	20	750	0.25	3.0	6.5
MMBZ5239BS	9.1	8.65	9.56	10	20	500	0.25	3.0	7.0
MMBZ5240BS	10	9.50	10.50	17	20	500	0.25	3.0	8.0
MMBZ5241BS	11	10.45	11.55	22	20	600	0.25	2.0	8.4
MMBZ5242BS	12	11.40	12.60	30	20	600	0.25	1.0	9.1
MMBZ5243BS	13	12.35	13.65	13	9.5	600	0.25	0.5	9.9
MMBZ5245BS	15	14.25	15.75	16	8.5	600	0.25	0.1	11
MMBZ5246BS	16	15.20	16.80	17	7.8	600	0.25	0.1	12
MMBZ5248BS	18	17.10	18.90	21	7.0	600	0.25	0.1	14
MMBZ5250BS	20	19.00	21.00	25	6.2	600	0.25	0.1	15
MMBZ5251BS	22	20.90	23.10	29	5.6	600	0.25	0.1	17
MMBZ5252BS	24	22.80	25.20	33	5.2	600	0.25	0.1	18
MMBZ5254BS	27	25.65	28.35	41	5.0	600	0.25	0.1	21
MMBZ5255BS	28	26.60	29.40	44	4.5	600	0.25	0.1	21
MMBZ5256BS	30	28.50	31.50	49	4.2	600	0.25	0.1	23
MMBZ5257BS	33	31.35	34.65	58	3.8	700	0.25	0.1	25
MMBZ5258BS	36	34.20	37.80	70	3.4	700	0.25	0.1	27
MMBZ5259BS	39	37.05	40.95	80	3.2	800	0.25	0.1	30

1. V_Z measured @ I_{ZT} using a pulse test. I_{ZT} pulse width = 5.0ms.



Type Number	Zener Voltage Range ¹		Max. Zener Impedance				Typical Temperature Coefficient	Min. Reverse Leakage Current
	V _Z @ I _{ZT}		Z _{ZT} @ I _{ZT}		Z _{ZK} @ I _{ZK}		T _C	V _R @ I _R = 0.1μA
	Min V	Max V	Ω	mA	Ω	mA	% / °C	V
200mW Zener Diodes / SOD-323  								
BZT52C2V7S	2.5	2.9	83	5.0	500	1.0	-0.065	—
BZT52C3V0S	2.8	3.2	95	5.0	500	1.0	-0.060	—
BZT52C3V3S	3.1	3.5	95	5.0	500	1.0	-0.055	—
BZT52C3V6S	3.4	3.8	95	5.0	500	1.0	-0.055	—
BZT52C3V9S	3.7	4.1	95	5.0	500	1.0	-0.050	—
BZT52C4V3S	4.0	4.6	95	5.0	500	1.0	-0.035	—
BZT52C4V7S	4.4	5.0	78	5.0	500	1.0	-0.015	—
BZT52C5V1S	4.8	5.4	60	5.0	480	1.0	+0.005	0.8
BZT52C5V6S	5.2	6.0	40	5.0	400	1.0	+0.020	1.0
BZT52C6V2S	5.8	6.6	10	5.0	200	1.0	+0.030	2.0
BZT52C6V8S	6.4	7.2	8.0	5.0	150	1.0	+0.045	3.0
BZT52C7V5S	7.0	7.9	7.0	5.0	50	1.0	+0.050	5.0
BZT52C8V2S	7.7	8.7	7.0	5.0	50	1.0	+0.055	6.0
BZT52C9V1S	8.5	9.6	10	5.0	50	1.0	+0.065	7.0
BZT52C10S	9.4	10.6	15	5.0	70	1.0	-0.065	7.5
BZT52C11S	10.4	11.6	20	5.0	70	1.0	+0.070	8.5
BZT52C12S	11.4	12.7	20	5.0	90	1.0	+0.075	9.0
BZT52C13S	12.4	14.1	25	5.0	110	1.0	+0.080	10
BZT52C15S	13.8	15.6	30	5.0	110	1.0	+0.080	11
BZT52C16S	15.3	17.1	40	5.0	170	1.0	+0.090	12
BZT52C18S	16.8	19.1	50	5.0	170	1.0	+0.090	14
BZT52C20S	18.8	21.2	50	5.0	220	1.0	+0.090	15
BZT52C22S	20.8	23.3	55	5.0	220	1.0	+0.090	17
BZT52C24S	22.8	25.6	80	5.0	220	1.0	+0.090	18
BZT52C27S	25.1	28.9	80	5.0	250	1.0	+0.090	20
BZT52C30S	28	32	80	5.0	250	1.0	+0.090	22.5
BZT52C33S	31	35	80	5.0	250	1.0	+0.090	25
BZT52C36S	34	38	90	5.0	250	1.0	+0.090	27
BZT52C39S	37	41	90	5.0	300	1.0	+0.110	29

1. V_Z measured @ I_{ZT} using a pulse test. I_{ZT} pulse width = 5.0ms.

Type Number	Zener Voltage Range ¹			Max. Zener Impedance				Max. Reverse Leakage Current	
	V _Z @ I _{ZT}			Z _{ZT} @ I _{ZT}		Z _{ZK} @ I _{ZK}		I _R @ V _R	
	Nom V	Min V	Max V	Ω	mA	Ω	mA	μA	V
200mW Zener Diodes / SOD-323 									
				NEW					
MMSZ5221BS	2.4	2.28	2.52	30	20	1200	0.25	100	1.0
MMSZ5222BS	2.5	2.38	2.63	30	20	1250	0.25	100	1.0
MMSZ5223BS	2.7	2.57	2.84	30	20	1300	0.25	75	1.0
MMSZ5225BS	3.0	2.85	3.15	30	20	1600	0.25	50	1.0
MMSZ5226BS	3.3	3.14	3.47	28	20	1600	0.25	25	1.0
MMSZ5227BS	3.6	3.42	3.78	24	20	1700	0.25	15	1.0
MMSZ5228BS	3.9	3.71	4.10	23	20	1900	0.25	10	1.0
MMSZ5229BS	4.3	4.09	4.52	22	20	2000	0.25	5.0	1.0
MMSZ5230BS	4.7	4.47	4.94	19	20	1900	0.25	5.0	2.0
MMSZ5231BS	5.1	4.85	5.36	17	20	1600	0.25	5.0	2.0
MMSZ5232BS	5.6	5.32	5.88	11	20	1600	0.25	5.0	3.0
MMSZ5234BS	6.2	5.89	6.51	7.0	20	1000	0.25	5.0	4.0
MMSZ5235BS	6.8	6.46	7.14	5.0	20	750	0.25	3.0	5.0
MMSZ5236BS	7.5	7.13	7.88	6.0	20	500	0.25	3.0	6.0
MMSZ5237BS	8.2	7.79	8.61	8.0	20	500	0.25	3.0	6.5
MMSZ5239BS	9.1	8.65	9.56	10	20	600	0.25	3.0	7.0
MMSZ5240BS	10	9.50	10.50	17	20	600	0.25	3.0	8.0
MMSZ5241BS	11	10.45	11.55	22	20	600	0.25	2.0	8.4
MMSZ5242BS	12	11.40	12.60	30	20	600	0.25	1.0	9.1
MMSZ5243BS	13	12.35	13.65	13	9.5	600	0.25	0.5	9.9
MMSZ5245BS	15	14.25	15.75	16	8.5	600	0.25	0.1	11
MMSZ5246BS	16	15.20	16.80	17	7.8	600	0.25	0.1	12
MMSZ5248BS	18	17.10	18.90	21	7.0	600	0.25	0.1	14
MMSZ5250BS	20	19.00	21.00	25	6.2	600	0.25	0.1	15
MMSZ5251BS	22	20.90	23.10	29	5.6	600	0.25	0.1	17
MMSZ5252BS	24	22.80	25.20	33	5.2	600	0.25	0.1	18
MMSZ5254BS	27	25.65	28.35	41	5.0	600	0.25	0.1	21
MMSZ5255BS	28	26.60	29.40	44	4.5	600	0.25	0.1	21
MMSZ5256BS	30	28.50	31.50	49	4.2	600	0.25	0.1	23
MMSZ5257BS	33	31.35	34.65	58	3.8	700	0.25	0.1	25
MMSZ5258BS	36	34.20	37.80	70	3.4	700	0.25	0.1	27
MMSZ5259BS	39	37.05	40.95	80	3.2	800	0.25	0.1	30

1. V_Z measured @ I_{ZT} using a pulse test. I_{ZT} pulse width = 5.0ms.

Type Number	Zener Voltage Range ¹		Max. Zener Impedance				Max. Reverse Leakage Current	
	$V_Z @ I_{ZT}$		$Z_{ZT} @ I_{ZT}$		$Z_{ZK} @ I_{ZK}$		$I_R @ V_R$	
	Min V	Max V	Ω	mA	Ω	mA	μA	V

200mW Zener Diodes / SOT-323 NEW



BZX84C2V7W	2.57	2.84	100	5.0	600	0.25	20	1.0
BZX84C3V0W	2.85	3.15	100	5.0	600	0.25	10	1.0
BZX84C3V3W	3.14	3.47	95	5.0	600	0.25	5.0	1.0
BZX84C3V6W	3.42	3.78	95	5.0	600	0.25	5.0	1.0
BZX84C3V9W	3.71	4.10	90	5.0	600	0.25	3.0	1.0
BZX84C4V3W	4.09	4.52	90	5.0	600	0.25	3.0	1.0
BZX84C4V7W	4.47	4.94	80	5.0	500	0.25	4.0	2.0
BZX84C5V1W	4.85	5.36	60	5.0	480	0.25	2.0	2.0
BZX84C5V6W	5.32	5.88	40	5.0	400	0.25	1.0	2.0
BZX84C6V2W	5.89	6.51	10	5.0	150	0.25	3.0	4.0
BZX84C6V8W	6.46	7.14	15	5.0	80	0.25	2.0	4.0
BZX84C7V5W	7.13	7.88	15	5.0	80	0.25	1.0	5.0
BZX84C8V2W	7.79	8.61	15	5.0	80	0.25	0.7	5.0
BZX84C9V1W	8.65	9.56	15	5.0	100	0.25	0.5	6.0
BZX84C10W	9.50	10.50	20	5.0	150	0.25	0.2	7.0
BZX84C11W	10.45	11.55	20	5.0	150	0.25	0.1	8.0
BZX84C12W	11.40	12.60	25	5.0	150	0.25	0.1	8.0
BZX84C13W	12.35	13.65	30	5.0	170	0.25	0.1	8.0
BZX84C15W	14.25	15.75	30	5.0	200	0.25	0.05	0.7V _{Znom}
BZX84C16W	15.20	16.80	40	5.0	200	0.25	0.05	0.7V _{Znom}
BZX84C18W	17.10	18.90	45	5.0	225	0.25	0.05	0.7V _{Znom}
BZX84C20W	19.00	21.00	55	5.0	225	0.25	0.05	0.7V _{Znom}
BZX84C22W	20.90	23.10	55	5.0	250	0.25	0.05	0.7V _{Znom}
BZX84C24W	22.80	25.20	70	5.0	250	0.25	0.05	0.7V _{Znom}
BZX84C27W	25.65	28.35	80	2.0	300	0.25	0.05	0.7V _{Znom}
BZX84C30W	28.50	31.50	80	2.0	300	0.25	0.05	0.7V _{Znom}
BZX84C33W	31.35	34.65	80	2.0	325	0.25	0.05	0.7V _{Znom}
BZX84C36W	34.20	37.80	90	2.0	350	0.25	0.05	0.7V _{Znom}
BZX84C39W	37.05	40.95	130	2.0	350	0.25	0.05	0.7V _{Znom}

1. V_Z measured @ I_{ZT} using a pulse test. I_{ZT} pulse width = 5.0ms.

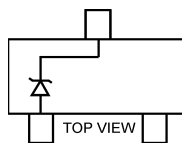

Pin Configuration

Type Number	Zener Voltage Range ¹			Max. Zener Impedance				Max. Reverse Leakage Current	
	V _Z @ I _{ZT}			Z _{ZT} @ I _{ZT}		Z _{ZK} @ I _{ZK}		I _R @ V _R	
	Nom V	Min V	Max V	Ω	mA	Ω	mA	μA	V

200mW Zener Diodes / SOT-323 NEW



MMBZ5221BW	2.4	2.28	2.52	30	20	1200	0.25	100	1.0
MMBZ5222BW	2.5	2.38	2.63	30	20	1250	0.25	100	1.0
MMBZ5223BW	2.7	2.57	2.84	30	20	1300	0.25	75	1.0
MMBZ5225BW	3.0	2.85	3.15	30	20	1600	0.25	50	1.0
MMBZ5226BW	3.3	3.14	3.47	28	20	1600	0.25	25	1.0
MMBZ5227BW	3.6	3.42	3.78	24	20	1700	0.25	15	1.0
MMBZ5228BW	3.9	3.71	4.10	23	20	1900	0.25	10	1.0
MMBZ5229BW	4.3	4.09	4.52	22	20	2000	0.25	5.0	1.0
MMBZ5230BW	4.7	4.47	4.94	19	20	1900	0.25	5.0	2.0
MMBZ5231BW	5.1	4.85	5.36	17	20	1600	0.25	5.0	2.0
MMBZ5232BW	5.6	5.32	5.88	11	20	1600	0.25	5.0	2.0
MMBZ5234BW	6.2	5.89	6.51	7.0	20	1000	0.25	5.0	4.0
MMBZ5235BW	6.8	6.46	7.14	5.0	20	750	0.25	3.0	4.0
MMBZ5236BW	7.5	7.13	7.88	6.0	20	500	0.25	3.0	5.0
MMBZ5237BW	8.2	7.79	8.61	8.0	20	500	0.25	3.0	5.0
MMBZ5239BW	9.1	8.65	9.56	10	20	600	0.25	3.0	6.0
MMBZ5240BW	10	9.50	10.50	17	20	600	0.25	3.0	7.0
MMBZ5241BW	11	10.45	11.55	22	20	600	0.25	2.0	8.0
MMBZ5242BW	12	11.40	12.60	30	20	600	0.25	1.0	8.4
MMBZ5243BW	13	12.35	13.65	13	9.5	600	0.25	0.5	9.1
MMBZ5245BW	15	14.25	15.75	16	8.5	600	0.25	0.1	9.9
MMBZ5246BW	16	15.20	16.80	17	7.8	600	0.25	0.1	11
MMBZ5248BW	18	17.10	18.90	21	7.0	600	0.25	0.1	14
MMBZ5250BW	20	19.00	21.00	25	6.2	600	0.25	0.1	15
MMBZ5251BW	22	20.90	23.10	29	5.6	600	0.25	0.1	17
MMBZ5252BW	24	22.80	25.20	33	5.2	600	0.25	0.1	18
MMBZ5254BW	27	25.65	28.35	41	5.0	600	0.25	0.1	21
MMBZ5255BW	28	26.60	29.40	44	4.5	600	0.25	0.1	21
MMBZ5256BW	30	28.50	31.50	49	4.2	600	0.25	0.1	23
MMBZ5257BW	33	31.35	34.65	58	3.8	700	0.25	0.1	25
MMBZ5258BW	36	34.20	37.80	70	3.4	700	0.25	0.1	27
MMBZ5259BW	39	37.05	40.95	80	3.2	800	0.25	0.1	30

1. V_Z measured @ I_{ZT} using a pulse test. I_{ZT} pulse width = 5.0ms.

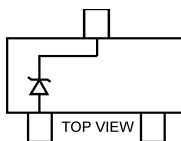

Pin Configuration

Type Number	Zener Voltage Range ¹		Max. Zener Impedance		Typical Temperature Coefficient	Min. Reverse Voltage
	V _Z @ I _{ZT} = 5.0mA		Z _{ZT} @ I _{ZT} = 5.0mA	Z _{ZK} @ I _{ZK} = 1.0mA	T _C	V _R @ I _R = 0.1μA
	Min V	Max V	Ω	Ω	% / °C	V

300mW Zener Diodes (DUAL Common Cathode) / SOT-23

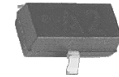

DZ23C2V7	2.5	2.9	83	500	-0.065	—
DZ23C3V0	2.8	3.2	95	500	-0.060	—
DZ23C3V3	3.1	3.5	95	500	-0.055	—
DZ23C3V6	3.4	3.8	95	500	-0.055	—
DZ23C3V9	3.7	4.1	95	500	-0.050	—
DZ23C4V3	4.0	4.6	95	500	-0.035	—
DZ23C4V7	4.4	5.0	78	500	-0.015	—
DZ23C5V1	4.8	5.4	60	480	+0.005	0.8
DZ23C5V6	5.2	6.0	40	400	+0.020	1.0
DZ23C6V2	5.8	6.6	10	200	+0.030	2.0
DZ23C6V8	6.4	7.2	8.0	150	+0.045	3.0
DZ23C7V5	7.0	7.9	7.0	50	+0.050	5.0
DZ23C8V2	7.7	8.7	7.0	50	+0.055	6.0
DZ23C9V1	8.5	9.6	10	50	+0.065	7.0
DZ23C10	9.4	10.6	15	70	+0.065	7.5
DZ23C11	10.4	11.6	20	70	+0.070	8.5
DZ23C12	11.4	12.7	20	90	+0.075	9.0
DZ23C13	12.4	14.1	25	110	+0.080	10.0
DZ23C15	13.8	15.6	30	110	+0.080	11.0
DZ23C16	15.3	17.1	40	170	+0.090	12.0
DZ23C18	16.8	19.1	50	170	+0.090	14.0
DZ23C20	18.8	21.2	50	220	+0.090	15.0
DZ23C22	20.8	23.3	55	220	+0.090	17.0
DZ23C24	22.8	25.6	80	220	+0.090	18.0
DZ23C27	25.1	28.9	80	250	+0.090	20.0
DZ23C30	28	32	80	250	+0.090	22.5
DZ23C33	31	35	80	250	+0.090	25.0
DZ23C36	34	38	90	250	+0.090	27.0
DZ23C39	37	41	90	300	+0.110	29.0
DZ23C43	40	46	100	700	+0.110	32.0
DZ23C47	44	50	100	750	+0.110	35.0
DZ23C51	48	54	100	750	+0.110	38.0

1. Tested with I_{ZT} current pulses. Pulse width = 5.0ms.

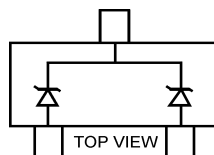

Pin Configuration

Type Number	Zener Voltage Range ¹		Max. Zener Impedance		Typical Temperature Coefficient	Min. Reverse Voltage	Max. Zener Current ¹	
	V _Z @ I _{ZT} = 5.0mA		Z _{ZT} @ I _{ZT} = 5.0mA	Z _{ZK} @ I _{ZK} = 1.0mA	T _C	V _R @ I _R = 0.1μA	I _{ZT} @ T _A = 45°C	I _{ZT} @ T _A = 25°C
	Min V	Max V	Ω	Ω	% / °C	V	mA	mA

410mW Zener Diodes / SOD-123

NEW

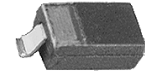

BZT52C2V7	2.5	2.9	83	500	-0.065	—	113	134
BZT52C3V0	2.8	3.2	95	500	-0.060	—	98	118
BZT52C3V3	3.1	3.5	95	500	-0.055	—	92	109
BZT52C3V6	3.4	3.8	95	500	-0.055	—	85	100
BZT52C3V9	3.7	4.1	95	500	-0.050	—	77	92
BZT52C4V3	4.0	4.6	95	500	-0.035	—	71	84
BZT52C4V7	4.4	5.0	78	500	-0.015	—	64	76
BZT52C5V1	4.8	5.4	60	480	+0.005	0.8	56	67
BZT52C5V6	5.2	6.0	40	400	+0.020	1.0	50	59
BZT52C6V2	5.8	6.6	10	200	+0.030	2.0	45	54
BZT52C6V8	6.4	7.2	8.0	150	+0.045	3.0	41	49
BZT52C7V5	7.0	7.9	7.0	50	+0.050	5.0	37	44
BZT52C8V2	7.7	8.7	7.0	50	+0.055	6.0	34	40
BZT52C9V1	8.5	9.6	10	50	+0.065	7.0	30	36
BZT52C10	9.4	10.6	15	70	+0.065	7.5	28	33
BZT52C11	10.4	11.6	20	70	+0.070	8.5	25	30
BZT52C12	11.4	12.7	20	90	+0.075	9.0	23	28
BZT52C13	12.4	14.1	25	110	+0.080	10.0	21	25
BZT52C15	13.8	15.6	30	110	+0.080	11.0	19	23
BZT52C16	15.3	17.1	40	170	+0.090	12.0	17	20
BZT52C18	16.8	19.1	50	170	+0.090	14.0	15	18
BZT52C20	18.8	21.2	50	220	+0.090	15.0	14	17
BZT52C22	20.8	23.3	55	220	+0.090	17.0	13	16
BZT52C24	22.8	25.6	80	220	+0.090	18.0	11	13
BZT52C27	25.1	28.9	80	250	+0.090	20.0	10	12
BZT52C30	28	32	80	250	+0.090	22.5	9.0	10
BZT52C33	31	35	80	250	+0.090	25.0	8.0	9.0
BZT52C36	34	38	90	250	+0.090	27.0	8.0	9.0
BZT52C39	37	41	90	300	+0.110	29.0	7.0	8.0
BZT52C43	40	46	100	700	+0.110	32.0	6.0	7.0
BZT52C47	44	50	100	750	+0.110	35.0	5.0	6.0
BZT52C51	48	54	100	750	+0.110	38.0	5.0	6.0

1. Tested with I_{ZT} current pulses. Pulse width = 5.0ms.

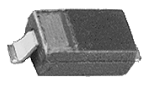
Type Number	Zener Voltage Range ¹			Max. Zener Impedance ²				Max. Reverse Leakage Current	
	V _Z @ I _{ZT}			Z _{ZT} @ I _{ZT}		Z _{ZK} @ I _{ZK}		I _R @ V _R	
	Nom V	Min V	Max V	Ω	mA	Ω	mA	μA	V
500mW Zener Diodes / SOD-123  									
MMSZ5221B	2.4	2.28	2.52	30	20	1200	0.25	100	1.0
MMSZ5222B	2.5	2.38	2.63	30	20	1250	0.25	100	1.0
MMSZ5223B	2.7	2.57	2.84	30	20	1300	0.25	75	1.0
MMSZ5225B	3.0	2.85	3.15	30	20	1600	0.25	50	1.0
MMSZ5226B	3.3	3.14	3.47	28	20	1600	0.25	25	1.0
MMSZ5227B	3.6	3.42	3.78	24	20	1700	0.25	15	1.0
MMSZ5228B	3.9	3.71	4.10	23	20	1900	0.25	10	1.0
MMSZ5229B	4.3	4.09	4.52	22	20	2000	0.25	5.0	1.0
MMSZ5230B	4.7	4.47	4.94	19	20	1900	0.25	5.0	2.0
MMSZ5231B	5.1	4.85	5.36	17	20	1600	0.25	5.0	2.0
MMSZ5232B	5.6	5.32	5.88	11	20	1600	0.25	5.0	3.0
MMSZ5234B	6.2	5.89	6.51	7.0	20	1000	0.25	5.0	4.0
MMSZ5235B	6.8	6.46	7.14	5.0	20	750	0.25	3.0	5.0
MMSZ5236B	7.5	7.13	7.88	6.0	20	500	0.25	3.0	6.0
MMSZ5237B	8.2	7.79	8.61	8.0	20	500	0.25	3.0	6.0
MMSZ5239B	9.1	8.65	9.56	10	20	600	0.25	3.0	6.5
MMSZ5240B	10	9.50	10.50	17	20	600	0.25	3.0	8.0
MMSZ5241B	11	10.45	11.55	22	20	600	0.25	3.0	8.4
MMSZ5242B	12	11.40	12.60	30	20	600	0.25	2.0	9.1
MMSZ5243B	13	12.35	13.65	13	9.5	600	0.25	1.0	9.9
MMSZ5245B	15	14.25	15.75	16	8.5	600	0.25	0.5	11
MMSZ5246B	16	15.20	16.80	17	7.8	600	0.25	0.1	12
MMSZ5248B	18	17.10	18.90	21	7.0	600	0.25	0.1	14
MMSZ5250B	20	19.00	21.00	25	6.2	600	0.25	0.1	15
MMSZ5251B	22	20.90	23.10	29	5.6	600	0.25	0.1	17
MMSZ5252B	24	22.80	25.20	33	5.2	600	0.25	0.1	18
MMSZ5254B	27	25.65	28.35	41	5.0	600	0.25	0.1	21
MMSZ5255B	28	26.60	29.40	44	4.5	600	0.25	0.1	21
MMSZ5256B	30	28.50	31.50	49	4.2	600	0.25	0.1	23
MMSZ5257B	33	31.35	34.65	58	3.8	700	0.25	0.1	25
MMSZ5258B	36	34.20	37.80	70	3.4	700	0.25	0.1	27
MMSZ5259B	39	37.05	40.95	80	3.2	800	0.25	0.1	30

1. Tested with pulses, T_P = 100ms.

2. Valid provided that electrodes are kept at ambient temperature.

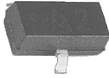
Type Number	Zener Voltage Range ¹			Max. Zener Impedance				Max. Reverse Leakage Current	
	V _Z @ I _{ZT}			Z _{ZT} @ I _{ZT}		Z _{ZK} @ I _{ZK}		V _R @ I _R	
	Nom V	Min V	Max V	Ω	mA	Ω	mA	μA	V
350mW Zener Diodes / SOT-23 NEW									
MMBZ5221B	2.4	2.28	2.52	30	20	1200	0.25	100	1.0
MMBZ5222B	2.5	2.38	2.63	30	20	1250	0.25	100	1.0
MMBZ5223B	2.7	2.57	2.84	30	20	1300	0.25	75	1.0
MMBZ5225B	3.0	2.85	3.15	30	20	1600	0.25	50	1.0
MMBZ5226B	3.3	3.14	3.47	28	20	1600	0.25	25	1.0
MMBZ5227B	3.6	3.42	3.78	24	20	1700	0.25	15	1.0
MMBZ5228B	3.9	3.71	4.10	23	20	1900	0.25	10	1.0
MMBZ5229B	4.3	4.09	4.52	22	20	2000	0.25	5.0	1.0
MMBZ5230B	4.7	4.47	4.94	19	20	1900	0.25	5.0	2.0
MMBZ5231B	5.1	4.85	5.36	17	20	2000	0.25	5.0	2.0
MMBZ5232B	5.6	5.32	5.88	11	20	1900	0.25	5.0	3.0
MMBZ5234B	6.2	5.89	6.51	7.0	20	1600	0.25	5.0	4.0
MMBZ5235B	6.8	6.46	7.14	5.0	20	1600	0.25	3.0	5.0
MMBZ5236B	7.5	7.13	7.88	6.0	20	1000	0.25	3.0	6.0
MMBZ5237B	8.2	7.79	8.61	8.0	20	750	0.25	3.0	6.5
MMBZ5239B	9.1	8.65	9.56	10	20	500	0.25	3.0	7.0
MMBZ5240B	10	9.50	10.50	17	20	500	0.25	3.0	8.0
MMBZ5241B	11	10.45	11.55	22	20	600	0.25	2.0	8.4
MMBZ5242B	12	11.40	12.60	30	20	600	0.25	1.0	9.1
MMBZ5243B	13	12.35	13.65	13	9.5	600	0.25	0.5	9.9
MMBZ5245B	15	14.25	15.75	16	8.5	600	0.25	0.1	11
MMBZ5246B	16	15.20	16.80	17	7.8	600	0.25	0.1	12
MMBZ5248B	18	17.10	18.90	21	7.0	600	0.25	0.1	14
MMBZ5250B	20	19.00	21.00	25	6.2	600	0.25	0.1	15
MMBZ5251B	22	20.90	23.10	29	5.6	600	0.25	0.1	17
MMBZ5252B	24	22.80	25.20	33	5.2	600	0.25	0.1	18
MMBZ5254B	27	25.65	28.35	41	5.0	600	0.25	0.1	21
MMBZ5255B	28	26.60	29.40	44	4.5	600	0.25	0.1	21
MMBZ5256B	30	28.50	31.50	49	4.2	600	0.25	0.1	23
MMBZ5257B	33	31.35	34.65	58	3.8	700	0.25	0.1	25
MMBZ5258B	36	34.20	37.80	70	3.4	700	0.25	0.1	27
MMBZ5259B	39	37.05	40.95	80	3.2	800	0.25	0.1	30

1. V_Z measured @ I_{ZT} using a pulse test. I_{ZT} pulse width = 5.0ms.

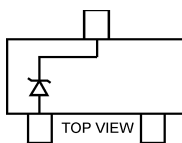

Pin Configuration

Type Number	Zener Voltage Range ¹				Max. Zener Impedance ²		Typical Temperature Coefficient	Max. Reverse Leakage Current	
	V _Z @ I _{ZT}				Z _{ZT} @ I _{ZK}		T _C	I _R @ V _R	
	Nom V	Min V	Max V	mA	Ω	mA	% / °C	μA	V

500mW Zener Diodes / MicroMELF NEW



BZM5221B	2.4	2.28	2.52	20	30	1200	-0.085	100	1.0
BZM5222B	2.5	2.38	2.63	20	30	1250	-0.085	100	1.0
BZM5223B	2.7	2.57	2.84	20	30	1300	-0.080	75	1.0
BZM5224B	2.8	2.66	2.94	20	30	1400	-0.080	50	1.0
BZM5225B	3.0	2.85	3.15	20	30	1600	-0.075	25	1.0
BZM5226B	3.3	3.14	3.47	20	28	1600	-0.070	15	1.0
BZM5227B	3.6	3.42	3.78	20	24	1700	-0.065	10	1.0
BZM5228B	3.9	3.71	4.10	20	23	1900	-0.060	5.0	1.0
BZM5229B	4.3	4.09	4.52	20	22	2000	+/-0.055	5.0	1.0
BZM5230B	4.7	4.47	4.94	20	19	1900	+/-0.030	5.0	2.0
BZM5231B	5.1	4.85	5.36	20	17	1600	+/-0.030	5.0	2.0
BZM5232B	5.6	5.32	5.88	20	11	1600	+/-0.038	5.0	3.0
BZM5233B	6.0	5.70	6.30	20	7.0	1600	+/-0.038	3.0	3.5
BZM5234B	6.2	5.89	6.51	20	7.0	1000	+0.045	3.0	4.0
BZM5235B	6.8	6.46	7.14	20	5.0	750	+0.050	3.0	5.0
BZM5236B	7.5	7.13	7.88	20	6.0	500	+0.058	3.0	6.0
BZM5237B	8.2	7.79	8.61	20	8.0	500	+0.062	3.0	6.5
BZM5238B	8.7	8.27	9.14	20	8.0	600	+0.065	2.0	6.5
BZM5239B	9.1	8.65	9.56	20	10	600	+0.068	1.0	7.0
BZM5240B	10	9.50	10.50	20	17	600	+0.075	0.5	8.0
BZM5241B	11	10.45	11.55	20	22	600	+0.076	0.1	8.4
BZM5242B	12	11.40	12.60	20	30	600	+0.077	0.1	9.1
BZM5243B	13	12.35	13.65	9.5	13	600	+0.079	0.1	9.9
BZM5244B	14	13.30	14.70	9.0	15	600	+0.082	0.1	10
BZM5245B	15	14.25	15.75	8.5	16	600	+0.082	0.1	11
BZM5246B	16	15.20	16.80	7.8	17	600	+0.083	0.1	12
BZM5247B	17	16.15	17.85	7.4	19	600	+0.084	0.1	13
BZM5248B	18	17.10	18.90	7.0	21	600	+0.085	0.1	14
BZM5249B	19	18.05	19.95	6.6	23	600	+0.086	0.1	14
BZM5250B	20	19.00	21.00	6.2	25	600	+0.086	0.1	15
BZM5251B	22	20.90	23.10	5.6	29	600	+0.087	0.1	17
BZM5252B	24	22.80	25.20	5.2	33	600	+0.087	0.1	18
BZM5253B	25	23.75	26.25	5.0	35	600	+0.089	0.1	19
BZM5254B	27	25.65	28.35	4.6	41	600	+0.090	0.1	21
BZM5255B	28	26.60	29.40	4.5	44	600	+0.091	0.1	21
BZM5256B	30	28.50	31.50	4.2	49	600	+0.091	0.1	23

1. Tested with pulses, T_P = 100ms.

2. Valid provided that electrodes are kept at ambient temperature.

Type Number	Zener Voltage Range ¹				Max. Zener Impedance ²		Typical Temperature Coefficient	Max. Reverse Leakage Current	
	V _Z @ I _{ZT}				Z _{ZT} @ I _{ZK}			T _C	I _R @ V _R
	Nom V	Min V	Max V	mA	Ω	mA	% / °C		μA

500mW Zener Diodes / MicroMELF (Continued)

NEW



BZM5257B	33	31.35	34.65	3.8	58	700	+0.092	0.1	25
BZM5258B	36	34.20	37.80	3.4	70	700	+0.093	0.1	27
BZM5259B	39	37.05	40.95	3.2	80	800	+0.094	0.1	30
BZM5260B	43	40.85	45.15	3.0	93	900	+0.095	0.1	33
BZM5261B	47	44.65	49.35	2.7	105	1000	+0.095	0.1	36
BZM5262B	51	48.45	53.55	2.5	125	1100	+0.096	0.1	39
BZM5263B	56	53.20	58.80	2.2	150	1300	+0.096	0.1	43
BZM5264B	60	57.00	63.00	2.1	170	1400	+0.097	0.1	46
BZM5265B	62	58.90	65.10	2.0	185	1400	+0.097	0.1	47
BZM5266B	68	64.60	71.40	1.8	230	1600	+0.097	0.1	52
BZM5267B	75	71.25	78.75	1.7	270	1700	+0.098	0.1	56

1. Tested with pulses, T_P = 100ms.

2. Valid provided that electrodes are kept at ambient temperature.

Type Number	Zener Voltage Range ¹			Max. Zener Impedance ²		Typical Temperature Coefficient	Max. Reverse Leakage Current	
	V _Z @ I _{ZT}			Z _{ZT} @ I _{ZK}		T _C	I _R @ V _R	
	Min V	Max V	mA	Ω	mA	% / °C	μA	V

500mW Zener Diodes / MicroMELF

NEW



BZM55C2V4	2.28	2.56	5.0	< 600	1.0	-0.09 to -0.06	< 50	1.0
BZM55C2V7	2.5	2.9	5.0	< 600	1.0	-0.09 to -0.06	< 10	1.0
BZM55C3V0	2.8	3.2	5.0	< 600	1.0	-0.08 to -0.05	< 4.0	1.0
BZM55C3V3	3.1	3.5	5.0	< 600	1.0	-0.08 to -0.05	< 2.0	1.0
BZM55C3V6	3.4	3.8	5.0	< 600	1.0	-0.08 to -0.05	< 2.0	1.0
BZM55C3V9	3.7	4.1	5.0	< 600	1.0	-0.08 to -0.05	< 2.0	1.0
BZM55C4V3	4.0	4.6	5.0	< 600	1.0	-0.06 to -0.03	< 1.0	1.0
BZM55C4V7	4.4	5.05	5.0	< 600	1.0	-0.05 to +0.02	< 0.5	1.0
BZM55C5V1	4.8	5.4	5.0	< 550	1.0	-0.02 to +0.02	< 0.1	1.0
BZM55C5V6	5.2	6.0	5.0	< 450	1.0	-0.05 to +0.05	< 0.1	1.0
BZM55C6V2	5.8	6.6	5.0	< 200	1.0	0.03 to 0.06	< 0.1	2.0
BZM55C6V8	6.4	7.2	5.0	< 150	1.0	0.03 to 0.07	< 0.1	3.0
BZM55C7V5	7.0	7.9	5.0	< 50	1.0	0.03 to 0.07	< 0.1	5.0
BZM55C8V2	7.7	8.7	5.0	< 50	1.0	0.03 to 0.08	< 0.1	6.2
BZM55C9V1	8.5	9.6	5.0	< 50	1.0	0.03 to 0.09	< 0.1	6.8
BZM55C10	9.4	10.6	5.0	< 70	1.0	0.03 to 0.10	< 0.1	7.5
BZM55C11	10.4	11.6	5.0	< 70	1.0	0.03 to 0.11	< 0.1	8.2
BZM55C12	11.4	12.7	5.0	< 90	1.0	0.03 to 0.11	< 0.1	9.1
BZM55C13	12.4	14.1	5.0	< 110	1.0	0.03 to 0.11	< 0.1	10
BZM55C15	13.8	15.6	5.0	< 110	1.0	0.03 to 0.11	< 0.1	11
BZM55C16	15.3	17.1	5.0	< 170	1.0	0.03 to 0.11	< 0.1	12
BZM55C18	16.8	19.1	5.0	< 170	1.0	0.03 to 0.11	< 0.1	13
BZM55C20	18.8	21.2	5.0	< 220	1.0	0.03 to 0.11	< 0.1	15
BZM55C22	20.8	23.3	5.0	< 220	1.0	0.04 to 0.12	< 0.1	16
BZM55C24	22.8	25.6	5.0	< 220	1.0	0.04 to 0.12	< 0.1	18
BZM55C27	25.1	28.9	5.0	< 220	1.0	0.04 to 0.12	< 0.1	20
BZM55C30	28	32	5.0	< 220	1.0	0.04 to 0.12	< 0.1	22
BZM55C33	31	35	5.0	< 220	1.0	0.04 to 0.12	< 0.1	24
BZM55C36	34	38	5.0	< 220	1.0	0.04 to 0.12	< 0.1	27
BZM55C39	37	41	2.5	< 500	1.0	0.04 to 0.12	< 0.1	30
BZM55C43	40	46	2.5	< 600	0.5	0.04 to 0.12	< 0.1	33
BZM55C47	44	50	2.5	< 700	0.5	0.04 to 0.12	< 0.1	36
BZM55C51	48	54	2.5	< 700	0.5	0.04 to 0.12	< 0.1	39
BZM55C56	52	60	2.5	< 1000	0.5	0.04 to 0.12	< 0.1	43
BZM55C62	58	66	2.5	< 1000	0.5	0.04 to 0.12	< 0.1	47
BZM44C68	64	72	2.5	< 1000	0.5	0.04 to 0.12	< 0.1	51
BZM55C75	70	79	2.5	< 1500	0.5	0.04 to 0.12	< 0.1	56

1. Tested with pulses, T_P = 100ms.

2. Valid provided that electrodes are kept at ambient temperature.

Type Number	Zener Voltage Range ¹			Max. Zener Impedance ²		Typical Temperature Coefficient	Max. Reverse Leakage Current	
	V _Z @ I _{ZT}			Z _{ZK} @ I _{ZK}		T _C	I _R @ V _R	
	Min V	Max V	mA	Ω	mA	% / °C	μA	V

500mW Zener Diodes / QuadromELF

NEW



BZT55C2V4	2.28	2.56	5.0	< 600	1.0	-0.09 to -0.06	< 50	1.0
BZT55C2V7	2.5	2.9	5.0	< 600	1.0	-0.09 to -0.06	< 10	1.0
BZT55C3V0	2.8	3.2	5.0	< 600	1.0	-0.08 to -0.05	< 4.0	1.0
BZT55C3V3	3.1	3.5	5.0	< 600	1.0	-0.08 to -0.05	< 2.0	1.0
BZT55C3V6	3.4	3.8	5.0	< 600	1.0	-0.08 to -0.05	< 2.0	1.0
BZT55C3V9	3.7	4.1	5.0	< 600	1.0	-0.08 to -0.05	< 2.0	1.0
BZT55C4V3	4.0	4.6	5.0	< 600	1.0	-0.06 to -0.03	< 1.0	1.0
BZT55C4V7	4.4	5.0	5.0	< 600	1.0	-0.05 to +0.02	< 0.5	1.0
BZT55C5V1	4.8	5.4	5.0	< 550	1.0	-0.02 to +0.02	< 0.1	1.0
BZT55C5V6	5.2	6.0	5.0	< 450	1.0	-0.05 to +0.05	< 0.1	1.0
BZT55C6V2	5.8	6.6	5.0	< 200	1.0	0.03 to 0.06	< 0.1	2.0
BZT55C6V8	6.4	7.2	5.0	< 150	1.0	0.03 to 0.07	< 0.1	3.0
BZT55C7V5	7.0	7.9	5.0	< 50	1.0	0.03 to 0.07	< 0.1	5.0
BZT55C8V2	7.7	8.7	5.0	< 50	1.0	0.03 to 0.08	< 0.1	6.2
BZT55C9V1	8.5	9.6	5.0	< 50	1.0	0.03 to 0.09	< 0.1	6.8
BZT55C10	9.4	10.6	5.0	< 70	1.0	0.03 to 0.10	< 0.1	7.5
BZT55C11	10.4	11.6	5.0	< 70	1.0	0.03 to 0.11	< 0.1	8.2
BZT55C12	11.4	12.7	5.0	< 90	1.0	0.03 to 0.11	< 0.1	9.1
BZT55C13	12.4	14.1	5.0	< 110	1.0	0.03 to 0.11	< 0.1	10
BZT55C15	13.8	15.6	5.0	< 110	1.0	0.03 to 0.11	< 0.1	11
BZT55C16	15.3	17.1	5.0	< 170	1.0	0.03 to 0.11	< 0.1	12
BZT55C18	16.8	19.1	5.0	< 170	1.0	0.03 to 0.11	< 0.1	13
BZT55C20	18.8	21.2	5.0	< 220	1.0	0.03 to 0.11	< 0.1	15
BZT55C22	20.8	23.3	5.0	< 220	1.0	0.04 to 0.12	< 0.1	16
BZT55C24	22.8	25.6	5.0	< 220	1.0	0.04 to 0.12	< 0.1	18
BZT55C27	25.1	28.9	5.0	< 220	1.0	0.04 to 0.12	< 0.1	20
BZT55C30	28	32	5.0	< 220	1.0	0.04 to 0.12	< 0.1	22
BZT55C33	31	35	5.0	< 220	1.0	0.04 to 0.12	< 0.1	24
BZT55C36	34	38	5.0	< 220	1.0	0.04 to 0.12	< 0.1	27
BZT55C39	37	41	2.5	< 500	0.5	0.04 to 0.12	< 0.1	30
BZT55C43	40	46	2.5	< 600	0.5	0.04 to 0.12	< 0.1	33
BZT55C47	44	50	2.5	< 700	0.5	0.04 to 0.12	< 0.1	36
BZT55C51	48	54	2.5	< 700	0.5	0.04 to 0.12	< 0.1	39
BZT55C56	52	60	2.5	< 1000	0.5	0.04 to 0.12	< 0.1	43
BZT55C62	58	66	2.5	< 1000	0.5	0.04 to 0.12	< 0.1	47
BZT55C68	64	72	2.5	< 1000	0.5	0.04 to 0.12	< 0.1	51
BZT55C75	70	79	2.5	< 1500	0.5	0.04 to 0.12	< 0.1	56

1. Tested with pulses, T_p = 100ms.

2. Valid provided that electrodes are kept at ambient temperature.

Type Number	Zener Voltage Range ¹			Max. Zener Impedance ²		Typical Temperature Coefficient	Max. Reverse Leakage Current	
	V _Z @ I _{ZT}			Z _{ZK} @ I _{ZK}		T _C	I _R @ V _R	
	Min V	Max V	mA	Ω	mA	% / °C	μA	V

500mW Zener Diodes / QuadromELF

NEW



TZQ5221B	2.28	2.52	20	30	20	-0.085	100	1.0
TZQ5222B	2.38	2.63	20	30	20	-0.085	100	1.0
TZQ5223B	2.57	2.84	20	30	20	-0.080	75	1.0
TZQ5224B	2.66	2.94	20	30	20	-0.080	75	1.0
TZQ5225B	2.85	3.15	20	30	20	-0.075	50	1.0
TZQ5226B	3.14	3.47	20	28	20	-0.070	25	1.0
TZQ5227B	3.42	3.78	20	24	20	-0.065	15	1.0
TZQ5228B	3.71	4.10	20	23	20	-0.060	10	1.0
TZQ5229B	4.09	4.52	20	22	20	+/-0.055	5.0	1.0
TZQ5230B	4.47	4.94	20	19	20	+/-0.030	5.0	2.0
TZQ5231B	4.85	5.36	20	17	20	+/-0.030	5.0	2.0
TZQ5232B	5.32	5.88	20	11	20	+0.038	5.0	3.0
TZQ5233B	5.70	6.30	20	7.0	20	+0.038	5.0	3.5
TZQ5234B	5.89	6.51	20	7.0	20	+0.045	5.0	4.0
TZQ5235B	6.46	7.14	20	5.0	20	+0.050	3.0	5.0
TZQ5236B	7.13	7.88	20	6.0	20	+0.058	3.0	6.0
TZQ5237B	7.79	8.61	20	8.0	20	+0.062	3.0	6.5
TZQ5238B	8.27	9.14	20	8.0	20	+0.065	3.0	6.5
TZQ5239B	8.65	9.56	20	10	20	+0.068	3.0	7.0
TZQ5240B	9.50	10.50	20	17	20	+0.075	3.0	8.0
TZQ5241B	10.45	11.55	20	22	20	+0.076	2.0	8.4
TZQ5242B	11.40	12.50	20	30	20	+0.077	1.0	9.1
TZQ5243B	12.35	13.65	9.5	13	9.5	+0.079	0.5	9.9
TZQ5244B	13.30	14.70	9.0	15	9.0	+0.082	0.1	10
TZQ5245B	14.25	15.75	8.5	16	8.5	+0.082	0.1	11
TZQ5246B	15.20	16.80	7.8	17	7.8	+0.083	0.1	12
TZQ5247B	16.15	17.85	7.4	19	7.4	+0.084	0.1	13
TZQ5248B	17.10	18.90	7.0	21	7.0	+0.085	0.1	14
TZQ5249B	18.05	19.95	6.6	23	6.6	+0.086	0.1	14
TZQ5250B	19.00	21.00	6.2	25	6.2	+0.086	0.1	15
TZQ5251B	20.90	23.10	5.6	29	5.6	+0.087	0.1	17
TZQ5252B	22.80	25.20	5.2	33	5.2	+0.087	0.1	18
TZQ5253B	23.75	26.25	5.0	35	5.0	+0.089	0.1	19
TZQ5254B	25.65	28.35	4.6	41	4.6	+0.090	0.1	21
TZQ5255B	26.60	29.40	4.5	44	4.5	+0.091	0.1	21
TZQ5256B	28.50	31.50	4.2	49	4.2	+0.091	0.1	23
TZQ5257B	31.35	34.65	3.8	58	3.8	+0.092	0.1	25
TZQ5258B	34.20	37.80	3.4	70	3.4	+0.093	0.1	27
TZQ5259B	37.05	40.95	3.2	80	3.2	+0.094	0.1	30

1. Tested with pulses, T_p = 100ms.
2. Valid provided that electrodes are kept at ambient temperature.

Type Number	Zener Voltage Range ¹			Max. Zener Impedance ²		Typical Temperature Coefficient	Max. Reverse Leakage Current	
	V _Z @ I _{ZT}			Z _{ZK} @ I _{ZK}		T _C	I _R @ V _R	
	Min V	Max V	mA	Ω	mA	% / °C	μA	V

500mW Zener Diodes / QuadromELF (Continued)

NEW



TZQ5260B	40.85	45.15	3.0	93	3.0	+0.095	0.1	33
TZQ5261B	44.65	49.35	2.7	105	2.7	+0.095	0.1	36
TZQ5262B	48.45	53.55	2.5	125	2.5	+0.096	0.1	39
TZQ5263B	53.20	58.80	2.2	150	2.2	+0.096	0.1	43
TZQ5264B	57.00	63.00	2.1	170	2.1	+0.097	0.1	46
TZQ5265B	58.90	65.10	2.0	180	2.0	+0.097	0.1	47
TZQ5266B	64.60	71.40	1.8	230	1.8	+0.097	0.1	52
TZQ5267B	71.25	78.75	1.7	270	1.7	+0.098	0.1	56

1. Tested with pulses, T_p = 100ms.

2. Valid provided that electrodes are kept at ambient temperature.

Type Number	Zener Voltage Range ¹				Max. Zener Impedance ²		Typical Temperature Coefficient	Max. Reverse Leakage Current	
	V _Z @ I _{ZT}				Z _{ZK} @ I _{ZK}		T _C	I _R @ V _R	
	Nom V	Min V	Max V	mA	Ω	mA	% / °C	μA	V

500mW Zener Diodes / miniMELF



ZMM5221B	2.4	2.28	2.52	20	30	20	-0.085	100	1.0
ZMM5222B	2.5	2.38	2.63	20	30	20	-0.085	100	1.0
ZMM5223B	2.7	2.57	2.84	20	30	20	-0.080	75	1.0
ZMM5224B	2.8	2.66	2.94	20	30	20	-0.080	75	1.0
ZMM5225B	3.0	2.85	3.15	20	29	20	-0.075	50	1.0
ZMM5226B	3.3	3.14	3.47	20	28	20	-0.070	25	1.0
ZMM5227B	3.6	3.42	3.78	20	24	20	-0.065	15	1.0
ZMM5228B*	3.9	3.71	4.10	20	23	20	-0.060	10	1.0
ZMM5229B	4.3	4.09	4.52	20	22	20	-0.055	5.0	1.0
ZMM5230B*	4.7	4.47	4.94	20	19	20	+0.030	5.0	2.0
ZMM5231B*	5.1	4.85	5.36	20	17	20	+0.030	5.0	2.0
ZMM5232B*	5.6	5.32	5.88	20	11	20	+0.038	5.0	3.0
ZMM5233B	6.0	5.70	6.30	20	7.0	20	+0.038	5.0	3.5
ZMM5234B*	6.2	5.89	6.51	20	7.0	20	+0.045	5.0	4.0
ZMM5235B*	6.8	6.46	7.14	20	5.0	20	+0.050	3.0	5.0
ZMM5236B*	7.5	7.13	7.88	20	6.0	20	+0.058	3.0	6.0
ZMM5237B	8.2	7.79	8.61	20	8.0	20	+0.062	3.0	6.5
ZMM5238B	8.7	8.27	9.14	20	8.0	20	+0.065	3.0	6.5
ZMM5239B*	9.1	8.65	9.56	20	10	20	+0.068	3.0	7.0
ZMM5240B*	10	9.50	10.50	20	17	20	+0.075	3.0	8.0
ZMM5241B	11	10.45	11.55	20	22	20	+0.076	2.0	8.4
ZMM5242B*	12	11.40	12.60	20	30	20	+0.077	1.0	9.1
ZMM5243B	13	12.35	13.65	9.5	13	9.5	+0.079	0.5	9.9
ZMM5244B*	14	13.30	14.70	9.0	15	9.0	+0.082	0.1	10
ZMM5245B*	15	14.24	15.75	8.5	16	8.5	+0.082	0.1	11
ZMM5246B*	16	15.20	16.80	7.8	17	7.8	+0.083	0.1	12
ZMM5247B	17	16.15	17.85	7.4	19	7.4	+0.084	0.1	13
ZMM5248B*	18	17.10	18.90	7.0	21	7.0	+0.085	0.1	14
ZMM5249B	19	18.05	19.95	6.6	23	6.6	+0.086	0.1	14
ZMM5250B*	20	19.00	21.00	6.2	25	6.2	+0.086	0.1	15
ZMM5251B*	22	20.90	23.10	5.6	29	5.6	+0.087	0.1	17
ZMM5252B*	24	22.80	25.20	5.2	33	5.2	+0.087	0.1	18
ZMM5253B	25	23.75	26.25	5.0	35	5.0	+0.089	0.1	19

1. Tested with pulses, T_p = 100ms.

2. Valid provided that electrodes are kept at ambient temperature.

(*) Preferred Part.

Type Number	Zener Voltage Range ¹				Max. Zener Impedance ²		Typical Temperature Coefficient	Max. Reverse Leakage Current	
	V _Z @ I _{ZT}				Z _{ZK} @ I _{ZK}		T _C	I _R @ V _R	
	Nom V	Min V	Max V	mA	Ω	mA	% / °C	μA	V

500mW Zener Diodes / miniMELF (Continued)



ZMM5254B*	27	25.65	28.35	4.6	41	4.6	+0.090	0.1	21
ZMM5255B	28	26.60	29.40	4.5	44	4.5	+0.091	0.1	21
ZMM5256B*	30	28.50	31.50	4.2	49	4.2	+0.091	0.1	23
ZMM5257B*	33	31.35	34.65	3.8	58	3.8	+0.092	0.1	25
ZMM5258B*	36	34.20	37.80	3.4	70	3.4	+0.093	0.1	27
ZMM5259B	39	37.05	40.95	3.2	80	3.2	+0.094	0.1	30
ZMM5260B	43	40.85	45.15	3.0	93	3.0	+0.095	0.1	33
ZMM5261B	47	44.65	49.35	2.7	105	2.7	+0.095	0.1	36
ZMM5262B	51	48.45	53.55	2.5	125	2.5	+0.096	0.1	39
ZMM5263B	56	53.20	58.80	2.2	150	2.2	+0.096	0.1	43
ZMM5264B	60	57.00	63.00	2.1	170	2.1	+0.097	0.1	46
ZMM5265B	62	58.90	65.10	2.0	185	2.0	+0.097	0.1	47
ZMM5266B	68	64.60	71.40	1.8	230	1.8	+0.097	0.1	52
ZMM5267B	75	71.25	78.75	1.7	270	1.7	+0.098	0.1	56

1. Tested with pulses, T_p = 100ms.

2. Valid provided that electrodes are kept at ambient temperature.

(*) Preferred Part.

Type Number	Zener Voltage Range ¹			Zener Impedance			Max. Reverse Leakage Current @ V _R			Typical Temperature Coefficient
	V _Z @ I _{ZT}			Z _{ZT} @ I _{ZT}	Z _{ZK} @ I _{ZK}		I _R @ T _A = 25°C	I _R @ T _A = 150°C	V _R	T _C
	Min V	Max V	mA	Ω	Ω	mA	μA	μA	V	% / °C

500mW Zener Diodes / miniMELF



ZMM2V4	2.28	2.56	5.0	<85	<600	1.0	<50	<100	1.0	-0.09 to -0.06
ZMM2V7	2.5	2.9	5.0	<85	<600	1.0	<10	<50	1.0	-0.09 to -0.06
ZMM3V0	2.8	3.2	5.0	<90	<600	1.0	<4.0	<40	1.0	-0.08 to -0.05
ZMM3V3	3.1	3.5	5.0	<90	<600	1.0	<2.0	<40	1.0	-0.08 to -0.05
ZMM3V6	3.4	3.8	5.0	<90	<600	1.0	<2.0	<40	1.0	-0.08 to -0.05
ZMM3V9	3.7	4.1	5.0	<90	<600	1.0	<2.0	<40	1.0	-0.08 to -0.05
ZMM4V3	4.0	4.6	5.0	<90	<600	1.0	<1.0	<20	1.0	-0.06 to -0.03
ZMM4V7	4.4	5.0	5.0	<80	<600	1.0	<0.5	<10	1.0	-0.05 to +0.02
ZMM5V1	4.8	5.4	5.0	<60	<550	1.0	<0.1	<2.0	1.0	-0.02 to +0.02
ZMM5V6	5.2	6.0	5.0	<40	<450	1.0	<0.1	<2.0	1.0	-0.05 to +0.05
ZMM6V2	5.8	6.6	5.0	<10	<200	1.0	<0.1	<2.0	2.0	0.03 to 0.06
ZMM6V8	6.4	7.2	5.0	<8.0	<150	1.0	<0.1	<2.0	3.0	0.03 to 0.07
ZMM7V5	7.0	7.9	5.0	<7.0	<50	1.0	<0.1	<2.0	5.0	0.03 to 0.07
ZMM8V2	7.7	8.7	5.0	<7.0	<50	1.0	<0.1	<2.0	6.2	0.03 to 0.08
ZMM9V1	8.5	9.6	5.0	<10	<50	1.0	<0.1	<2.0	6.8	0.03 to 0.09
ZMM10	9.4	10.6	5.0	<15	<70	1.0	<0.1	<2.0	7.5	0.03 to 0.01
ZMM11	10.4	11.6	5.0	<20	<70	1.0	<0.1	<2.0	8.2	0.03 to 0.11
ZMM12	11.4	12.7	5.0	<20	<90	1.0	<0.1	<2.0	9.1	0.03 to 0.11
ZMM13	12.4	14.1	5.0	<26	<110	1.0	<0.1	<2.0	10	0.03 to 0.11
ZMM15	13.8	15.6	5.0	<30	<110	1.0	<0.1	<2.0	11	0.03 to 0.11
ZMM16	15.3	17.1	5.0	<40	<170	1.0	<0.1	<2.0	12	0.03 to 0.11
ZMM18	16.8	19.1	5.0	<50	<170	1.0	<0.1	<2.0	13	0.03 to 0.11
ZMM20	18.8	21.2	5.0	<55	<220	1.0	<0.1	<2.0	15	0.03 to 0.11
ZMM22	20.8	23.3	5.0	<55	<220	1.0	<0.1	<2.0	16	0.04 to 0.12
ZMM24	22.8	25.6	5.0	<80	<220	1.0	<0.1	<2.0	18	0.04 to 0.12
ZMM27	25.1	28.9	5.0	<80	<220	1.0	<0.1	<2.0	20	0.04 to 0.12
ZMM30	28	32	5.0	<80	<220	1.0	<0.1	<2.0	22	0.04 to 0.12
ZMM33	31	35	5.0	<80	<220	1.0	<0.1	<2.0	24	0.04 to 0.12
ZMM36	34	38	5.0	<80	<220	1.0	<0.1	<2.0	27	0.04 to 0.12
ZMM39	37	41	2.5	<90	<500	0.5	<0.1	<5.0	30	0.04 to 0.12
ZMM43	40	46	2.5	<90	<600	0.5	<0.1	<5.0	33	0.04 to 0.12
ZMM47	44	50	2.5	<110	<700	0.5	<0.1	<5.0	36	0.04 to 0.12
ZMM51	48	54	2.5	<125	<700	0.5	<0.1	<10	39	0.04 to 0.12
ZMM56	52	72	2.5	<135	<1000	0.5	<0.1	<10	43	0.04 to 0.12
ZMM62	58	66	2.5	<150	<1000	0.5	<0.1	<10	47	0.04 to 0.12
ZMM68	64	72	2.5	<200	<1000	0.5	<0.1	<10	51	0.04 to 0.12
ZMM75	70	79	2.5	<250	<1500	0.5	<0.1	<10	56	0.04 to 0.12

1. Tested with pulses T_p = 20 ms.

Type Number	Zener Voltage Range ¹				Max. Zener Impedance		Typical Temperature Coefficient	Max. Reverse Leakage Current	
	V _Z @ I _{ZT}				Z _{ZT} @ I _{ZT}	Z _{ZK} @ I _{ZK} = 0.25mA	T _C	I _R @ V _R	
	Nom V	Min V	Max V	mA	Ω	Ω	% / °C	μA	V
500mW Zener Diodes / DO-35									
1N5221B	2.4	2.28	2.52	20	30	1200	-0.085	100	1.0
1N5222B	2.5	2.38	2.63	20	30	1250	-0.085	100	1.0
1N5223B	2.7	2.57	2.84	20	30	1300	-0.080	75	1.0
1N5224B	2.8	2.66	2.94	20	30	1400	-0.080	75	1.0
1N5225B	3.0	2.85	3.15	20	29	1600	-0.075	50	1.0
1N5226B*	3.3	3.14	3.47	20	28	1600	-0.070	25	1.0
1N5227B*	3.6	3.42	3.78	20	24	1700	-0.065	15	1.0
1N5228B*	3.9	3.71	4.10	20	23	1900	-0.060	10	1.0
1N5229B*	4.3	4.09	4.52	20	22	2000	-0.055	5.0	1.0
1N5230B*	4.7	4.47	4.94	20	19	1900	+0.030	5.0	2.0
1N5231B*	5.1	4.85	5.36	20	17	1600	+0.030	5.0	2.0
1N5232B*	5.6	5.32	5.88	20	11	1600	+0.038	5.0	3.0
1N5233B*	6.0	5.70	6.30	20	7.0	1600	+0.038	5.0	3.5
1N5234B*	6.2	5.89	6.51	20	7.0	1000	+0.045	5.0	4.0
1N5235B*	6.8	6.46	7.14	20	5.0	750	+0.050	3.0	5.0
1N5236B*	7.5	7.13	7.88	20	6.0	500	+0.058	3.0	6.0
1N5237B*	8.2	7.79	8.61	20	8.0	500	+0.062	3.0	6.5
1N5238B	8.7	8.27	9.14	20	8.0	600	+0.065	3.0	6.5
1N5239B*	9.1	8.65	9.56	20	10	600	+0.068	3.0	7.0
1N5240B*	10	9.50	10.50	20	17	600	+0.075	3.0	8.0
1N5241B	11	10.45	11.55	20	22	600	+0.076	2.0	8.4
1N5242B*	12	11.40	12.60	20	30	600	+0.077	1.0	9.1
1N5243B*	13	12.35	13.65	9.5	13	600	+0.079	0.5	9.9
1N5244B	14	13.30	14.70	9.0	15	600	+0.082	0.1	10
1N5245B*	15	14.25	15.75	8.5	16	600	+0.082	0.1	11
1N5246B*	16	15.20	16.80	7.8	17	600	+0.083	0.1	12
1N5247B*	17	16.15	17.85	7.4	19	600	+0.084	0.1	13
1N5248B*	18	17.10	18.90	7.0	21	600	+0.085	0.1	14
1N5249B	19	18.05	19.95	6.6	23	600	+0.086	0.1	14
1N5250B	20	19.00	21.00	6.2	25	600	+0.086	0.1	15
1N5251B*	22	20.90	23.10	5.6	29	600	+0.087	0.1	17
1N5252B	24	22.80	25.20	5.2	33	600	+0.087	0.1	18
1N5253B	25	23.75	26.25	5.0	35	600	+0.089	0.1	19
1N5254B	27	25.65	28.35	4.6	41	600	+0.090	0.1	21
1N5255B	28	26.60	29.40	4.5	44	600	+0.091	0.1	21
1N5256B*	30	28.50	31.50	4.2	49	600	+0.091	0.1	23
1N5257B*	33	31.35	34.65	3.8	58	700	+0.092	0.1	25

1. Measured under thermal equilibrium and DC (I_{ZT}) test conditions.

(*) Preferred Part.

Type Number	Zener Voltage Range ¹				Max. Zener Impedance		Typical Temperature Coefficient	Max. Reverse Leakage Current	
	$V_Z @ I_{ZT}$				$Z_{ZT} @ I_{ZT}$	$Z_{ZK} @ I_{ZK} = 0.25mA$	T_C	$I_R @ V_R$	
	Nom V	Min V	Max V	mA	Ω	Ω	% / °C	μA	V

500mW Zener Diodes / DO-35 (Continued)



1N5258B	36	34.20	37.80	3.4	70	700	+0.093	0.1	27
1N5259B	39	37.05	40.95	3.2	80	800	+0.094	0.1	30
1N5260B	43	40.85	45.15	3.0	93	900	+0.095	0.1	33
1N5261B	47	44.65	49.35	2.7	105	1000	+0.095	0.1	36
1N5262B	51	48.45	53.55	2.5	125	1100	+0.096	0.1	39
1N5263B*	56	53.20	58.80	2.2	150	1300	+0.096	0.1	43
1N5264B	60	57.00	63.00	2.1	170	1400	+0.097	0.1	46
1N5265B	62	58.90	65.10	2.0	185	1400	+0.097	0.1	47
1N5266B	68	64.60	71.40	1.8	230	1600	+0.097	0.1	52
1N5267B	75	71.25	78.75	1.7	270	1700	+0.098	0.1	56

1. Measured under thermal equilibrium and DC (I_{ZT}) test conditions.

(*) Preferred Part.

Type Number	Zener Voltage Range ¹			Zener Impedance			Max. Reverse Leakage Current @ V _R			Typical Temperature Coefficient
	V _Z @ I _{ZT}			Z _{ZT} @ I _{ZT}	Z _{ZT} @ I _{ZK}		I _R @ T _A = 25°C	I _R @ T _A = 150°C	V _R	T _C
	Min V	Max V	mA	Ω	Ω	mA	μA	μA	V	% / °C

500mW Zener Diodes / DO-35



BZX55C2V4	2.28	2.56	5.0	< 85	< 600	1.0	< 50	< 100	1.0	-0.09 to -0.06
BZX55C2V7	2.5	2.9	5.0	< 85	< 600	1.0	< 10	< 50	1.0	-0.09 to -0.06
BZX55C3V0	2.8	3.2	5.0	< 85	< 600	1.0	< 4.0	< 40	1.0	-0.08 to -0.05
BZX55C3V3	3.1	3.5	5.0	< 85	< 600	1.0	< 2.0	< 40	1.0	-0.08 to -0.05
BZX55C3V6	3.4	3.8	5.0	< 85	< 600	1.0	< 2.0	< 40	1.0	-0.08 to -0.05
BZX55C3V9	3.7	4.1	5.0	< 85	< 600	1.0	< 2.0	< 40	1.0	-0.08 to -0.05
BZX55C4V3	4.0	4.6	5.0	< 75	< 600	1.0	< 1.0	< 20	1.0	-0.06 to -0.03
BZX55C4V7	4.4	5.0	5.0	< 60	< 600	1.0	< 0.5	< 10	1.0	-0.05 to 0.02
BZX55C5V1	4.8	5.4	5.0	< 35	< 550	1.0	< 0.1	< 2.0	1.0	-0.02 to 0.02
BZX55C5V6	5.2	6.0	5.0	< 25	< 450	1.0	< 0.1	< 2.0	1.0	-0.05 to 0.05
BZX55C6V2	5.8	6.6	5.0	< 10	< 200	1.0	< 0.1	< 2.0	2.0	0.03 to 0.06
BZX55C6V8	6.4	7.2	5.0	< 8.0	< 150	1.0	< 0.1	< 2.0	3.0	0.03 to 0.07
BZX55C7V5	7.0	7.9	5.0	< 7.0	< 50	1.0	< 0.1	< 2.0	5.0	0.03 to 0.07
BZX55C8V2	7.7	8.7	5.0	< 7.0	< 50	1.0	< 0.1	< 2.0	6.2	0.03 to 0.08
BZX55C9V1	8.5	9.6	5.0	< 10	< 50	1.0	< 0.1	< 2.0	6.8	0.03 to 0.09
BZX55C10	9.4	10.6	5.0	< 15	< 70	1.0	< 0.1	< 2.0	7.5	0.03 to 0.10
BZX55C11	10.4	11.6	5.0	< 20	< 70	1.0	< 0.1	< 2.0	8.2	0.03 to 0.11
BZX55C12	11.4	12.7	5.0	< 20	< 90	1.0	< 0.1	< 2.0	9.1	0.03 to 0.11
BZX55C13	12.4	14.1	5.0	< 26	< 110	1.0	< 0.1	< 2.0	10	0.03 to 0.11
BZX55C15	13.8	15.6	5.0	< 30	< 110	1.0	< 0.1	< 2.0	11	0.03 to 0.11
BZX55C16	15.3	17.1	5.0	< 40	< 170	1.0	< 0.1	< 2.0	12	0.03 to 0.11
BZX55C18	16.8	19.1	5.0	< 50	< 170	1.0	< 0.1	< 2.0	13	0.03 to 0.11
BZX55C20	18.8	21.2	5.0	< 55	< 220	1.0	< 0.1	< 2.0	15	0.03 to 0.11
BZX55C22	20.8	23.3	5.0	< 55	< 220	1.0	< 0.1	< 2.0	16	0.04 to 0.12
BZX55C24	22.8	25.6	5.0	< 80	< 220	1.0	< 0.1	< 2.0	18	0.04 to 0.12
BZX55C27	25.1	28.9	5.0	< 80	< 220	1.0	< 0.1	< 2.0	20	0.04 to 0.12
BZX55C30	28	32	5.0	< 80	< 220	1.0	< 0.1	< 2.0	22	0.04 to 0.12
BZX55C33	31	35	5.0	< 80	< 220	1.0	< 0.1	< 2.0	24	0.04 to 0.12
BZX55C36	34	38	5.0	< 80	< 220	1.0	< 0.1	< 2.0	27	0.04 to 0.12
BZX55C39	37	41	2.5	< 90	< 500	0.5	< 0.1	< 5.0	30	0.04 to 0.12
BZX55C43	40	46	2.5	< 90	< 600	0.5	< 0.1	< 5.0	33	0.04 to 0.12
BZX55C47	44	50	2.5	< 110	< 700	0.5	< 0.1	< 5.0	36	0.04 to 0.12
BZX55C51	48	54	2.5	< 125	< 700	0.5	< 0.1	< 10	39	0.04 to 0.12
BZX55C56	52	60	2.5	< 135	< 1000	0.5	< 0.1	< 10	43	0.04 to 0.12
BZX55C62	58	66	2.5	< 150	< 1000	0.5	< 0.1	< 10	47	0.04 to 0.12
BZX55C68	64	72	2.5	< 200	< 1000	0.5	< 0.1	< 10	51	0.04 to 0.12
BZX55C75	70	79	2.5	< 250	< 1500	0.5	< 0.1	< 10	56	0.04 to 0.12

1. Measured under thermal equilibrium and DC (I_{ZT}) test conditions.

Type Number	Zener Voltage Range ¹		Max. Zener Impedance				Max. Reverse Leakage Current		Max. Zener Current ²
	$V_Z @ I_{ZT}$		$Z_{ZT} @ I_{ZT}$		$Z_{ZK} @ I_{ZK}$		$I_R @ V_R$		I_{ZM}
	Min V	Max V	Ω	mA	Ω	mA	μA	V	mA

1.0W Zener Diodes / SMA

NEW



SMAZ3V3	3.13	3.46	2.0	100	500	2.0	300	1.0	303
SMAZ3V6	3.42	3.78	2.0	100	500	2.0	150	1.0	278
SMAZ3V9	3.705	4.09	2.0	100	500	2.0	5.0	1.0	256
SMAZ4V3	4.08	4.51	2.0	100	500	2.0	50	1.0	232
SMAZ4V7	4.46	4.93	2.0	100	500	2.0	10.0	1.0	212
SMAZ5V1	4.84	5.35	5.0	100	350	2.0	5.0	1.0	196
SMAZ5V6	5.32	5.88	2.0	100	250	2.0	5.0	1.0	179
SMAZ6V2	5.89	6.51	2.0	100	200	2.0	5.0	1.0	161
SMAZ6V8	6.46	7.14	2.0	100	200	1.0	5.0	1.0	147
SMAZ7V5	7.13	7.88	2.0	100	450	1.0	5.0	2.0	133
SMAZ8V2	7.79	8.61	2.0	100	200	1.0	5.0	3.5	122
SMAZ9V1	8.65	9.56	4.0	50	200	1.0	5.0	3.5	110
SMAZ10	9.50	10.50	4.0	50	200	1.0	1.0	8.3	100
SMAZ12	11.40	12.60	7.0	50	150	1.0	1.0	9.1	83
SMAZ15	14.25	15.75	10	50	150	1.0	1.0	11.4	67
SMAZ16	15.20	16.80	15	25	150	1.0	0.5	12.2	63
SMAZ18	17.10	18.90	15	25	150	1.0	0.5	13.7	56
SMAZ20	19.00	21.00	15	25	180	1.0	0.5	15.2	50
SMAZ22	20.90	23.10	15	25	180	1.0	0.5	16.7	46
SMAZ24	22.80	25.20	15	25	180	1.0	0.5	18.2	42
SMAZ27	25.65	28.35	15	25	200	1.0	0.5	20.5	37
SMAZ30	28.50	31.50	15	25	250	1.0	0.5	22.8	33
SMAZ33	31.35	34.65	15	25	300	1.0	0.5	25.1	30
SMAZ36	34.20	37.80	40	10	350	1.0	0.5	27.4	28
SMAZ39	37.05	40.95	40	10	450	1.0	0.5	29.6	26

1. Tested with I_{ZT} current pulses. Pulse width = 50ms.

2. Device on fiberglass substrate.

Type Number	Nominal Zener Voltage Range ¹				Max. Zener Impedance			Max. Reverse Leakage Current		Max. Zener Current
	V _Z @ I _{ZT}				Z _{ZT} @ I _{ZT}	Z _{ZK} @ I _{ZK}		I _R @ V _R		I _{ZM}
	Nom V	Min V	Max V	mA	Ω	Ω	mA	μA	V	mA

1.0W Zener Diodes / DO-41



1N4728A*	3.3	3.14	3.47	76	10	400	1.0	100	1.0	303
1N4729A*	3.6	3.42	3.78	69	10	400	1.0	100	1.0	278
1N4730A	3.9	3.71	4.10	64	9.0	400	1.0	50	1.0	256
1N4731A	4.3	4.09	4.52	58	9.0	400	1.0	10	1.0	233
1N4732A	4.7	4.47	4.94	53	8.0	500	1.0	10	1.0	213
1N4733A*	5.1	4.85	5.36	49	7.0	550	1.0	10	1.0	196
1N4734A*	5.6	5.32	5.88	45	5.0	600	1.0	10	2.0	178
1N4735A*	6.2	5.89	6.51	41	2.0	700	1.0	10	3.0	161
1N4736A*	6.8	6.46	7.14	37	3.5	700	1.0	10	4.0	147
1N4737A	7.5	7.13	7.88	34	4.0	700	0.5	10	5.0	133
1N4738A*	8.2	7.79	8.61	31	4.5	700	0.5	10	6.0	122
1N4739A	9.1	8.65	9.56	28	5.0	700	0.5	10	7.0	110
1N4740A*	10	9.50	10.50	25	7.0	700	0.25	10	7.6	100
1N4741A*	11	10.45	11.55	23	8.0	700	0.25	5.0	8.4	91
1N4742A*	12	11.40	12.60	21	9.0	700	0.25	5.0	9.1	83
1N4743A*	13	12.35	13.65	19	10	700	0.25	5.0	9.9	77
1N4744A*	15	14.25	15.75	17	14	700	0.25	5.0	11.4	67
1N4745A*	16	15.20	16.80	15.5	16	700	0.25	5.0	12.2	63
1N4746A*	18	17.10	18.90	14	20	750	0.25	5.0	13.7	56
1N4747A*	20	19.00	21.00	12.5	22	750	0.25	5.0	15.2	50
1N4748A*	22	20.90	23.10	11.5	23	750	0.25	5.0	16.7	45
1N4749A	24	22.80	25.20	10.5	25	750	0.25	5.0	18.2	42
1N4750A*	27	25.65	28.35	9.5	35	750	0.25	5.0	20.6	37
1N4751A*	30	28.50	31.50	8.5	40	1000	0.25	5.0	22.8	33
1N4752A	33	31.35	34.65	7.5	45	1000	0.25	5.0	25.1	30
1N4753A*	36	34.20	37.80	7.0	50	1000	0.25	5.0	27.4	28
1N4754A	39	37.05	40.95	6.5	60	1000	0.25	5.0	29.7	26
1N4755A	43	40.85	45.15	6.0	70	1500	0.25	5.0	32.7	23
1N4756A	47	44.65	49.35	5.5	80	1500	0.25	5.0	35.8	21
1N4757A	51	48.45	53.55	5.0	95	1500	0.25	5.0	38.8	19
1N4758A*	56	53.20	58.80	4.5	110	2000	0.25	5.0	42.6	18
1N4759A	62	58.90	65.10	4.0	125	2000	0.25	5.0	47.1	16
1N4760A	68	64.60	71.40	3.7	150	2000	0.25	5.0	51.7	15
1N4761A	75	71.25	78.75	3.3	175	2000	0.25	5.0	56.0	13

1. Measured under thermal equilibrium and DC (I_{ZT}) test conditions. Standard voltage tolerance is 5%.

(*) Preferred Part.

Type Number	Zener Voltage Range ¹			Zener Impedance			Max. Reverse Leakage Current		Max. Zener Current
	V _Z @ I _{ZT}			Z _{ZT} @ I _{ZT}	Z _{ZT} @ I _{ZK}		I _R @ V _R		I _{ZM}
	Min V	Max V	mA	Ω	Ω	mA	μA	V	mA

1.3W Zener Diodes / DO-41



BZX85C2V7	2.5	2.9	80	20	400	1.0	150	1.0	481
BZX85C3V0	2.8	3.2	80	20	400	1.0	100	1.0	433
BZX85C3V3	3.1	3.5	80	20	400	1.0	40	1.0	394
BZX85C3V6	3.4	3.8	60	20	500	1.0	20	1.0	361
BZX85C3V9	3.7	4.1	60	15	500	1.0	10	1.0	333
BZX85C4V3	4.0	4.6	50	13	500	1.0	3.0	1.0	302
BZX85C4V7	4.4	5.0	45	13	600	1.0	3.0	1.0	277
BZX85C5V1	4.8	5.4	45	10	500	1.0	1.0	1.5	255
BZX85C5V6	5.2	6.0	45	7.0	400	1.0	1.0	2.0	232
BZX85C6V2	5.8	6.6	35	4.0	300	1.0	1.0	3.0	210
BZX85C6V8	6.4	7.2	35	3.5	300	1.0	1.0	4.0	191
BZX85C7V5	7.0	7.9	35	3.0	200	0.5	1.0	4.5	173
BZX85C8V2	7.7	8.7	25	5.0	200	0.5	1.0	6.2	159
BZX85C9V1	8.5	9.6	25	5.0	200	0.5	1.0	6.8	143
BZX85C10	9.4	10.6	25	7.0	200	0.5	0.5	7.0	130
BZX85C11	10.4	11.6	20	8.0	300	0.5	0.5	8.2	118
BZX85C12	11.4	12.7	20	9.0	350	0.5	0.5	9.1	108
BZX85C13	12.4	14.1	20	10	400	0.5	0.5	10	100
BZX85C15	13.8	15.6	15	15	500	0.5	0.5	11	87
BZX85C16	15.3	17.1	15	15	500	0.5	0.5	12	81
BZX85C18	16.8	19.1	15	20	500	0.5	0.5	13	72
BZX85C20	18.8	21.2	10	24	600	0.5	0.5	15	65
BZX85C22	20.8	23.3	10	25	600	0.5	0.5	16	59
BZX85C24	22.8	25.6	10	25	600	0.5	0.5	18	54
BZX85C27	25.1	28.9	8.0	30	750	0.25	0.5	20	48
BZX85C30	28	32	8.0	30	1000	0.25	0.5	22	43
BZX85C33	31	35	8.0	35	1000	0.25	0.5	24	39
BZX85C36	34	38	8.0	40	1000	0.25	0.5	27	36
BZX85C39	37	41	6.0	50	1000	0.25	0.5	30	33
BZX85C43	40	46	6.0	50	1000	0.25	0.5	33	30
BZX85C47	44	50	4.0	90	1500	0.25	0.5	36	28
BZX85C51	48	54	4.0	115	1500	0.25	0.5	39	25
BZX85C56	52	60	4.0	120	2000	0.25	0.5	43	23
BZX85C62	58	66	4.0	125	2000	0.25	0.5	47	21
BZX85C68	64	72	4.0	130	2000	0.25	0.5	51	19
BZX85C75	70	79	4.0	135	2000	0.25	0.5	56	17

1. Measured under thermal equilibrium and DC (I_{ZT}) test conditions.

Transient Voltage Suppressors

Type Number ¹	V _{RWM}	V _{BR} @ I _T (Note 2)			I _R @ V _{RWM}	V _C @ I _{PP}	
		Min.	Max.	I _T	UNI- / BI-	V	A
	V	V	V	mA	μA		
400W Transient Voltage Suppressors / SMA 							
SMAJ5.0(C)A	5.0	6.40	7.00	10	800/1600	9.2	43.5
SMAJ6.0(C)A	6.0	6.67	7.37	10	800/1600	10.3	38.8
SMAJ6.5(C)A	6.5	7.22	7.98	10	500/1000	11.2	35.7
SMAJ7.0(C)A	7.0	7.78	8.60	10	200/400	12.0	33.3
SMAJ7.5(C)A	7.5	8.33	9.21	1.0	100/200	12.9	31.0
SMAJ8.0(C)A	8.0	8.89	9.83	1.0	50/100	13.6	29.4
SMAJ8.5(C)A	8.5	9.44	10.4	1.0	10/20	14.4	27.7
SMAJ9.0(C)A	9.0	10.0	11.1	1.0	5/10	15.4	26.0
SMAJ10(C)A	10	11.1	12.3	1.0	5/10	17.0	23.5
SMAJ11(C)A	11	12.2	13.5	1.0	5.0	18.2	22.0
SMAJ12(C)A	12	13.3	14.7	1.0	5.0	19.9	20.1
SMAJ13(C)A	13	14.4	15.9	1.0	5.0	21.5	18.6
SMAJ14(C)A	14	15.6	17.2	1.0	5.0	23.2	17.2
SMAJ15(C)A	15	16.7	18.5	1.0	5.0	24.4	16.4
SMAJ16(C)A	16	17.8	19.7	1.0	5.0	26.0	15.3
SMAJ17(C)A	17	18.9	20.9	1.0	5.0	27.6	14.5
SMAJ18(C)A	18	20.0	22.1	1.0	5.0	29.2	13.7
SMAJ20(C)A	20	22.2	24.5	1.0	5.0	32.4	12.3
SMAJ22(C)A	22	24.4	26.9	1.0	5.0	35.5	11.2
SMAJ24(C)A	24	26.7	29.5	1.0	5.0	38.9	10.3
SMAJ26(C)A	26	28.9	25.3	1.0	5.0	42.1	9.5
SMAJ28(C)A	28	31.1	34.4	1.0	5.0	45.4	8.8
SMAJ30(C)A	30	33.3	36.8	1.0	5.0	48.4	8.3
SMAJ33(C)A	33	36.7	40.6	1.0	5.0	53.3	7.5
SMAJ36(C)A	36	40.0	44.2	1.0	5.0	58.1	6.9
SMAJ40(C)A	40	44.4	49.1	1.0	5.0	64.5	6.2
SMAJ43(C)A	43	47.8	52.8	1.0	5.0	69.4	5.7
SMAJ45(C)A	45	50.0	55.3	1.0	5.0	72.7	5.5
SMAJ48(C)A	48	53.3	58.9	1.0	5.0	77.4	5.2
SMAJ51(C)A	51	56.7	62.7	1.0	5.0	82.4	4.9
SMAJ54(C)A	54	60.0	66.3	1.0	5.0	87.1	4.6
SMAJ58(C)A	58	64.4	71.2	1.0	5.0	93.6	4.3
SMAJ60(C)A	60	66.7	73.7	1.0	5.0	96.8	4.1
SMAJ64(C)A	64	71.1	78.6	1.0	5.0	103	3.9
SMAJ70(C)A	70	77.8	86.0	1.0	5.0	113	3.5

1. 'C' suffix denotes bi-directional device.
2. V_{BR} measured with I_T current pulse = 300μs.

Type Number ¹	V _{RWM}	V _{BR} @ I _T (Note 2)			I _R @ V _{RWM}	V _C @ I _{PP}	
		Min.	Max.	I _T	UNI- / BI-	V	A
	V	V	V	mA	μA		

400W Transient Voltage Suppressors / SMA (Continued)



SMAJ75(C)A	75	83.3	92.1	1.0	5.0	121	3.3
SMAJ78(C)A	78	86.7	95.8	1.0	5.0	126	2.2
SMAJ85(C)A	85	94.4	104.0	1.0	5.0	137	2.9
SMAJ90(C)A	90	100.0	111.0	1.0	5.0	146	2.7
SMAJ100(C)A	100	111.0	123.0	1.0	5.0	162	2.5
SMAJ110(C)A	110	122.0	135.0	1.0	5.0	177	2.3
SMAJ120(C)A	120	133.0	147.0	1.0	5.0	193	2.0
SMAJ130(C)A	130	144.0	159.0	1.0	5.0	209	1.9
SMAJ150(C)A	150	167.0	185.0	1.0	5.0	243	1.6
SMAJ160(C)A	160	178.0	197.0	1.0	5.0	259	1.5
SMAJ170(C)A	170	189.0	209.0	1.0	5.0	275	1.4

500W Transient Voltage Suppressors / DO-15



SA5.0(C)A*	5.0	6.40	7.00	10	600/1200	9.2	54.3
SA6.0(C)A*	6.0	6.67	7.37	10	600/1200	10.3	48.5
SA6.5(C)A*	6.5	7.22	7.98	10	400/800	11.2	44.7
SA7.0(C)A	7.0	7.78	8.60	10	150/300	12.0	41.7
SA7.5(C)A	7.5	8.33	9.21	1.0	50/100	12.9	38.8
SA8.0(C)A	8.0	8.89	9.83	1.0	25/50	13.6	36.7
SA8.5(C)A	8.5	9.44	10.4	1.0	10/20	14.4	34.7
SA9.0(C)A	9.0	10.0	11.1	1.0	5.0/10	15.4	32.5
SA10(C)A*	10	11.1	12.3	1.0	3.0/6.0	17.0	29.4
SA11(C)A	11	12.2	13.5	1.0	3.0	18.2	27.4
SA12(C)A*	12	13.3	14.7	1.0	3.0	19.9	25.1
SA13(C)A	13	14.4	15.9	1.0	3.0	21.5	23.2
SA14(C)A	14	15.6	17.2	1.0	3.0	23.2	21.5
SA15(C)A*	15	16.7	18.5	1.0	3.0	24.4	20.6
SA16(C)A	16	17.8	19.7	1.0	3.0	26.0	19.2
SA17(C)A	17	18.9	20.9	1.0	3.0	27.6	18.1
SA18(C)A*	18	20.0	22.1	1.0	3.0	29.2	17.2
SA20(C)A*	20	22.2	24.5	1.0	3.0	32.4	15.4
SA22(C)A	22	24.4	26.9	1.0	3.0	35.5	14.1
SA24(C)A	24	26.7	29.5	1.0	3.0	38.9	12.8
SA26(C)A	26	28.9	31.9	1.0	3.0	42.1	11.9
SA28(C)A	28	31.1	34.4	1.0	3.0	45.4	11.0
SA30(C)A*	30	33.3	36.8	1.0	3.0	48.4	10.3
SA33(C)A	33	36.7	40.6	1.0	3.0	53.3	9.4
SA36(C)A	36	40.0	44.2	1.0	3.0	58.1	8.6
SA40(C)A	40	44.4	49.1	1.0	3.0	64.5	7.8

1. 'C' suffix denotes bi-directional device.
2. V_{BR} measured with I_T current pulse = 300μs.

(*) Preferred Part.

Type Number ¹	V _{RWM}	V _{BR} @ I _T (Note 2)			I _R @ V _{RWM}	V _C @ I _{PP}	
		Min.	Max.	I _T	UNI- / BI-	V	A
	V	V	V	mA	μA		

500W Transient Voltage Suppressors / DO-15 (Continued)



SA43(C)A	43	47.8	52.8	1.0	3.0	69.4	7.2
SA45(C)A	45	50.0	55.3	1.0	3.0	72.7	6.9
SA48(C)A	48	53.3	58.9	1.0	3.0	77.4	6.5
SA51(C)A*	51	56.7	62.7	1.0	3.0	82.4	6.1
SA54(C)A	54	60.0	66.3	1.0	3.0	87.1	5.7
SA58(C)A	58	64.4	71.2	1.0	3.0	93.6	5.3
SA60(C)A	60	66.7	73.7	1.0	3.0	96.8	5.2
SA64(C)A	64	71.1	78.6	1.0	3.0	103.0	4.9
SA70(C)A	70	77.8	86.0	1.0	3.0	113.0	4.4
SA75(C)A	75	83.3	92.1	1.0	3.0	121.0	4.1
SA78(C)A	78	86.7	95.8	1.0	3.0	126.0	4.0
SA85(C)A	85	94.4	104.0	1.0	3.0	137.0	3.6
SA90(C)A	90	100.0	111.0	1.0	3.0	146.0	3.4
SA100(C)A	100	111.0	123.0	1.0	3.0	162.0	3.1
SA110(C)A	110	122.0	135.0	1.0	3.0	177.0	2.8
SA120(C)A	120	133.0	147.0	1.0	3.0	193.0	2.6
SA130(C)A	130	144.0	159.0	1.0	3.0	209.0	2.4
SA150(C)A	150	167.0	185.0	1.0	3.0	243.0	2.1
SA160(C)A	160	178.0	197.0	1.0	3.0	259.0	1.9
SA170(C)A	170	189.0	209.0	1.0	3.0	275.0	1.8

600W Transient Voltage Suppressors / SMB

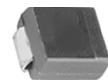

SMBJ5.0(C)A*	5.0	6.40	7.23	10	800/1600	9.2	65.2
SMBJ6.0(C)A*	6.0	6.67	7.67	10	800/1600	10.3	58.3
SMBJ6.5(C)A*	6.5	7.22	8.30	10	500/1000	11.2	53.6
SMBJ7.0(C)A	7.0	7.78	8.95	10	200/400	12.0	50.0
SMBJ7.5(C)A*	7.5	8.33	9.58	1.0	100/200	12.9	46.5
SMBJ8.0(C)A	8.0	8.89	10.23	1.0	50/100	13.6	44.1
SMBJ8.5(C)A	8.5	9.44	10.82	1.0	10/20	14.4	41.7
SMBJ9.0(C)A	9.0	10.00	11.50	1.0	5.0/10	15.4	39.0
SMBJ10(C)A*	10.0	11.10	12.80	1.0	5.0/10	17.0	35.3
SMBJ11(C)A	11.0	12.20	14.40	1.0	5.0	18.2	33.0
SMBJ12(C)A*	12.0	13.30	15.30	1.0	5.0	19.9	30.2
SMBJ13(C)A*	13.0	14.40	16.50	1.0	5.0	21.5	27.9
SMBJ14(C)A	14.0	15.60	17.90	1.0	5.0	23.2	25.8
SMBJ15(C)A*	15.0	16.70	19.20	1.0	5.0	24.4	24.0
SMBJ16(C)A	16.0	17.80	20.50	1.0	5.0	26.0	23.1
SMBJ17(C)A*	17.0	18.90	21.70	1.0	5.0	27.6	21.7
SMBJ18(C)A*	18.0	20.00	23.30	1.0	5.0	29.2	20.5
SMBJ20(C)A*	20.0	22.20	25.50	1.0	5.0	32.4	18.5

1. 'C' suffix denotes bi-directional device.
 2. V_{BR} measured with I_T current pulse = 300μs.
- (*) Preferred Part.

Type Number ¹	V _{RWM}	V _{BR} @ I _T (Note 2)			I _R @ V _{RWM}	V _C @ I _{PP}	
		Min.	Max.	I _T	UNI- / BI-	V	A
	V	V	V	mA	μA		

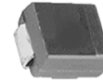

600W Transient Voltage Suppressors / SMB (Continued)

SMBJ22(C)A*	22.0	24.40	28.00	1.0	5.0	35.5	16.9
SMBJ24(C)A*	24.0	26.70	30.70	1.0	5.0	38.9	15.4
SMBJ26(C)A*	26.0	28.90	33.20	1.0	5.0	42.1	14.2
SMBJ28(C)A*	28.0	31.10	35.80	1.0	5.0	45.4	13.2
SMBJ30(C)A*	30.0	33.30	38.30	1.0	5.0	48.4	12.4
SMBJ33(C)A*	33.0	36.70	42.20	1.0	5.0	53.3	11.3
SMBJ36(C)A*	36.0	40.00	46.00	1.0	5.0	58.1	10.3
SMBJ40(C)A*	40.0	44.40	51.10	1.0	5.0	64.5	9.3
SMBJ43(C)A*	43.0	47.80	54.90	1.0	5.0	69.4	8.6
SMBJ45(C)A*	45.0	50.00	57.50	1.0	5.0	72.7	8.3
SMBJ48(C)A	48.0	53.30	61.30	1.0	5.0	77.4	7.7
SMBJ51(C)A	51.0	56.70	65.20	1.0	5.0	82.4	7.3
SMBJ54(C)A*	54.0	60.00	69.00	1.0	5.0	87.1	6.9
SMBJ58(C)A	58.0	64.40	74.60	1.0	5.0	93.6	6.4
SMBJ60(C)A	60.0	66.70	76.70	1.0	5.0	96.8	6.2
SMBJ64(C)A	64.0	71.10	81.80	1.0	5.0	103.0	5.8
SMBJ70(C)A*	70.0	77.80	89.50	1.0	5.0	113.0	5.3
SMBJ75(C)A	75.0	83.30	95.80	1.0	5.0	121.0	4.9
SMBJ78(C)A	78.0	86.70	99.70	1.0	5.0	126.0	4.7
SMBJ85(C)A*	85.0	94.40	108.20	1.0	5.0	137.0	4.4
SMBJ90(C)A	90.0	100.00	115.50	1.0	5.0	146.0	4.1
SMBJ100(C)A*	100.0	111.00	128.00	1.0	5.0	162.0	3.7
SMBJ110(C)A*	110.0	122.00	140.00	1.0	5.0	177.0	3.4
SMBJ120(C)A	120.0	133.00	153.00	1.0	5.0	193.0	3.1
SMBJ130(C)A	130.0	144.00	165.50	1.0	5.0	209.0	2.9
SMBJ150(C)A	150.0	167.00	192.50	1.0	5.0	243.0	2.5
SMBJ160(C)A	160.0	178.00	205.00	1.0	5.0	259.0	2.3
SMBJ170(C)A	170.0	189.00	217.50	1.0	5.0	275.0	2.2

600W Transient Voltage Suppressors / DO-15



P6KE6.8(C)A*	5.80	6.45	7.14	10	1000/2000	10.5	57.00
P6KE7.5(C)A*	6.40	7.13	7.88	10	500/1000	11.3	53.00
P6KE8.2(C)A*	7.02	7.79	8.61	10	200/400	12.1	50.00
P6KE9.1(C)A*	7.78	8.65	9.55	1.0	50/100	13.4	45.00
P6KE10(C)A*	8.55	9.50	10.50	1.0	10/20	14.5	41.00
P6KE11(C)A	9.40	10.50	11.60	1.0	5.0	15.6	38.00
P6KE12(C)A*	10.20	11.40	12.60	1.0	5.0	16.7	36.00
P6KE13(C)A	11.10	12.40	13.70	1.0	5.0	18.2	33.00
P6KE15(C)A*	12.80	14.30	15.80	1.0	5.0	21.2	28.00
P6KE16(C)A*	13.60	15.20	16.80	1.0	5.0	22.5	27.00

1. 'C' suffix denotes bi-directional device.
 2. V_{BR} measured with I_T current pulse = 300μs.
- (*) Preferred Part.

Type Number ¹	V _{RWM}	V _{BR} @ I _T (Note 2)			I _R @ V _{RWM}	V _C @ I _{PP}	
		Min.	Max.	I _T	UNI- / BI-	V	A
	V	V	V	mA	μA		
600W Transient Voltage Suppressors / DO-15 (Continued)							
P6KE18(C)A*	15.30	17.10	18.90	1.0	5.0	25.2	24.00
P6KE20(C)A*	17.10	19.00	21.00	1.0	5.0	27.7	22.00
P6KE22(C)A	18.80	20.90	23.10	1.0	5.0	30.6	20.00
P6KE24(C)A*	20.50	22.80	25.20	1.0	5.0	33.2	18.00
P6KE27(C)A*	23.10	25.70	28.40	1.0	5.0	37.5	16.00
P6KE30(C)A*	25.60	28.50	31.50	1.0	5.0	41.4	14.40
P6KE33(C)A*	28.20	31.40	34.70	1.0	5.0	45.7	13.20
P6KE36(C)A*	30.80	34.20	37.80	1.0	5.0	49.9	12.00
P6KE39(C)A*	33.30	37.10	41.00	1.0	5.0	53.9	11.20
P6KE43(C)A	36.80	40.90	45.20	1.0	5.0	59.3	10.10
P6KE47(C)A	40.20	44.70	49.40	1.0	5.0	64.8	9.30
P6KE51(C)A*	43.60	48.50	53.60	1.0	5.0	70.1	8.60
P6KE56(C)A	47.80	53.20	58.80	1.0	5.0	77.0	7.80
P6KE62(C)A*	53.00	58.90	65.10	1.0	5.0	85.0	7.10
P6KE68(C)A*	58.10	64.60	71.40	1.0	5.0	92.0	6.50
P6KE75(C)A*	64.10	71.30	78.80	1.0	5.0	103.0	5.80
P6KE82(C)A	70.10	77.90	86.10	1.0	5.0	113.0	5.30
P6KE91(C)A	77.80	86.50	95.50	1.0	5.0	125.0	4.80
P6KE100(C)A*	85.50	95.00	105.0	1.0	5.0	137.0	4.40
P6KE110(C)A	94.00	105.0	116.0	1.0	5.0	152.0	4.00
P6KE120(C)A	102.00	114.0	126.0	1.0	5.0	165.0	3.60
P6KE130(C)A*	111.00	124.0	137.0	1.0	5.0	179.0	3.30
P6KE150(C)A*	128.00	143.0	158.0	1.0	5.0	207.0	2.90
P6KE160(C)A	136.00	152.0	168.0	1.0	5.0	219.0	2.70
P6KE170(C)A	145.00	162.0	179.0	1.0	5.0	234.0	2.60
P6KE180(C)A*	154.00	171.0	189.0	1.0	5.0	246.0	2.40
P6KE200(C)A*	171.00	190.0	210.0	1.0	5.0	274.0	2.20
P6KE220(C)A	185.00	209.0	231.0	1.0	5.0	328.0	1.83
P6KE250(C)A	214.00	237.0	263.0	1.0	5.0	344.0	1.75
P6KE300(C)A	256.0	285.0	315.0	1.0	5.0	414.0	1.45
P6KE350(C)A	300.0	332.0	368.0	1.0	5.0	482.0	1.25
P6KE400(C)A*	342.0	380.0	420.0	1.0	5.0	548.0	1.10



1. 'C' suffix denotes bi-directional device.
2. Type number marking may contain a 'V' or dash in place of a decimal point.
(*) Preferred Part.

Type Number ¹	V _{RWM}	V _{BR} @ I _T (Note 2)			I _R @ V _{RWM}	V _C @ I _{PP}	
		Min.	Max.	I _T	UNI- / BI-	V	A
	V	V	V	mA	μA		

1500W Transient Voltage Suppressors / SMC



SMCJ5.0(C)A*	5.0	6.40	7.25	10	1000/2000	9.2	163.0
SMCJ6.0(C)A*	6.0	6.67	7.67	10	1000/2000	10.3	145.6
SMCJ6.5(C)A	6.5	7.22	8.30	10	500/1000	11.2	133.9
SMCJ7.0(C)A	7.0	7.78	8.95	10	200/400	12.0	125.0
SMCJ7.5(C)A	7.5	8.33	9.58	1.0	100/200	12.9	116.3
SMCJ8.0(C)A	8.0	8.89	10.23	1.0	50/100	13.6	110.3
SMCJ8.5(C)A	8.5	9.44	10.82	1.0	20/40	14.4	104.2
SMCJ9.0(C)A	9.0	10.00	11.50	1.0	10/20	15.4	97.4
SMCJ10(C)A	10.0	11.10	12.80	1.0	5/10	17.0	88.2
SMCJ11(C)A	11.0	12.20	14.40	1.0	5.0	18.2	82.4
SMCJ12(C)A*	12.0	13.30	15.30	1.0	5.0	19.9	75.3
SMCJ13(C)A	13.0	14.40	16.50	1.0	5.0	21.5	69.7
SMCJ14(C)A	14.0	15.60	17.90	1.0	5.0	23.2	64.7
SMCJ15(C)A*	15.0	16.70	19.20	1.0	5.0	24.4	61.5
SMCJ16(C)A	16.0	17.80	20.50	1.0	5.0	26.0	57.7
SMCJ17(C)A	17.0	18.90	21.70	1.0	5.0	27.6	53.3
SMCJ18(C)A	18.0	20.00	23.30	1.0	5.0	29.2	51.4
SMCJ20(C)A	20.0	22.20	25.50	1.0	5.0	32.4	46.3
SMCJ22(C)A	22.0	24.40	28.00	1.0	5.0	35.5	42.2
SMCJ24(C)A	24.0	26.70	30.70	1.0	5.0	38.9	38.6
SMCJ26(C)A	26.0	28.90	33.20	1.0	5.0	42.1	35.6
SMCJ28(C)A*	28.0	31.10	35.80	1.0	5.0	45.4	33.0
SMCJ30(C)A*	30.0	33.30	38.30	1.0	5.0	48.4	31.0
SMCJ33(C)A	33.0	36.70	42.20	1.0	5.0	53.3	28.1
SMCJ36(C)A*	36.0	40.00	46.00	1.0	5.0	58.1	25.8
SMCJ40(C)A	40.0	44.40	51.10	1.0	5.0	64.5	23.2
SMCJ43(C)A	43.0	47.80	54.90	1.0	5.0	69.4	21.6
SMCJ45(C)A	45.0	50.00	57.50	1.0	5.0	72.7	20.6
SMCJ48(C)A	48.0	53.30	61.30	1.0	5.0	77.4	19.4
SMCJ51(C)A	51.0	56.70	65.20	1.0	5.0	82.4	18.2
SMCJ54(C)A	54.0	60.00	69.00	1.0	5.0	87.1	17.2
SMCJ58(C)A	58.0	64.40	74.60	1.0	5.0	93.6	16.0
SMCJ60(C)A	60.0	66.70	76.70	1.0	5.0	96.8	15.5
SMCJ64(C)A	64.0	71.10	81.80	1.0	5.0	103.0	14.6
SMCJ70(C)A	70.0	77.80	89.50	1.0	5.0	113.0	13.3
SMCJ75(C)A	75.0	83.30	95.80	1.0	5.0	121.0	12.4
SMCJ78(C)A	78.0	86.70	99.70	1.0	5.0	126.0	11.4
SMCJ85(C)A	85.0	94.40	108.2	1.0	5.0	137.0	10.4
SMCJ90(C)A	90.0	100.0	115.5	1.0	5.0	146.0	10.3

1. 'C' suffix denotes bi-directional device.
2. V_{BR} measured with I_T current pulse = 300μs.
(*) Preferred Part.

Type Number ¹	V _{RWM}	V _{BR} @ I _T (Note 2)			I _R @ V _{RWM}	V _C @ I _{PP}	
		Min.	Max.	I _T	UNI- / BI-	V	A
	V	V	V	mA	μA		

1500W Transient Voltage Suppressors / SMC (Continued)



SMCJ100(C)A	100.0	111.0	128.0	1.0	5.0	162.0	9.3
SMCJ110(C)A	110.0	122.0	140.5	1.0	5.0	177.0	8.4
SMCJ120(C)A	120.0	133.0	153.0	1.0	5.0	193.0	7.9
SMCJ130(C)A	130.0	144.0	165.5	1.0	5.0	209.0	7.2
SMCJ150(C)A	150.0	167.0	192.5	1.0	5.0	243.0	6.2
SMCJ160(C)A	160.0	178.0	205.0	1.0	5.0	259.0	5.8
SMCJ170(C)A*	170.0	189.0	217.5	1.0	5.0	275.0	5.5

1500W Transient Voltage Suppressors / DO-201AD



1.5KE6.8(C)A*	5.80	6.45	7.14	10	1000/2000	10.5	143.0
1.5KE7.5(C)A*	6.40	7.13	7.88	10	500/1000	11.3	132.0
1.5KE8.2(C)A*	7.02	7.79	8.61	10	200/400	12.1	124.0
1.5KE9.1(C)A	7.78	8.65	9.55	1.0	50/100	13.4	112.0
1.5KE10(C)A*	8.55	9.50	10.50	1.0	10/20	14.5	103.0
1.5KE11(C)A	9.40	10.50	11.60	1.0	5.0	15.6	96.0
1.5KE12(C)A*	10.20	11.40	12.60	1.0	5.0	16.7	90.0
1.5KE13(C)A	11.10	12.40	13.70	1.0	5.0	18.2	82.0
1.5KE15(C)A*	12.80	14.30	15.80	1.0	5.0	21.2	71.0
1.5KE16(C)A	13.60	15.20	16.80	1.0	5.0	22.5	67.0
1.5KE18(C)A*	15.30	17.10	18.90	1.0	5.0	25.2	59.5
1.5KE20(C)A*	17.10	19.00	21.00	1.0	5.0	27.7	54.0
1.5KE22(C)A*	18.80	20.90	23.10	1.0	5.0	30.6	49.0
1.5KE24(C)A*	20.50	22.80	25.20	1.0	5.0	33.2	45.0
1.5KE27(C)A*	23.10	25.70	28.40	1.0	5.0	37.5	40.0
1.5KE30(C)A*	25.60	28.50	31.50	1.0	5.0	41.4	36.0
1.5KE33(C)A*	28.20	31.40	34.70	1.0	5.0	45.7	33.0
1.5KE36(C)A*	30.80	34.20	37.80	1.0	5.0	49.9	30.0
1.5KE39(C)A*	33.30	37.10	41.00	1.0	5.0	53.9	28.0
1.5KE43(C)A	36.80	40.90	45.20	1.0	5.0	59.3	25.3
1.5KE47(C)A	40.20	44.70	49.40	1.0	5.0	64.8	23.2
1.5KE51(C)A*	43.60	48.50	53.60	1.0	5.0	70.1	21.4
1.5KE56(C)A*	47.80	53.20	58.80	1.0	5.0	77.0	19.5
1.5KE62(C)A*	53.00	58.90	65.10	1.0	5.0	85.0	17.7
1.5KE68(C)A*	58.10	64.60	71.40	1.0	5.0	92.0	16.3
1.5KE75(C)A*	64.10	71.30	78.80	1.0	5.0	103.0	14.6
1.5KE82(C)A	70.10	77.90	86.10	1.0	5.0	113.0	13.3
1.5KE91(C)A	77.80	86.50	95.50	1.0	5.0	125.0	12.0
1.5KE100(C)A*	85.50	95.00	105.0	1.0	5.0	137.0	11.0
1.5KE110(C)A	94.00	105.0	116.0	1.0	5.0	152.0	9.9

1. 'C' suffix denotes bi-directional device.

2. Type number marking may contain a 'V' or dash in place of a decimal point.

(*) Preferred Part.

Type Number ¹	V _{RWM}	V _{BR} @ I _T (Note 2)			I _R @ V _{RWM}	V _C @ I _{PP}	
		Min.	Max.	I _T	UNI- / BI-	V	A
	V	V	V	mA	μA		

1500W Transient Voltage Suppressors / DO-201AD (Continued)



1.5KE120(C)A	102.0	114.0	126.0	1.0	5.0	165.0	9.1
1.5KE130(C)A*	111.0	124.0	137.0	1.0	5.0	179.0	8.4
1.5KE150(C)A*	128.0	143.0	158.0	1.0	5.0	207.0	7.2
1.5KE160(C)A	136.0	152.0	168.0	1.0	5.0	219.0	6.8
1.5KE170(C)A	145.0	162.0	179.0	1.0	5.0	234.0	6.4
1.5KE180(C)A	154.0	171.0	189.0	1.0	5.0	246.0	6.1
1.5KE200(C)A*	171.0	190.0	210.0	1.0	5.0	274.0	5.5
1.5KE220(C)A*	185.0	209.0	231.0	1.0	5.0	328.0	4.6
1.5KE250(C)A	214.0	237.0	263.0	1.0	5.0	344.0	5.0
1.5KE300(C)A*	256.0	285.0	315.0	1.0	5.0	414.0	5.0
1.5KE350(C)A	300.0	332.0	368.0	1.0	5.0	482.0	4.0
1.5KE400(C)A	342.0	380.0	420.0	1.0	5.0	548.0	4.0

1. 'C' suffix denotes bi-directional device.
 2. Type number marking may contain a 'V' or dash in place of a decimal point.
- (*) Preferred Part.

NPN, PNP Transistors, MOSFET

Type Number	Collector to Emitter Voltage	DC Current Gain		Saturation Voltage, Collector to Emitter		Gain Bandwidth Product	
	V_{CEO}	$h_{FE} @ V_{CEO} / I_C$		$V_{CE SAT} @ I_C / I_B$		$f_T @ V_{CE} / I_C$	
	V	Min-Max	V / mA	Max. V	mA / mA	MHz	V / mA

NPN Transistors / SOT-323 NEW



MMST2222A	40	100-300	10/150	1.0	500/50	300min	20/20
MMST3904	40	100-300	1.0/10	0.30	50/5.0	300min	20/20
MMST4401	40	100-300	1.0/150	0.75	500/50	250min	10/20

Dual NPN Transistors / SOT-363 NEW



MMDT2222A	40	100-300	10/150	1.0	500/50	300min	20/20
MMDT3904	40	100-300	1.0/10	0.30	50/5.0	300min	20/20
MMDT4401	40	100-300	1.0/150	0.75	500/50	250min	10/20

NPN Transistors / SOT-23

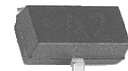

MMBT2222A	40	100-300	10/150	1.0	500/50	300min	20/20
MMBT3904	40	100-300	1.0/10	0.30	50/5	300min	20/20
MMBT4401	40	100-300	1.0/150	0.75	500/50	250min	10/20
MMBTA42 <small>NEW</small>	300	40min	10/30	0.5	20/2.0	50min	20/10
MBT5551 <small>NEW</small>	160	80-250	5.0/10	0.20	50/5.0	100-300min	10/10
MMBT4124 <small>NEW</small>	25	120-360	1.0/2.0	0.30	50/5.0	250min	20/20
MMBTA05	60	100min	1.0/100	0.25	100/10	100min	1/10
MMBTA06	80	100min	1.0/100	0.25	100/10	100min	1/10

PNP Transistors / SOT-323 NEW



MMST2907A	-60	100-300	-10/-150	-1.6	-500/-50	200min	-20/-50
MMST3906	-40	100-300	-1.0/-10	-0.40	-50/-5.0	250min	-20/-10
MMST4403	-40	100-300	-2.0-150	-0.75	-500/-50	200min	-10/-20

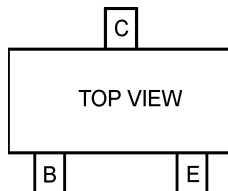

NPN/PNP TRANSISTOR
PIN CONFIGURATION
SOT-23 / SOT-323

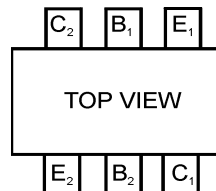

NPN/PNP TRANSISTOR
PIN CONFIGURATION
SOT-363

Type Number	Collector to Emitter Voltage	DC Current Gain		Saturation Voltage, Collector to Emitter		Gain Bandwidth Product	
	V_{CEO}	$h_{FE} @ V_{CEO} / I_C$		$V_{CE SAT} @ I_C / I_B$		$f_T @ V_{CE} / I_C$	
	V	Min-Max	V / mA	Max. V	mA / mA	MHz	V / mA

PNP Transistors / SOT-23

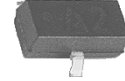

MMBT2907A	-60	100-300	-10/-150	-1.6	-500/-50	200min	-20/-50
MMBT3906	-40	100-300	-1.0/-10	-0.40	-50/-5.0	250min	-20/-10
MMBT4403	-40	100-300	-2.0/-150	-0.75	-500/-50	200min	-10/-20
MMBTA55 <small>NEW</small>	-60	100min	-1.0/-100	-0.25	-100/-10	50min	-1.0/100
MMBTA56 <small>NEW</small>	-80	100min	-1.0/-100	-0.25	-100/-10	50min	-1.0/100
MMBTA92 <small>NEW</small>	-300	40min	-10/-10	-0.50	-20/-2.0	50min	-20/-10
MMBT4126 <small>NEW</small>	-25	120-480	-1.0/-2.0	-0.40	-50/-5.0	250min	-20/-10
MMBT5401 <small>NEW</small>	-150	60-240	-5.0/-10	-0.50	-50/-5.0	100-300	-10/-10

Dual PNP Transistors / SOT-363 NEW



MMDT2907A	-60	100-300	-10/-150	-1.6	-500/-50	200min	-20/-50
MMDT3906	-40	100-300	-1.0/-10	-0.40	-50/-5.0	250min	-20/-10
MMDT4403	-40	100-300	-2.0/-150	-0.75	-500/-50	200min	-10/-20

Darlington NPN Transistors / SOT-23



MMBT6427 <small>NEW</small>	40	20,000-200,000	5.0/100	1.5	500/0.5	—	—
MMBTA13	30	10,000	5.0/100	1.5	100/0.1	125min	5/10
MMBTA14	30	20,000	5.0/100	1.5	100/0.1	125min	5/10

Darlington PNP Transistors / SOT-23 NEW

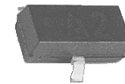

MMBTA63	-30	10,000min	-5.0/-100	-1.5	-100/-0.1	125min	-5.0/-10
MMBTA64	-30	20,000min	-5.0/-100	-1.5	-100/-0.1	125min	-5.0/-10

Complementary NPN/PNP Transistors / SOT-363 NEW





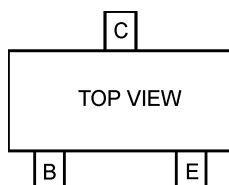

MMDT2227							
NPN Section	40	100-300	10/150	1.0	500/50	300min	20/20
PNP Section	-60	100-300	-10/-150	-1.6	-500/-50	200min	-20/-50
MMDT3946							
NPN Section	40	100-300	1.0/10	0.30	50/5.0	300min	20/20
PNP Section	-40	100-300	-1.0/-10	-0.40	-50/-5.0	250min	-20/-10
MMDT4413							
NPN Section	40	100-300	1.0/150	0.75	500/50	250min	10/20
PNP Section	-40	100-300	-2.0/-150	-0.75	-500/-50	200min	-10/-20

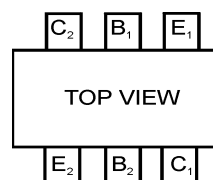

NPN/PNP TRANSISTOR
PIN CONFIGURATION
SOT-23 / SOT-323

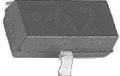

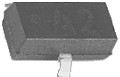
NPN/PNP TRANSISTOR
PIN CONFIGURATION
SOT-363

Type Number	V_{DSS}	V_{GSS}	$I_{D\ MAX}$	$r_{DS(on)\ max}$	Gate Threshold Voltage $V_{GS\ TA}$	I_{DSS}	C_{ISS}
N-Channel MOSFET / SOT-23 <i>NEW</i>							
2N7002	60V	$\pm 20\ V$	115mA	7.5Ohm	2.5Vmax	1.0 μ A	50pF
MMBF170	60V	$\pm 20\ V$	500mA	5.0Ohm	3.0Vmax	1.0 μ A	40pF
BS870	60V	$\pm 20\ V$	250mA	5.0Ohm	3.0Vmax	0.5 μ A	50pF
N-Channel MOSFET / SOT-323 <i>NEW</i>							
2N7002W	60V	$\pm 20\ V$	115mA	7.5Ohm	2.5Vmax	1.0 μ A	50pF
N-Channel MOSFET / SC-59 <i>NEW</i>							
DMN100	30V	$\pm 20\ V$	$\pm 1.1A$	0.17Ohm	3.0Vmax	1.0 μ A	150pF
Dual N-Channel MOSFET / SOT-363 <i>NEW</i>							
2N7002DW	60V	$\pm 20\ V$	115mA	7.5Ohm	2.5Vmax	1.0 μ A	50pF

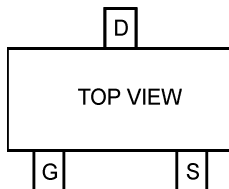

N-CHANNEL MOSFET
PIN CONFIGURATION
SOT-23 / SOT-323 / SC-59

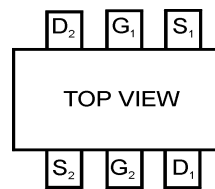

DUAL N-CHANNEL MOSFET
PIN CONFIGURATION
SOT-363

Product Packaging Information

Package Outline Dimensions

All Dimensions in mm

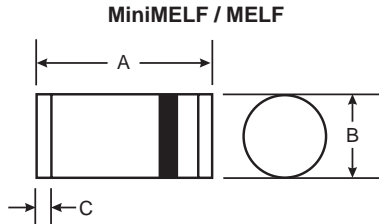

Dim	MiniMELF		MELF	
	Min	Max	Min	Max
A	3.30	3.70	4.80	5.20
B	1.30	1.60	2.40	2.60
C	0.28	0.50	0.55 Nominal	

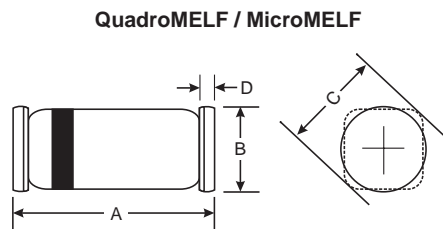

Dim	QuadroMELF		MicroMELF	
	Min	Max	Min	Max
A	3.3	3.7	1.8	2.0
B	1.4	1.6	1.20	1.25
C	1.7 \varnothing Typical		1.35 \varnothing Typical	
D	0.3 Typical		—	

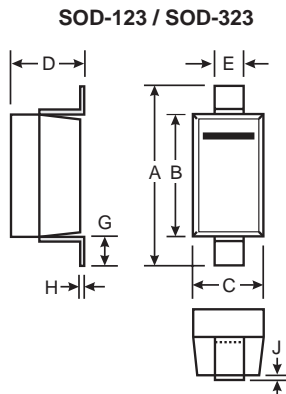

Dim	SOD-123		SOD-323	
	Min	Max	Min	Max
A	3.55	3.85	2.30	2.70
B	2.55	2.85	1.60	1.80
C	1.40	1.70	1.15	1.35
D	—	1.35	0.80	1.10
E	0.55 Typical		0.25	0.40
G	0.25	—	0.15	0.45
H	0.15 Typical		0.10	0.25
J	—	0.10	—	0.10

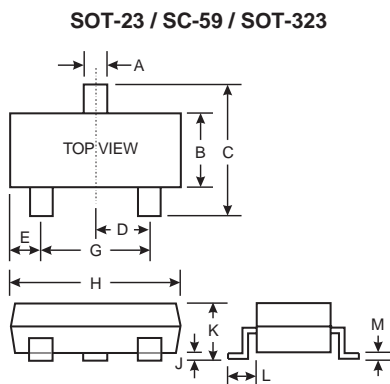

Dim	SOT-23		SC-59		SOT-323	
	Min	Max	Min	Max	Min	Max
A	0.37	0.51	0.30	0.50	0.30	0.40
B	1.19	1.40	1.40	1.80	1.15	1.35
C	2.10	2.50	2.50	3.00	2.00	2.20
D	0.89	1.05	0.85	1.05	0.65 Nominal	
E	0.45	0.61	0.30	0.70	0.30	0.40
G	1.78	2.05	1.70	2.10	1.20	1.40
H	2.65	3.05	2.70	3.10	1.80	2.20
J	0.013	0.15	—	0.10	0.0	0.10
K	0.89	1.10	1.00	1.40	0.90	1.00
L	0.45	0.61	0.55	0.70	0.25	0.40
M	0.076	0.178	0.10	0.35	0.10	0.25

SOT-363

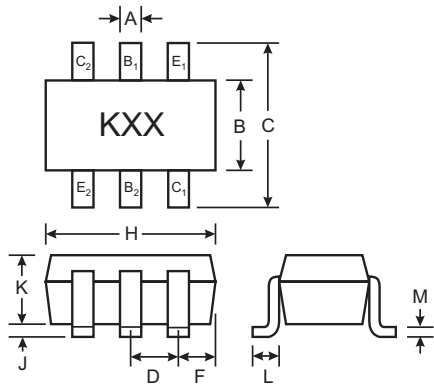

SOT-363		
Dim	Min	Max
A	0.10	0.30
B	1.15	1.35
C	2.00	2.20
D	0.65 Nominal	
F	0.30	0.40
H	1.80	2.20
J	—	0.10
K	0.90	1.00
L	0.25	0.40
M	0.10	0.25

SMA, SMB, SMC

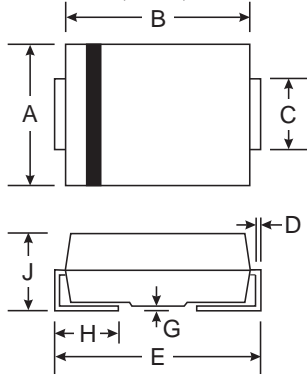

Dim	SMA		SMB		SMC	
	Min	Max	Min	Max	Min	Max
A	2.29	2.92	3.30	3.94	5.59	6.22
B	4.00	4.60	4.06	4.57	6.60	7.11
C	1.27	1.63	1.96	2.21	2.75	3.18
D	0.15	0.31	0.15	0.31	0.15	0.31
E	4.80	5.59	5.00	5.59	7.75	8.13
G	0.10	0.20	0.10	0.20	0.10	0.20
H	0.76	1.52	0.76	1.52	0.76	1.52
J	2.01	2.62	2.00	2.62	2.00	2.62

DF-S / MiniDIP

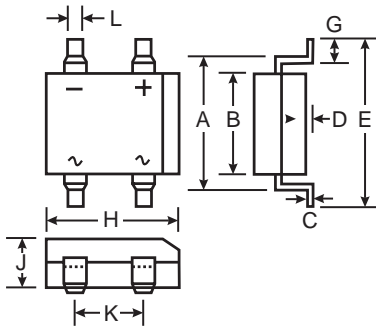

Dim	DF-S		MiniDIP		DF-M	
	Min	Max	Min	Max	Min	Max
A	7.40	7.90	5.43	5.75	7.40	7.90
B	6.20	6.50	3.6	4.0	6.20	6.50
C	0.22	0.30	0.15	0.35	0.22	0.30
D	0.076	0.33	0.05	0.20	1.27	2.03
E	—	10.40	—	7.0	7.60	8.90
G	1.02	1.53	0.70	1.10	3.81	4.69
H	8.13	8.51	4.5	4.9	8.13	8.51
J	2.40	3.40	2.8	2.9	2.40	3.40
K	5.00	5.20	2.5	2.7	5.00	5.20
L	1.00	1.20	0.50	0.80	0.46	0.58

DF-M

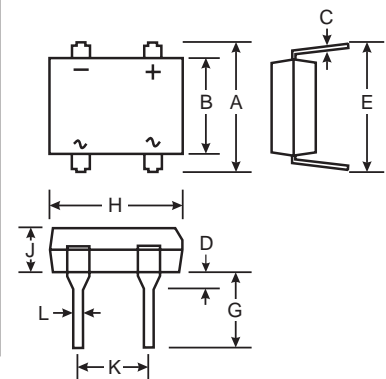

TO-220AC

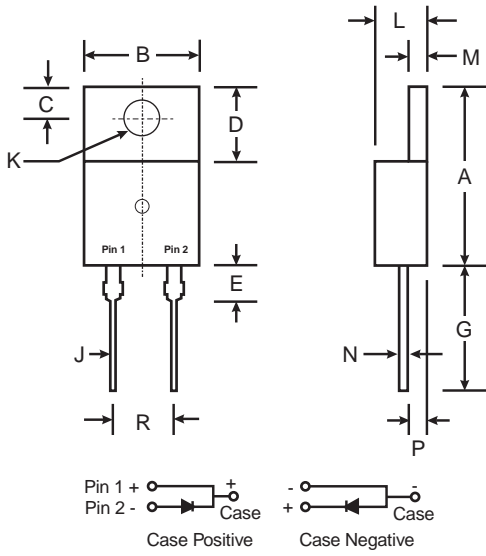

Dim	Min	Max
A	14.22	15.88
B	9.65	10.67
C	2.54	3.43
D	5.84	6.86
E	—	6.35
G	12.70	14.73
H	2.29	2.79
J	0.51	1.14
K	3.53 \varnothing	4.09 \varnothing
L	3.56	4.83
M	1.14	1.40
N	0.30	0.64
P	2.03	2.92
R	4.83	5.33

TO-220AB

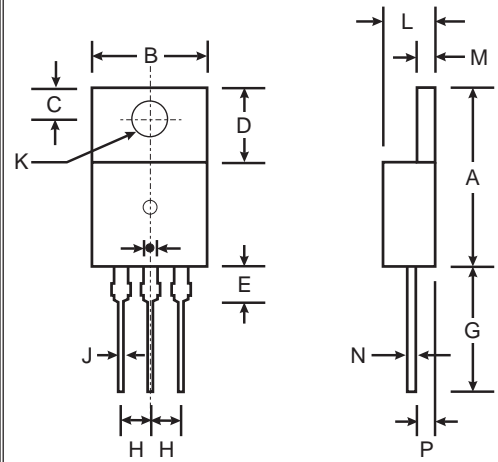

D²PAK

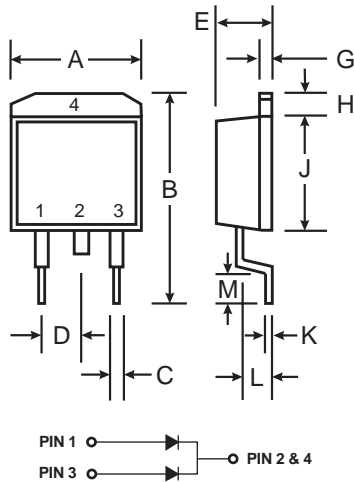

Dim	Min	Max
A	9.65	10.69
B	14.60	15.88
C	0.51	1.14
D	2.29	2.79
E	4.37	4.83
G	1.14	1.40
H	1.14	1.40
J	8.25	9.25
K	0.30	0.64
L	2.03	2.92
M	2.29	2.79

TO-3P

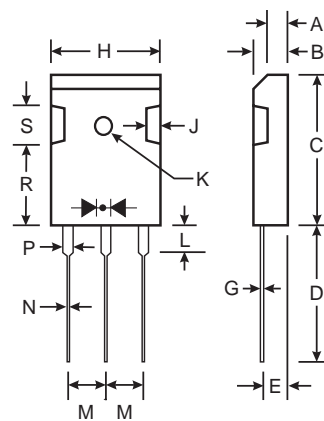

Dim	Min	Max
A	3.20	3.50
B	4.59	5.16
C	20.80	21.30
D	19.70	20.20
E	2.10	2.40
G	0.51	0.76
H	15.90	16.40
J	1.70	2.70
K	3.10 \varnothing	3.30 \varnothing
L	3.50	4.51
M	5.20	5.70
N	1.12	1.22
P	2.90	3.30
R	11.70	12.80
S	4.30 Typical	

Axial Devices (Through-Hole)

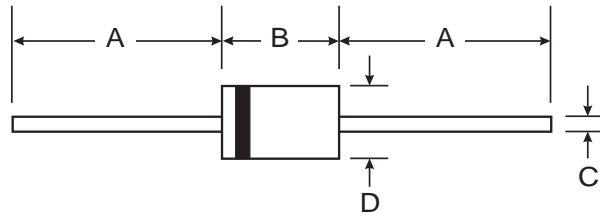

Dim	A		B		C		D	
	Min	Max	Min	Max	Min	Max	Min	Max
A-405	25.40	—	4.10	5.20	0.53	0.64	2.00	2.70
DO-35	25.40	—	—	4.00	—	0.60	—	2.00
DO-41 Plastic	25.40	—	4.06	5.21	0.71	0.864	2.00	2.72
DO-41 Glass	25.40	—	—	4.70	—	0.863	—	2.71
DO-15	25.40	—	5.50	7.62	0.686	0.889	2.60	3.60
DO-201	25.40	—	8.50	9.53	0.96	1.06	4.80	5.21
DO-201AD	25.40	—	7.20	9.50	1.20	1.30	4.80	5.30
R-6	25.40	—	8.60	9.10	1.20	1.30	8.60	9.10
T-1	25.40	—	2.60	3.20	0.53	0.64	2.20	2.60
5W	25.40	—	8.38	8.89	0.94	1.09	3.30	3.68
5KP	25.40	—	—	8.60	0.95	1.07	—	9.53
5KW	25.40	—	—	9.00	1.20	1.30	—	8.00

TO-92

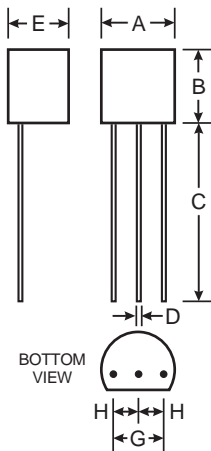

Dim	Min	Max
A	4.32	4.83
B	4.32	4.78
C	12.50	15.62
D	0.36	0.56
E	3.15	3.94
G	2.29	2.79
H	1.14	1.40

Lead configuration shown is for bulk product packaging only.
See ANSI/EIA-486 for Radial Tape specifications.

WOG

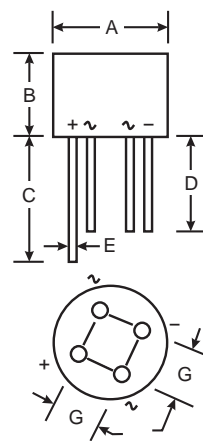

Dim	Min	Max
A	8.84	9.86
B	4.00	4.60
C	27.90	—
D	25.40	—
E	0.71	0.81
G	4.60	5.60

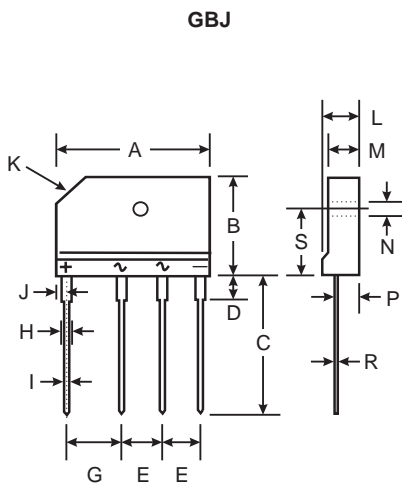

Dim	Min	Max
A	29.70	30.30
B	19.70	20.30
C	17.00	18.00
D	3.80	4.20
E	7.30	7.70
G	9.80	10.20
H	2.00	2.40
I	0.90	1.10
J	2.30	2.70
K	3.0 X 45°	
L	4.40	4.80
M	3.40	3.80
N	3.10	3.40
P	2.50	2.90
R	0.60	0.80
S	10.80	11.20

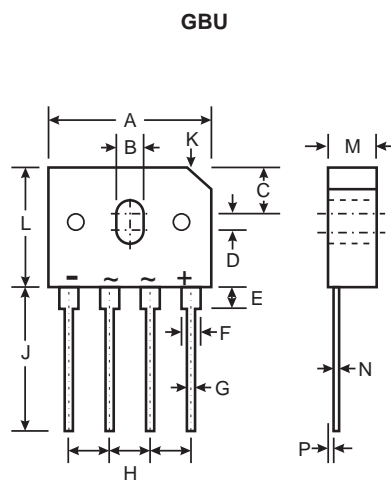

GBU		
Dim	Min	Max
A	21.8	22.3
B	3.5	4.1
C	7.4	7.9
D	1.65	2.16
E	2.25	2.75
G	1.02	1.27
H	4.83	5.33
J	17.5	18.0
K	3.2 X 45°	
L	18.3	18.8
M	3.30	3.56
N	0.46	0.56
P	0.76	1.0

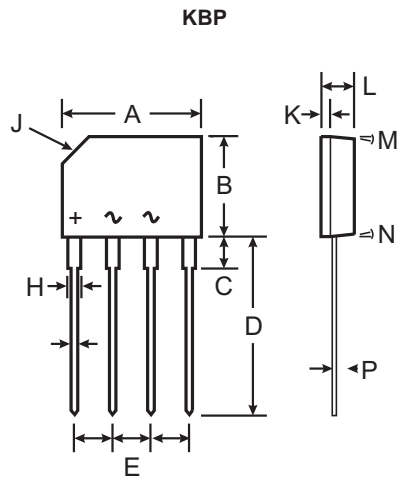

Dim	Min	Max
A	14.25	14.75
B	10.20	10.60
C	2.29 Typical	
D	14.25	14.73
E	3.56	0.86
G	0.76	0.86
H	1.17	1.42
J	2.8 X 45° Chamfer	
K	0.80	1.10
L	3.35	3.65
M	3° Nominal	
N	2° Nominal	
P	0.30	0.64

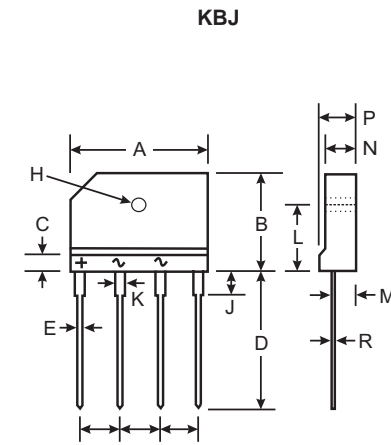

Dim	Min	Max
A	24.80	25.20
B	14.70	15.30
C	4.00 Nominal	
D	17.20	17.80
E	0.90	1.10
G	7.30	7.70
H	3.10 \varnothing	3.40 \varnothing
J	3.30	3.70
K	1.50	1.90
L	9.30	9.70
M	2.50	2.90
N	3.40	3.80
P	4.40	4.80
R	0.60	0.80

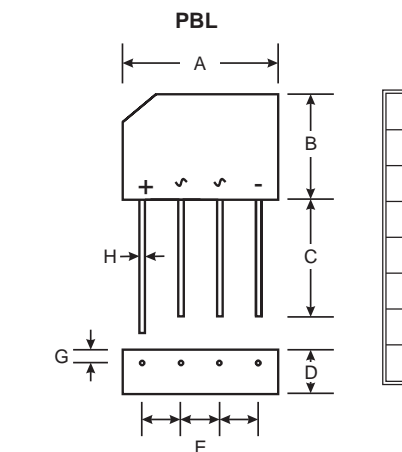

Dim	Min	Max
A	18.50	19.50
B	15.40	16.40
C	19.00	—
D	6.20	6.50
E	4.60	5.60
G	1.50	2.00
H	1.30 Typical	

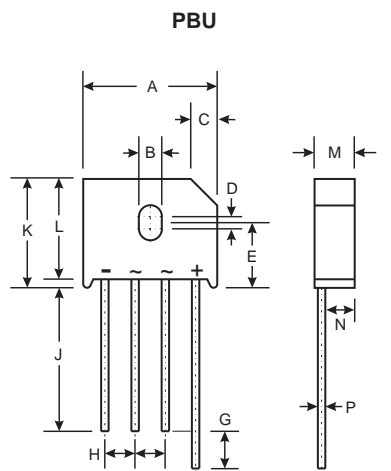

Dim	Min	Max
A	22.70	23.70
B	3.80	4.10
C	4.20	4.70
D	1.70	2.20
E	10.30	11.30
G	4.50	6.80
H	4.80	5.80
J	25.40	—
K	—	19.30
L	16.80	17.80
M	6.60	7.10
N	4.70	5.20
P	1.20	1.30

PBPC-3

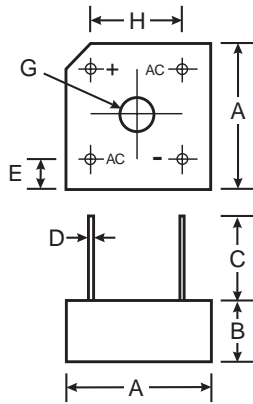

Dim	Min	Max
A	14.73	15.75
B	5.84	6.86
C	19.00	—
D	0.76Ø Typical	
E	1.70	2.70
G	Hole for #6 screw	
	3.60	4.00
H	10.30	11.30

PBPC-8

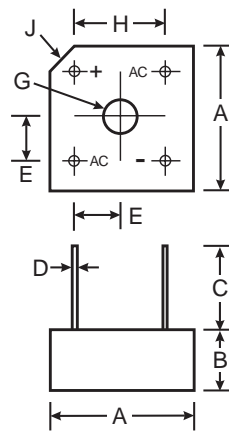

Dim	Min	Max
A	18.54	19.56
B	6.35	7.60
C	22.20	—
D	1.27Ø Typical	
E	5.33	7.37
G	3.60Ø	4.00Ø
H	12.70 Typical	
J	2.38 X 45° Typical	

MP / GBPC

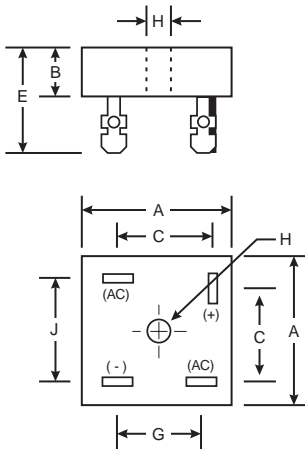

Dim	Min	Max
A	28.30	28.80
B	7.40	8.00
C	16.10	17.10
E	18.80	21.30
G	13.80	14.80
H	Hole for #10 screw	
	4.85Ø	5.59Ø
J	17.60	18.60
K	10.90	11.90
L	0.97Ø	1.07Ø
M	26.4	—
N	7.40	8.00
P	17.60	18.60

MP-W / GBPC-W

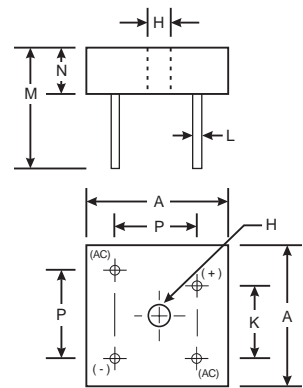

MB / KBPC

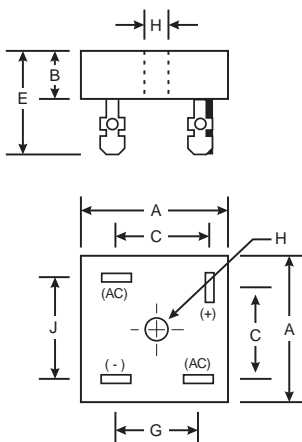

Dim	Min	Max
A	28.40	28.70
B	10.97	11.23
C	15.50	17.60
E	22.86	25.40
G	13.30	15.30
H	Hole for #10 screw	
	4.85Ø	5.59Ø
J	17.10	19.10
K	10.40	12.40
L	0.97Ø Nominal	
M	30.50	—
N	10.97	11.23
P	17.10	19.10

MB-W / KBPC-W

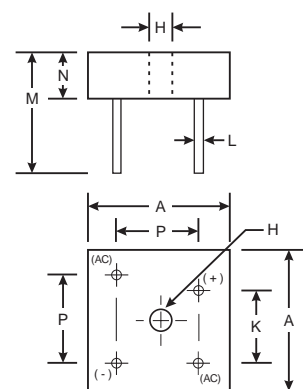

Suggested Pad Layout

Based on IPC-SM-782

Figure 1 Dimensions	MicroMELF	MiniMELF QuadroMELF	MELF	SOD-323	SOD-123	SMA	SMB	SMC
Z	3.0	4.8	6.3	3.75	4.9	6.6	6.7	9.3
G	1.4	2.1	3.3	1.05	2.5	1.5	1.8	4.4
X	1.5	1.7	2.7	0.65	0.7	1.7	2.3	3.3
Y	0.8 ref.	1.3 ref.	1.5 ref.	1.35ref.	1.2 ref.	2.6 ref.	2.5 ref.	2.5 ref.

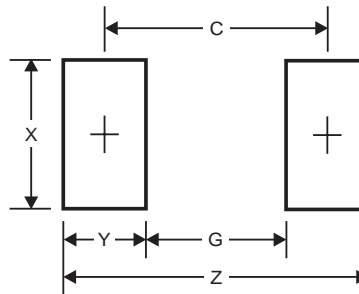

Fig. 1

Figure 2 Dimensions	SOT-323	SOT-23	SC-59
Z	3.0	3.4	4.0
G	0.6	0.7	1.2
X	0.8	0.9	0.9
Y	1.2ref.	1.4 ref.	1.4ref.
C	1.2ref.	2.0 ref.	2.6ref

Figure 3 Dimensions	SOT-363
Z	2.5
G	1.3
X	0.42
Y	0.6ref.
C	1.9ref.

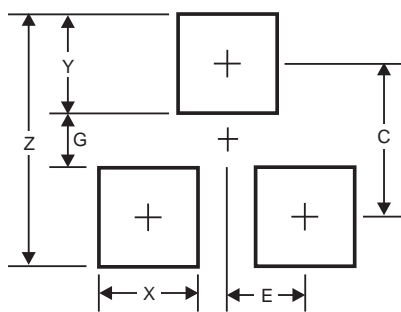

Fig. 2

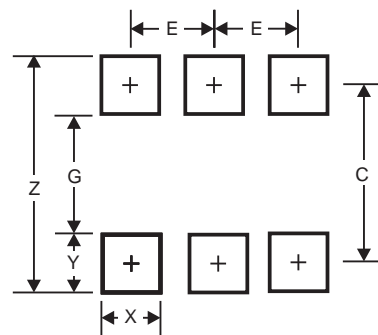

Fig. 3

ALL DIMENSIONS ARE NOMINAL VALUES SHOWN IN MILLIMETERS

Note: The suggested land pattern dimensions have been provided for reference only, as actual pad layout may vary depending on application. These numbers may be modified based on user equipment capability or fabrication criteria. A more robust pattern may be desired for wave soldering and is calculated by adding 0.2 mm to the 'Z' dimension. For further information, please reference document IPC-SM-782, Surface Mount Design and Land Pattern Standard, and for International grid details, please see document IEC, Publication 97.

Figure 4 Dimensions	MiniDIP	DF-S
Z	8.1	11.5
G	4.4	6.9
X	0.9	1.3
Y	1.9 ref.	2.3 ref.
C	6.3 ref.	9.2 ref.

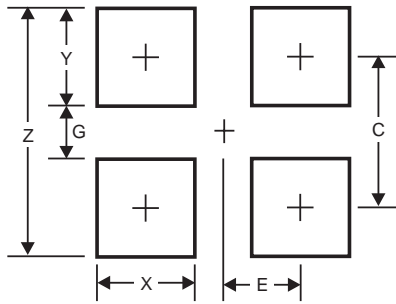

Fig. 4

Figure 5 Dimensions	D ² PAK
Z	16.9
X1	1.1
X2	10.8
Y1	3.5
Y2	11.4
C	9.5 ref.
E1	2.5 ref.

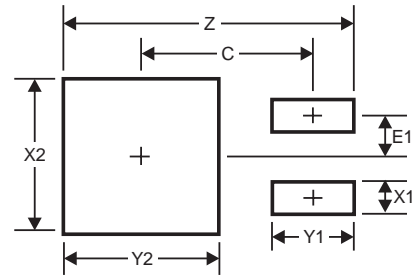

Fig. 5

ALL DIMENSIONS ARE NOMINAL VALUES SHOWN IN MILLIMETERS

Note: The suggested land pattern dimensions have been provided for reference only, as actual pad layout may vary depending on application. These numbers may be modified based on user equipment capability or fabrication criteria. A more robust pattern may be desired for wave soldering and is calculated by adding 0.2 mm to the 'Z' dimension. For further information, please reference document IPC-SM-782, Surface Mount Design and Land Pattern Standard, and for International grid details, please see document IEC, Publication 97.

Surface Mount (SMD) Packaging

Reel and Courier Tape Specifications

MINIMUM PACKING QUANTITY			
PACKAGE TYPE	Bulk Tube Quantity	Tape and Reel 7"Ø Quantity ("R")	Tape and Reel 13"Ø Quantity ("T")
SOT-23/323/363	NA	3K	NA
SOD-123/323	NA	3K	NA
MicroMELF	NA	2.5K	10K
QuadroMELF	NA	2.5K	10K
MiniMELF	NA	2.5K	10K
MELF	NA	NA	5K
SMA	NA	1.5K	5K
SMB	NA	500	3K
SMC	NA	NA	3K
DF-S	50	NA	1.5K
D ² PAK	NA	NA	800

Note: Package quantities are for minimum packaging quantity only, not minimum order quantity. For minimum order quantity, please consult the Sales Department.

Tape Dimensions and Orientation: (Dimensions in mm)

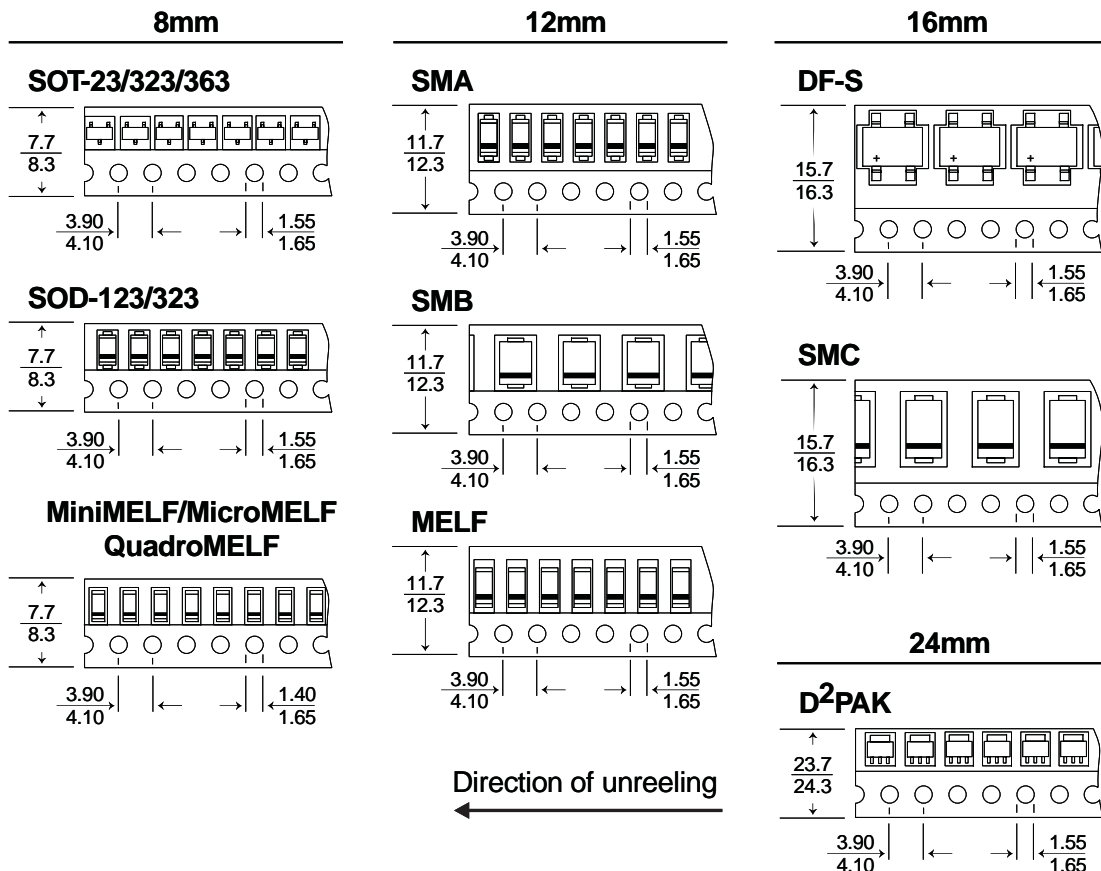

EMBOSED CARRIER TAPE SPECIFICATIONS

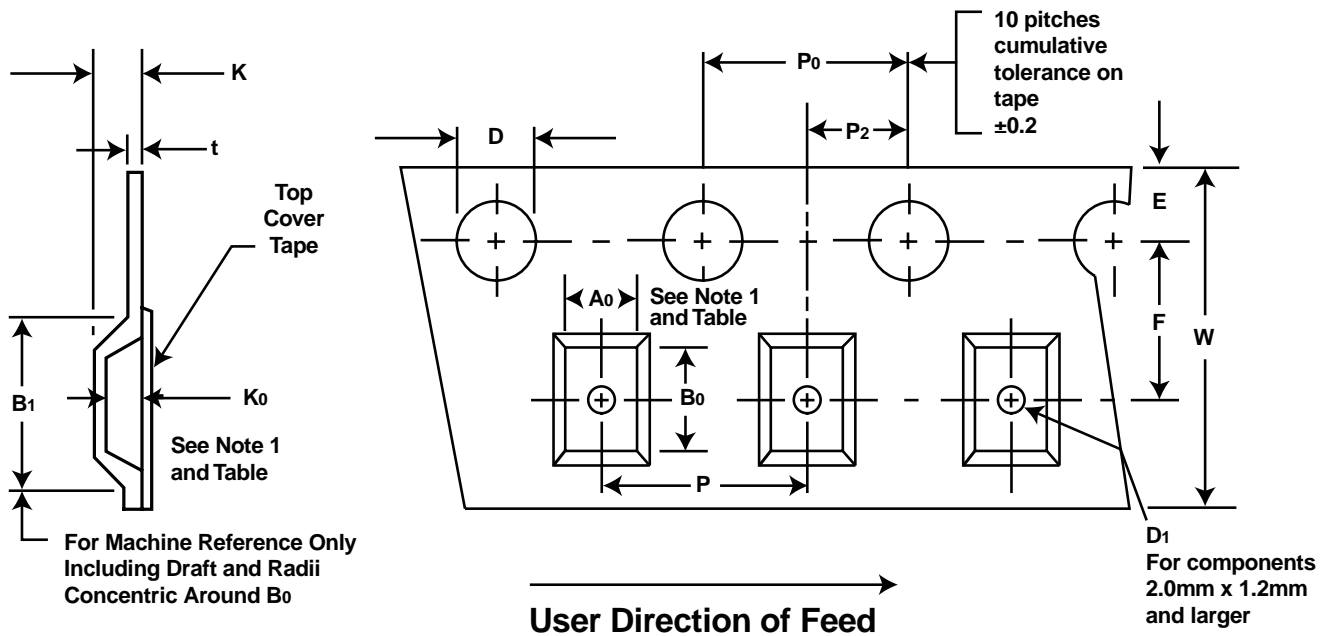

(8, 12, 16, 24mm Tape)

8, 12, 16, 24mm EMBOSED TAPE DIMENSIONS IN mm						
Tape Size	D	E	P_0	t_{max}	$A_0 B_0 K_0$	Constant Dimensions
8, 12, 16, 24mm	$1.55^{+0.10}_{-0.0}$	1.75 ± 0.10	4.0 ± 0.10	0.400	See Note 1	

Tape Size	B_1 max	D_1 min	F	K max	P_2	R min	W	Product Type
8mm	4.5	1.0	3.5 ± 0.05	2.4	2.0 ± 0.05	25	8.0 ± 0.30	SOT-23, MiniMELF, SOD-123, MicroMELF, QuadromELF
12mm	8.2	1.5	5.5 ± 0.05	4.5	2.0 ± 0.05	30	12.0 ± 0.30	MELF, SMA, SMB
16mm	12.1	1.5	7.5 ± 0.10	3.29 3.70	2.0 ± 0.10 4.0 ± 0.10	40	16.0 ± 0.30	SMC DF-S
24mm	20.1	1.5	11.5 ± 0.10	6.5	2.0 ± 0.10	50	24.0 ± 0.30	D ² PAK

Tape Size	P			
	4.0 ± 0.10	8.0 ± 0.10	12.0 ± 0.10	16.0 ± 0.10
8mm	X	—	—	—
12mm	X	X	—	—
16mm	—	X	X	—
24mm	—	—	—	X

- Notes:
- $A_0 B_0 K_0$ are determined by component size. The clearance between the component and the cavity must be within 0.05mm min. to 0.50mm max. for 8mm tape, 0.05mm min. to 0.65 mm max. for 12mm tape and 0.15mm min. to 0.90mm max. for 16mm tape. Add 0.05mm min. to 1.00mm min. for 24mm tape and larger. The component cannot rotate more than 20° within the determined cavity, see sketch next page.
 - Tape and components shall pass around radius 'R' without damage.

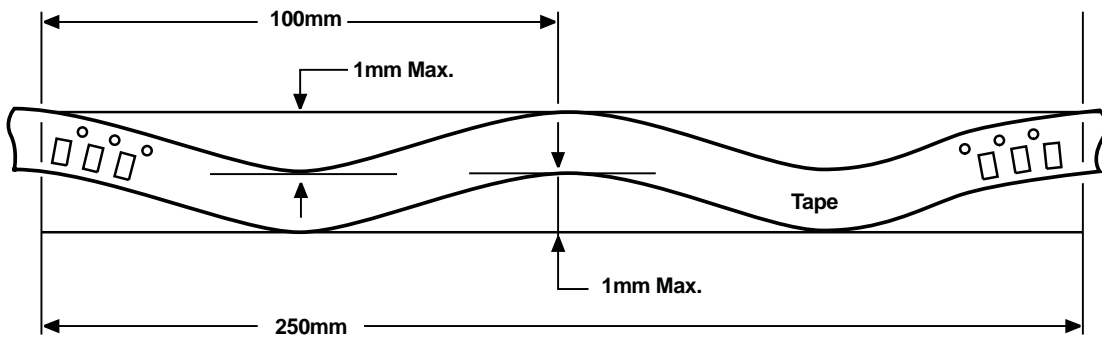
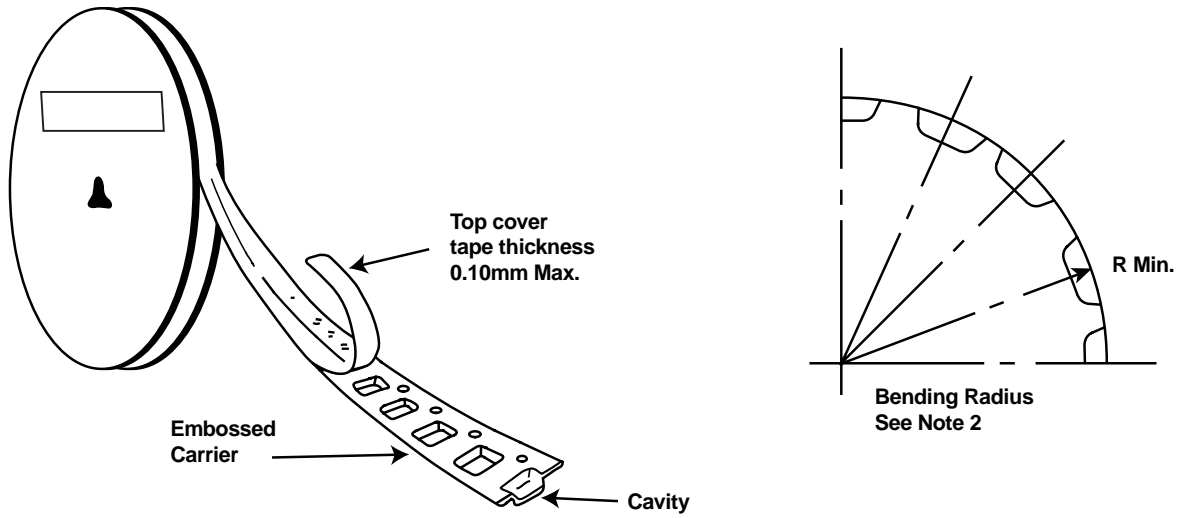

Camber (Top View)

Allowable camber to be 1.0mm/100mm non-accumulative over 250mm

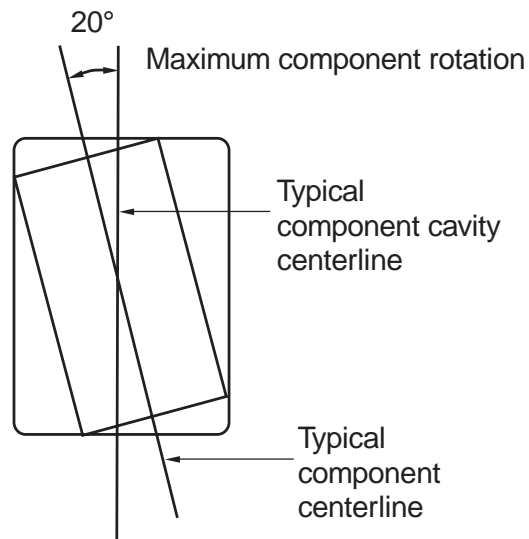

SURFACE MOUNT CARRIER TAPE SPECIFICATIONS SURFACE MOUNT REEL SPECIFICATIONS

(All Dimensions in mm)

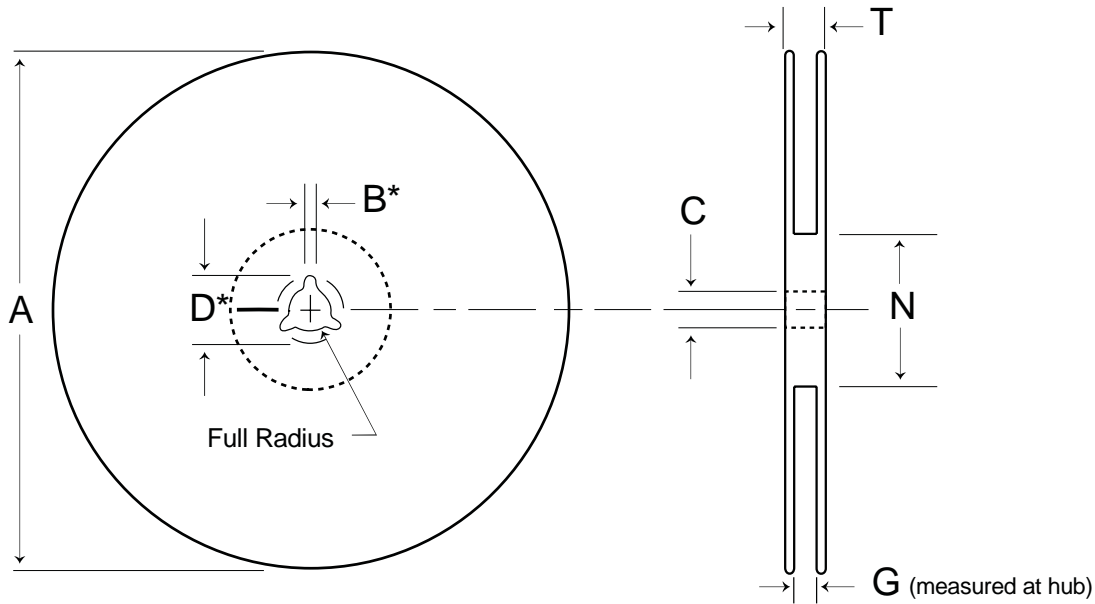

* Drive spokes optional. If used, dimensions with asterisks apply.

Tape Size	A Max	B* Max	C	D* Max	N Min	G	T Max
8mm	330	1.5	13.0 ± 0.20	20.2	50	8.4 ^{+1.5} _{-0.0}	14.4
12mm	330	1.5	13.0 ± 0.20	20.2	50	12.4 ^{+2.0} _{-0.0}	18.4
16mm	330	1.5	13.0 ± 0.20	20.2	50	16.4 ^{+2.0} _{-0.0}	22.4
24mm	330	1.5	13.0 ± 0.20	20.2	50	24.4 ^{+2.0} _{-0.0}	30.4

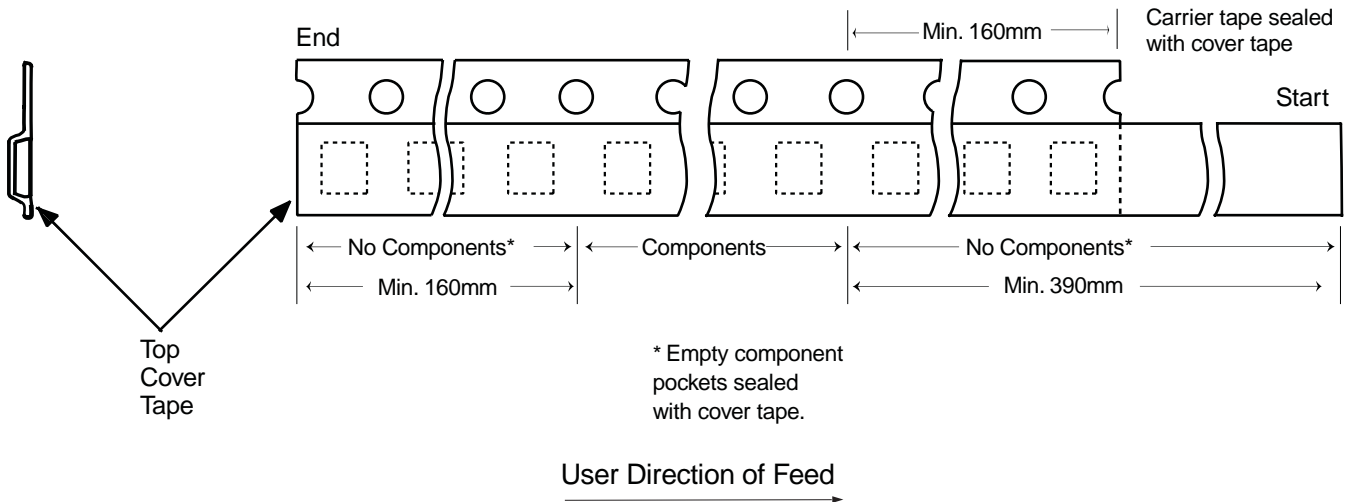

Tape Leader and Trailer

Through-hole Packaging

Reels, Ammo Packs, & Taping Specifications

MINIMUM PACKAGING QUANTITY

MINIMUM PACKING QUANTITY					
Device Type	Available Packaging				
	Bulk			13"Ø Tape & Reel	Ammo Pack
	Quantity per Box	Quantity per Tube	Quantity per Tray	Quantity per Reel	Quantity per Box
5KP	500			500 / 700*	
5W	1K			3K	
5KW				1K	
A-405	1K			5K	3K
DF-M	5K	50			
DO-15	500 / 800 / 1K*			4K	2K
DO-201	1K			1K / 1.2K*	1K
DO-201AD	500 / 1K*			1.2K	1K
DO-35	500			10K	5K / 10K*
DO-41	500 / 1K*			5K	3K / 5K*
GBJ	750	15			
GBPC/W			100		
GBU	1K	20			
KBJ	1K	20			
KBP	3.5K	35			
KBPC/W			100		
MB/W			100		
MP/W			100		
PBL			100		
PBPC-3			200		
PBPC-8	150				
PBU			100		
R-6	200 / 500*			500 / 700*	
T-1	1K			5K	3K
TO-220AB/AC	2K	50			
TO-3P	1.2K	30			
TO-92	2K / 5K*				2K / 4K*
WOG	1K				

* Quantity varies by Part Number.

Note: Package quantities given are for minimum packing quantity only, not minimum order quantity. For minimum order quantity, please consult the Sales Department.

PRODUCT REEL DIMENSIONS/SPECIFICATIONS

PRODUCT REEL					
Description	Symbol	Specification		Alternate	
		Inches	Millimeters	Inches	Millimeters
Arbor Hole Diameter	D_0	0.65 ± 0.02	16.6 ± 0.50	1.18 ± 0.02	30.0 ± 0.50
Core Diameter (O.D.)	D_1	3.2 Typical	81.0 Typical	3.2 Typical	81.0 Typical
Reel Diameter	D_2	13.6 ± 0.6	345.0 ± 15.0	10.25 ± 0.6	260.0 ± 15.0
Drive Hole Diameter	D_3	0.38 ± 0.02	9.5 ± 0.5	0.38 ± 0.02	9.5 ± 0.5
Material Thickness	W_0	0.08 – 0.16	2.0 – 4.0	0.08 – 0.16	2.0 – 4.0
Reel Width	W_1	3.15 ± 0.20	80.0 ± 5.0	2.56 ± 0.20	65.0 ± 5.0
Drive/Arbor Hole Spacing	W_2	1.08 ± 0.02	27.5 ± 0.5	1.08 ± 0.02	27.5 ± 0.5

Core material: plastic (blue/black) or metal (neutral)
 Reel material: corrugated board or plastic (blue or black)
 For label dimensions and placement see AP02006.

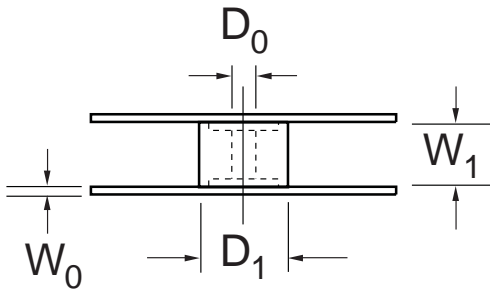

Direction of Unreeling

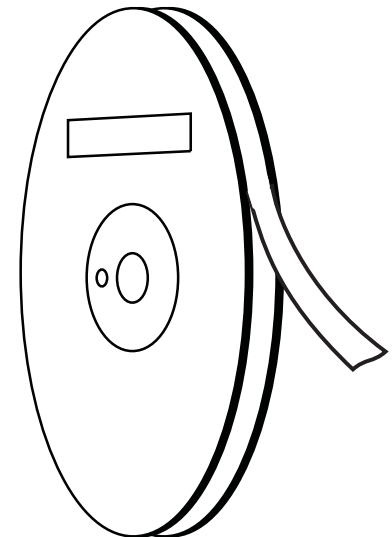
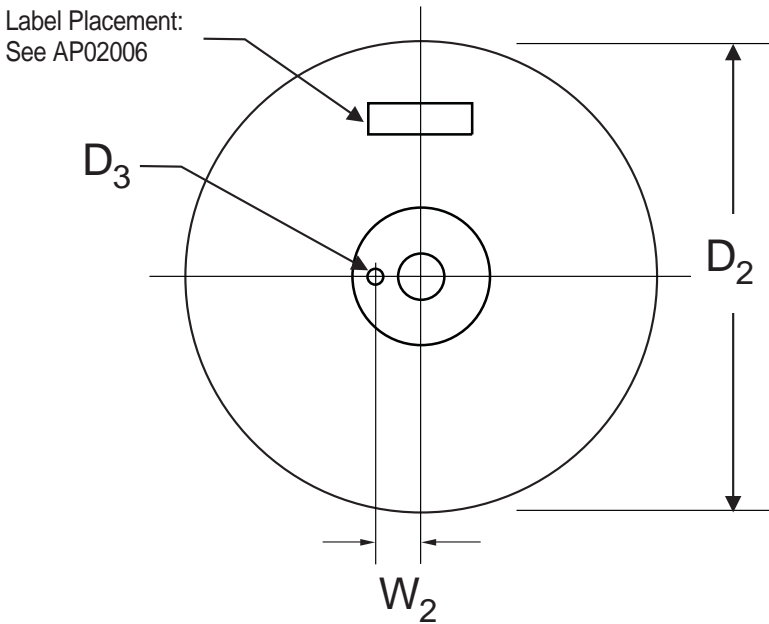

REEL/AMMO PACK TAPING SPECIFICATIONS

REEL AND AMMO PACK TAPING SPECIFICATIONS			
Description	Symbol	Body	Specification (mm)
Component Pitch	A	DO-15, DO-35, DO-41, A-405, 5W	5.0 ± 0.5
		DO-201, DO-201AD, 5KP, 5KW, R-6	10.0 ± 0.5
Inside Tape Spacing	B	All	52.4 ± 1.5
Lead to Lead Eccentricity	$ D_1 - D_2 $	All	1.4 max
Lead Extension	K	All	0.8 max
Lead Bending	M	All	1.2 max
Cumulative Pitch	P	All	2.0 per 10 pitch
Exposed Adhesive	S	All	0.8 max
Tape Width	T	All	6.0 ± 0.4
Tape Leader	Beginning and end of reel or ammo pack		300.0 min
Empty Spaces	Consecutive missing components not allowed		< 0.1%
Polarity Marking	All polarized components shall be oriented in the same direction. The cathode tape shall be colored, and the anode tape shall be white or light beige. Anode end must face label-side of reel. See AP02006 for label placement.		

Dimensions A, M, K, P,
S, & T apply to both sides

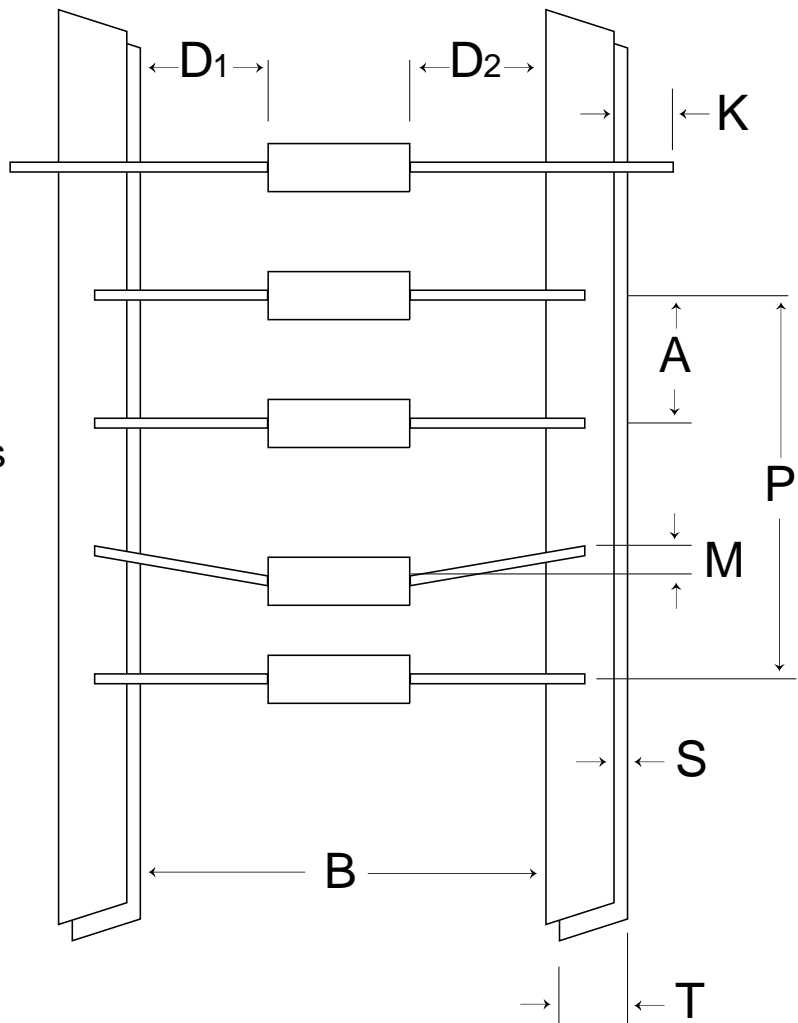

AMMO PACK DIMENSIONS/SPECIFICATIONS

AMMO PACK						
PRODUCT DESCRIPTION	HEIGHT (H)		WIDTH (W)		LENGTH (L)	
	inches	mm	inches	mm	inches	mm
DO-35, DO-41 Glass Case	4.88	124	3.00	75	10.00	255
DO-41 Plastic Case	5.75	145	3.12	79	10.25	260
TO-92	TBA	TBA	TBA	TBA	TBA	TBA

Material: corrugated board (neutral)
 Thickness: $3.00 \pm 0.5\text{mm}$ ($0.12 \pm 0.02"$)
 For label dimensions and placement see AP02006.

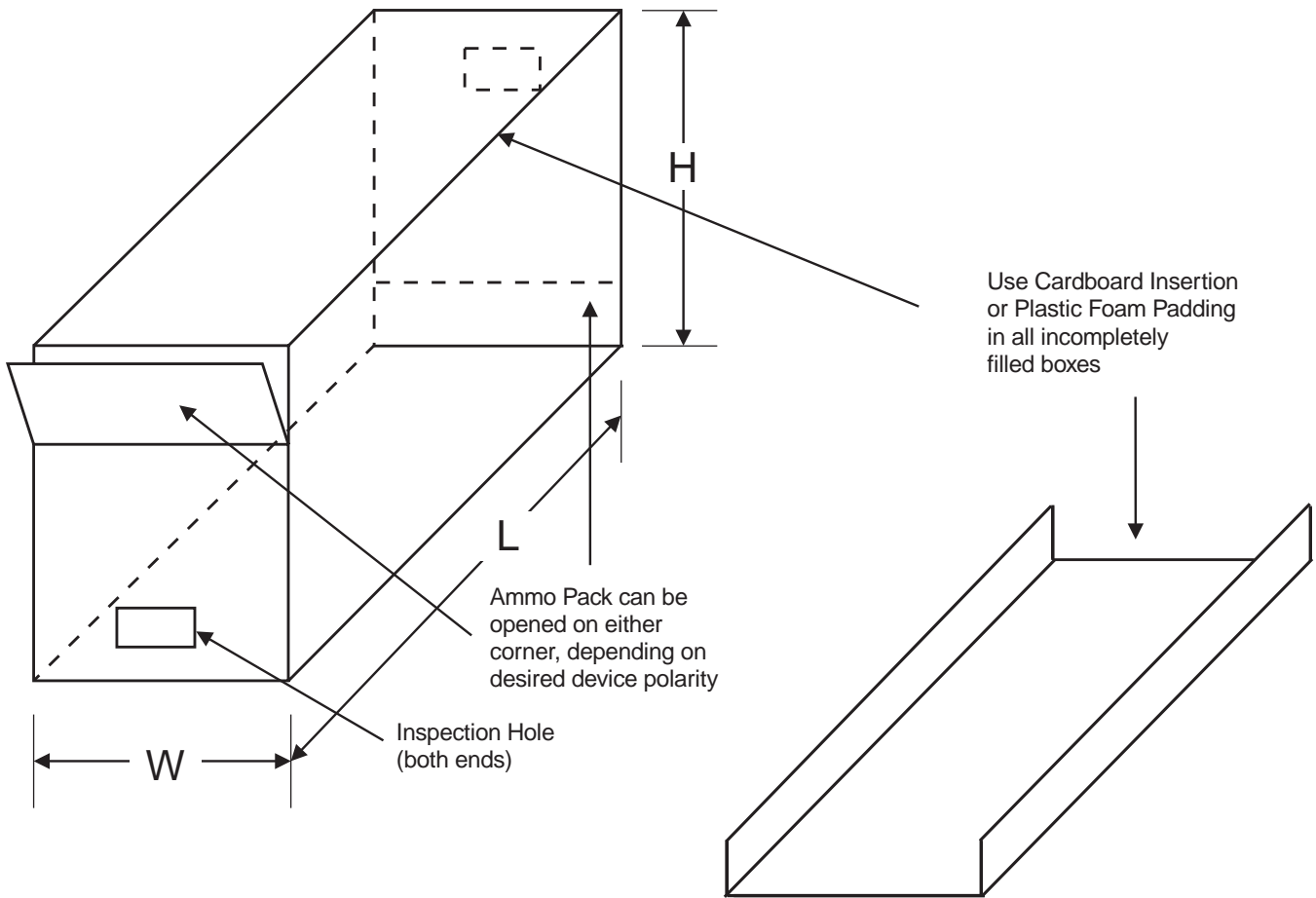

Product Label Specification

Label Placement/Dimensions, Definitions, & Part Designation

STANDARD PRODUCT LABEL

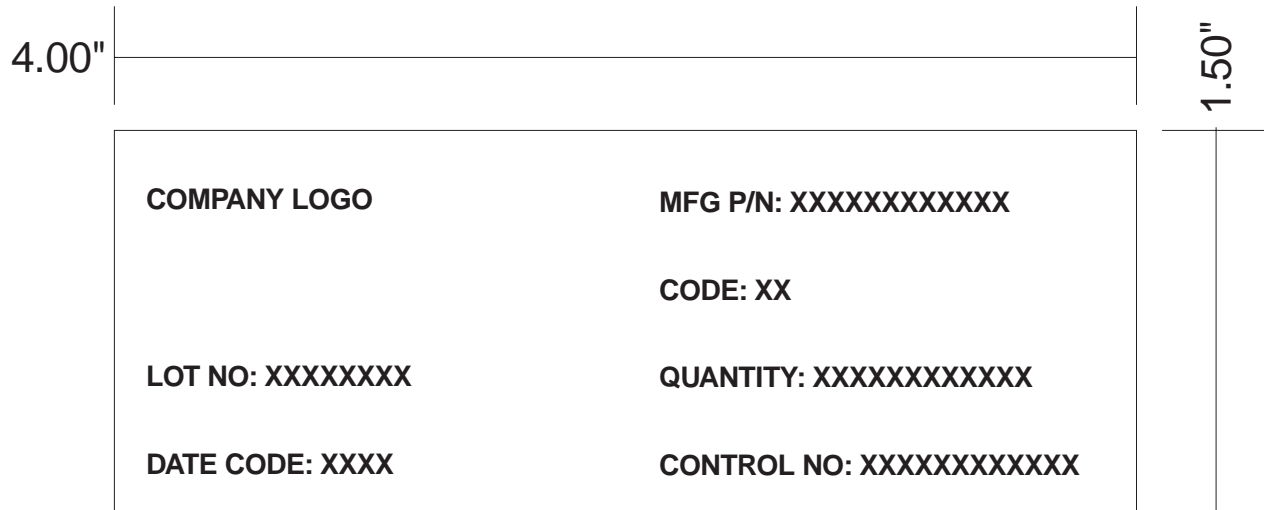

PRODUCT LABEL FIELD FORMAT AND CODES INFORMATION		
LABEL FIELD	FORMAT/MAX LENGTH	CONTENTS
LOT NO	8 Digit / Alphanumeric	Contains the lot number of the wafer used to build the parts in the package (individual manufacturing plant format is acceptable.)
DATE CODE	4 Digit / Numeric	Contains the first 2 digits for the year and the last 2 digits for the week of the year when product was manufactured.
MFG P/N	12 Digit / Alphanumeric	Contains the part number assigned by Diodes Inc. The suffix indicates the type of packaging that the parts are in.
CODE	2 Digit / Alphanumeric	Contains the manufacturing plant code assigned by Diodes Inc.
QUANTITY	12 Digit / Numeric	Contains the quantity in the reel or box that the label is attached to.
CONTROL NO.	12 Digit / Alphanumeric	Contains information about operator, equipment used and work time or shift the parts were manufactured (individual manufacturing plant format is acceptable.)

1. Product Labels must be affixed to all product reels, trays, and inner boxes.
2. Product Labels must follow the format outlined in this specification.
3. Labels may be printed by any means or technology including, but not limited to, dot matrix, thermal transfer, laser, or ink jet printing.
4. See AP02005 for carton dimensions/specifications.
5. All product will be periodically inspected for conformance to this specification.
6. Logo and all printing in black only.

PART NUMBER DESCRIPTION

The table below shows Part Number components and provides the meaning of each suffix that may be used.

PART NUMBER DESCRIPTION			
EXAMPLE	GENERIC P/N	SUFFIX	DESIGNATION
1N4004-T	1N4004	T	Tape and Reel (Axial)
1N5401-B	1N5401	B	Bulk/Tray
LL4148-7	LL4148	7	7" Reel (SMD)
BAV20-13	BAV20	13	13" Reel
1N4728A-A	1N4728A	A	Ammo Box
KBJ401G	KBJ401G		Tube

1. All references to parts/product must be in accordance to the above designations.

LABEL PLACEMENT

1. All product labels must be placed per this specification.
2. Bar Code label placement for both inner and outer cartons are per Bar Code Specification.
3. 7" reels require a bar code label only.
4. Label placement for 7" and 13" reels are per Figure 1 of this specification.
5. Label placement for Ammo Packs are per Figure 2 of this specification.
6. Product Labels must be affixed to all product reels, trays, ammo packs, and inner boxes.
7. All product will be periodically inspected for conformance to this specification.

7" AND 13" REEL LABEL PLACEMENT - FIGURE 1

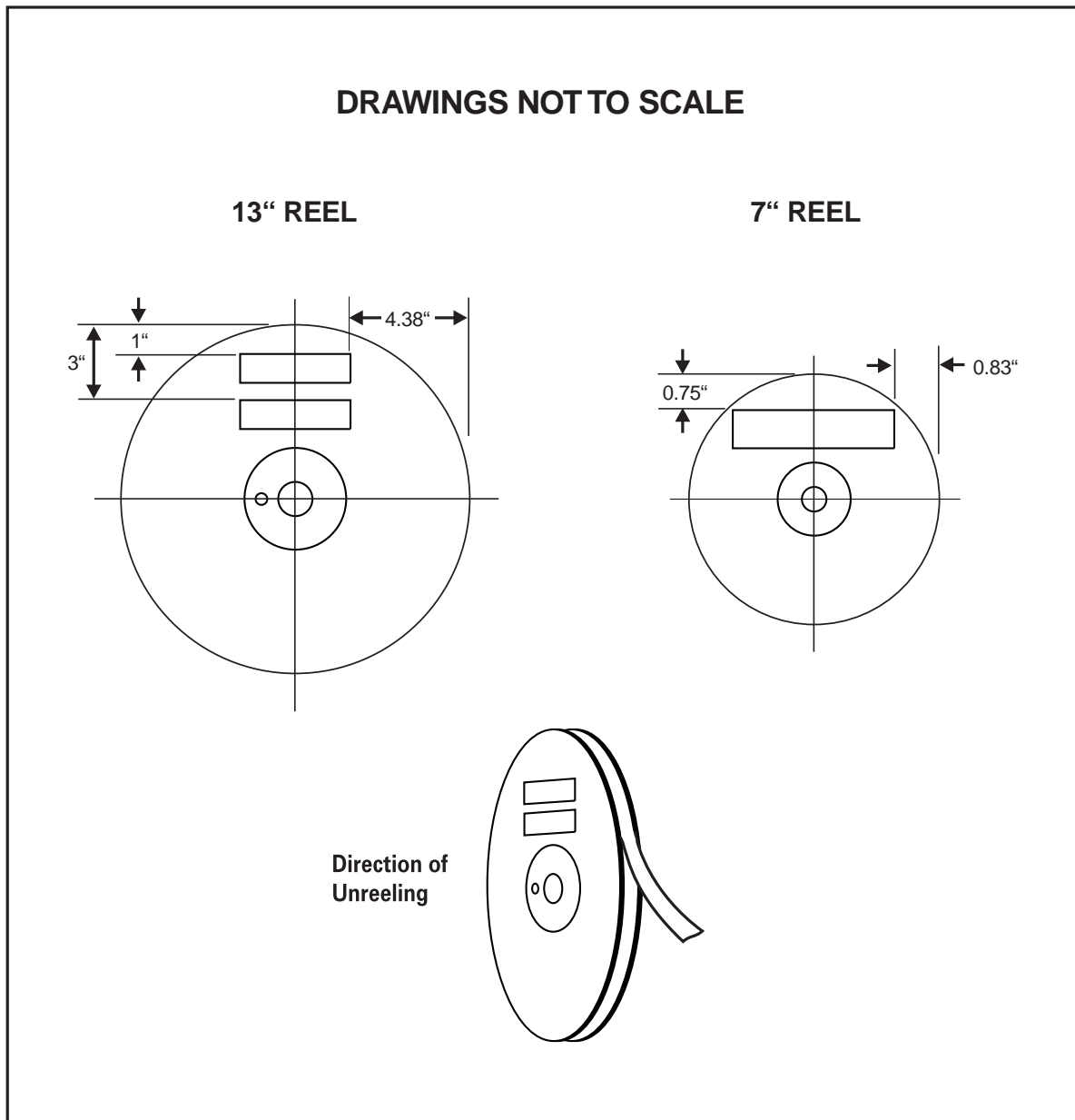

1. All product labels must be clearly legible and shall be placed per this specification.
2. Labels shall be affixed to the top portion of each reel. Text shall be readable.
3. 7" reels shall include only a Bar Code label.
4. 13" reels shall contain both a Standard Product Label and a Bar Code Label. The bar code label shall be placed below the standard label.
5. All products will be periodically inspected for conformance to this specification.

AMMO PACK LABEL PLACEMENT - FIGURE 2

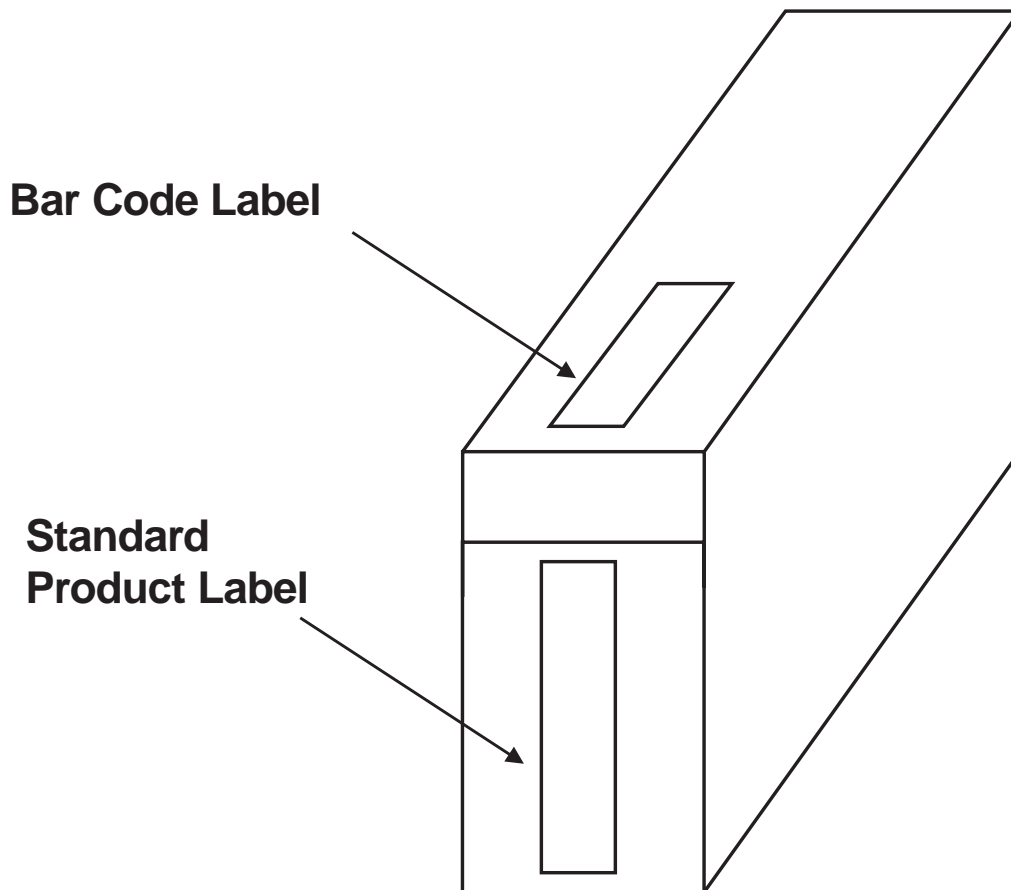

1. Standard Product Labels shall be affixed to the front side of ammo pack.
2. Bar Code Labels shall be affixed to the top of the ammo pack, 1" from front carton edge.
3. Labels will be centered between carton edges and may NOT cover carton openings.
4. Top of readable text shall be toward left side of carton.
5. All product labels must be placed per this specification.
6. All products will be periodically inspected for conformance to this specification.

Product Carton Specification

Outer/Inner Cartons, Designs

OUTER CARTON SPECIFICATIONS

OUTER CARTON								
PRODUCT DESCRIPTION	HEIGHT (H)		WIDTH (W)		LENGTH (L)		CARTON TYPE	MAX QTY
	inches	mm	inches	mm	inches	mm		
SMA, SMB	13.38	340	13.75	350	13.38	340	A	TBA
SMC	16.50	420	13.75	350	13.38	340	A	TBA
D ² PAK	14.25	360	13.75	350	13.75	350	A	TBA
TO-3P	10.50	265	9.00	230	22.63	575	B	TBA
TO-220AB, TO-220AC	8.50	215	14.00	355	22.63	575	B	TBA
DF-M	12.50	315	13.00	330	19.75	500	B	TBA
DF-S	13.38	340	13.75	350	13.75	350	A	TBA
DO-15, DO-41, A-405 Bulk	9.88	250	8.25	210	17.75	450	B	TBA
DO-201AD, R6 Bulk	11.00	280	13.00	330	13.50	342	A	TBA
5KP, 5KW, 5W, DO-15, DO-41, DO-201AD, R6, T1 Tape and Reel	13.38	340	13.38	340	13.38	340	A	TBA
RS4, PBL	12.08	315	11.38	290	13.00	330	A	TBA
R2, PBP	11.75	300	13.00	330	13.00	330	A	TBA
RS6, PBU	11.75	300	13.00	330	13.00	330	A	TBA
PBPC-3/6A	11.75	300	13.00	330	13.00	330	A	TBA
PCPC-8/10A	12.25	310	8.25	210	17.75	450	B	TBA
KBPC, GBPC, MP, MB	8.25	210	11.38	290	13.00	330	A	TBA
WOG	11.38	290	13.12	333	14.25	363	A	TBA
KBJ	9.63	245	9.06	230	22.44	570	B	TBA
GBJ	10.38	265	9.06	230	20.50	520	B	TBA
KBP	11.25	285	10.38	265	22.44	570	B	TBA
TO-92	9.00	230	14.00	355	14.00	355	A	TBA
SOT-23	8.00	203	18.00	457	18.00	457	B	TBA

1. All cartons must meet Rule 41 of the Uniform Freight Classification.
2. All carton printing must be from supplied camera ready art. Utilize figures 1-4 of this specification.
3. Printed carton color must be Black.
4. Dimension tolerance is ± 0.20 " or ± 5.0 mm.
5. General carton design types A and B must be followed. Due to varying carton shapes, it may be necessary to scale or reposition design elements to match general format.
6. Inner and Outer carton must be affixed with Bar Code Labels as outlined in QP-086.
7. Carton samples or layout must be submitted to Quality Assurance prior to first article shipment.
8. Product Packaging will periodically be inspected for compliance to this specification.

INNER CARTON SPECIFICATIONS

INNER CARTON						
PRODUCT DESCRIPTION	HEIGHT (H)		WIDTH (W)		LENGTH (L)	
	inches	mm	inches	mm	inches	mm
SMC - Top	2.05	52	13.25	335	13.25	335
SMC - Bottom	2.00	50	13.00	330	13.00	330
D ² PAK - Top	1.50	38	13.25	335	13.25	335
D ² PAK - Bottom	1.45	37	13.00	330	13.00	330
TO-3P	4.75	120	7.88	200	21.63	550
TO-220AB, TO-220AC	3.75	95	6.50	165	21.88	555
DO-15, DO-41, A-405 Bulk	0.75	20	3.38	84	7.75	198
DO-201AD, R6 Bulk	1.50	38	3.25	76	11.88	302
PCPC-8/10A - Top	2.25	55	8.06	205	8.06	205
PCPC-8/10A - Bottom	2.06	53	7.88	200	7.88	200
KBPC, GBPC, MP, MB	0.56	15	12.63	280	12.63	320
WOG - Top	2.63	67	6.81	173	9.75	246
WOG - Bottom	2.56	65	6.50	165	9.56	243
KBJ	0.38	110	0.75	200	21.63	550
GBJ	4.75	120	0.75	200	19.75	500
KBP	5.12	130	9.25	235	21.63	550

1. All cartons must meet Rule 41 of the Uniform Freight Classification.
2. Dimension tolerance is ± 0.20 " or ± 5.0 mm.
3. Inner and Outer carton must be affixed with Bar Code Labels as outlined in QP-086.
4. Product Packaging will periodically be inspected for compliance to this specification.

Index

- 1.5KE10(C)A, 10-7
1.5KE100(C)A, 10-7
1.5KE11(C)A, 10-7
1.5KE110(C)A, 10-7
1.5KE12(C)A, 10-7
1.5KE120(C)A, 10-8
1.5KE13(C)A, 10-7
1.5KE130(C)A, 10-8
1.5KE15(C)A, 10-7
1.5KE150(C)A, 10-8
1.5KE16(C)A, 10-7
1.5KE160(C)A, 10-8
1.5KE170(C)A, 10-8
1.5KE18(C)A, 10-7
1.5KE180(C)A, 10-8
1.5KE20(C)A, 10-7
1.5KE200(C)A, 10-8
1.5KE22(C)A, 10-7
1.5KE220(C)A, 10-8
1.5KE24(C)A, 10-7
1.5KE250(C)A, 10-8
1.5KE27(C)A, 10-7
1.5KE30(C)A, 10-7
1.5KE300(C)A, 10-8
1.5KE33(C)A, 10-7
1.5KE350(C)A, 10-8
1.5KE36(C)A, 10-7
1.5KE39(C)A, 10-7
1.5KE400(C)A, 10-8
1.5KE43(C)A, 10-7
1.5KE47(C)A, 10-7
1.5KE51(C)A, 10-7
1.5KE56(C)A, 10-7
1.5KE6.8(C)A, 10-7
1.5KE62(C)A, 10-7
1.5KE68(C)A, 10-7
1.5KE7.5(C)A, 10-7
1.5KE75(C)A, 10-7
1.5KE8.2(C)A, 10-7
1.5KE82(C)A, 10-7
1.5KE9.1(C)A, 10-7
1.5KE91(C)A, 10-7
1N4001, 7-2
1N4001G, 7-2
1N4001GL, 7-2
1N4001L, 7-2
1N4002, 7-2
1N4002G, 7-2
1N4002GL, 7-2
1N4002L, 7-2
1N4003, 7-2
1N4003G, 7-2
1N4003GL, 7-2
1N4003L, 7-2
1N4004, 7-2
1N4004G, 7-2
1N4004GL, 7-2
1N4004L, 7-2
1N4005, 7-2
1N4005G, 7-2
1N4005GL, 7-2
1N4005L, 7-2
1N4006, 7-2
1N4006G, 7-2
1N4006GL, 7-2
1N4006L, 7-2
1N4007, 7-2
1N4007G, 7-2
1N4007GL, 7-2
1N4007L, 7-2
1N4148, 4-3
1N4148W, 4-2
1N4148WS, 4-2
1N4150, 4-3
1N4151, 4-3
1N4154, 4-3
1N4448, 4-3
1N4448W, 4-2
1N4448WS, 4-2
1N4728A, 9-26
1N4729A, 9-26
1N4730A, 9-26
1N4731A, 9-26
1N4732A, 9-26
1N4733A, 9-26
1N4734A, 9-26
1N4735A, 9-26
1N4736A, 9-26
1N4737A, 9-26
1N4738A, 9-26
1N4739A, 9-26
1N4740A, 9-26
1N4741A, 9-26
1N4742A, 9-26
1N4743A, 9-26
1N4744A, 9-26
1N4745A, 9-26
1N4746A, 9-26
1N4747A, 9-26
1N4748A, 9-26
1N4749A, 9-26
1N4750A, 9-26
1N4751A, 9-26
1N4752A, 9-26
1N4753A, 9-26
1N4754A, 9-26
1N4755A, 9-26
1N4756A, 9-26
1N4757A, 9-26
1N4758A, 9-26
1N4759A, 9-26
1N4760A, 9-26
1N4761A, 9-26
1N4933, 6-2
1N4933G, 6-2
1N4933GL, 6-3
1N4933L, 6-2
1N4934, 6-2
1N4934G, 6-2
1N4934GL, 6-3
1N4934L, 6-2
1N4935, 6-2
1N4935G, 6-2
1N4935GL, 6-3
1N4935L, 6-2
1N4936, 6-2
1N4936G, 6-2
1N4936GL, 6-3
1N4936L, 6-2
1N4937, 6-2
1N4937G, 6-2
1N4937GL, 6-3
1N4937L, 6-2
1N5221B, 9-22
1N5222B, 9-22
1N5223B, 9-22
1N5224B, 9-22
1N5225B, 9-22
1N5226B, 9-22
1N5227B, 9-22
1N5228B, 9-22
1N5229B, 9-22
1N5230B, 9-22
1N5231B, 9-22
1N5232B, 9-22
1N5233B, 9-22
1N5234B, 9-22
1N5235B, 9-22
1N5236B, 9-22
1N5237B, 9-22
1N5238B, 9-22
1N5239B, 9-22
1N5240B, 9-22
1N5241B, 9-22
1N5242B, 9-22
1N5243B, 9-22
1N5244B, 9-22
1N5245B, 9-22
1N5246B, 9-22
1N5247B, 9-22
1N5248B, 9-22
1N5249B, 9-22
1N5250B, 9-22
1N5251B, 9-22
1N5252B, 9-22
1N5253B, 9-22
1N5254B, 9-22
1N5255B, 9-22
1N5256B, 9-22
1N5257B, 9-22
1N5258B, 9-23
1N5259B, 9-23
1N5260B, 9-23
1N5261B, 9-23
1N5262B, 9-23
1N5263B, 9-23
1N5264B, 9-23
1N5265B, 9-23
1N5266B, 9-23
1N5267B, 9-23
1N5391, 7-3
1N5391S, 7-3
1N5392, 7-3
1N5392S, 7-3
1N5393, 7-3
1N5393S, 7-3
1N5395, 7-3
1N5395S, 7-3
1N5397, 7-3
1N5397S, 7-3
1N5398, 7-3
1N5398S, 7-3
1N5399, 7-3
1N5399S, 7-3
1N5400, 7-5
1N5400G, 7-5
1N5401, 7-5
1N5401G, 7-5
1N5402, 7-5
1N5402G, 7-5
1N5403G, 7-5
1N5404, 7-5
1N5404G, 7-5
1N5405G, 7-5
1N5406, 7-5
1N5406G, 7-5
1N5407, 7-5
1N5407G, 7-5
1N5408, 7-5
1N5408G, 7-5
1N5711, 2-3
1N5711W, 2-1
1N5711WS, 2-1
1N5817, 3-2
1N5817M, 3-1
1N5818, 3-2
1N5818M, 3-1
1N5819, 3-2
1N5819M, 3-1
1N5820, 3-3
1N5821, 3-3
1N5822, 3-3
1N6263, 2-3
1N6263W, 2-3
2N7002, 11-3
2N7002DW, 11-3
2N7002W, 11-3
2W005G, 8-2
2W01G, 8-2
2W02G, 8-2
2W04G, 8-2
2W06G, 8-2
2W08G, 8-2
2W10G, 8-2
- A**
AZ23C10, 9-1
AZ23C11, 9-1
AZ23C12, 9-1
AZ23C13, 9-1
AZ23C15, 9-1
AZ23C16, 9-1
AZ23C18, 9-1
AZ23C20, 9-1
AZ23C22, 9-1
AZ23C24, 9-1
AZ23C27, 9-1
AZ23C2V7, 9-1
AZ23C30, 9-1
AZ23C33, 9-1
AZ23C36, 9-1
AZ23C39, 9-1
AZ23C3V0, 9-1
AZ23C3V3, 9-1
AZ23C3V6, 9-1
AZ23C3V9, 9-1
AZ23C43, 9-1
AZ23C47, 9-1
AZ23C4V3, 9-1
AZ23C4V7, 9-1
AZ23C51, 9-1
AZ23C5V1, 9-1
AZ23C5V6, 9-1
AZ23C6V2, 9-1
AZ23C6V8, 9-1
AZ23C7V5, 9-1
AZ23C8V2, 9-1
AZ23C9V1, 9-1
- B**
B0520LW, 3-1
B0520W, 3-1
B0530W, 3-1
B0540W, 3-1
B1100, 3-1
B1100B, 3-1
B1100LB, 3-1
B120, 3-1
B120B, 3-1
B130, 3-1
B130B, 3-1
B130LB, 3-1
B140, 3-1
B140B, 3-1
B150, 3-1
B150B, 3-1
B160, 3-1
B160B, 3-1
B170, 3-1
B170B, 3-1
B180, 3-1
B180B, 3-1
B190, 3-1
B190B, 3-1
B2100, 3-2
B220, 3-2
B220A, 3-2
B230, 3-2
B230A, 3-2
B240, 3-2
B240A, 3-2
B250, 3-2
B250A, 3-2
B260, 3-2
B260A, 3-2
B270, 3-2
B280, 3-2
B290, 3-2
B3100, 3-3
B320, 3-3
B320A, 3-2
B320B, 3-2
B330, 3-3
B330A, 3-2
B330B, 3-2
B340, 3-3
B340A, 3-2
B340B, 3-2

B350, 3-3	BAV20, 4-3	BZM5266B, 9-14	BZT52C33, 9-10	BZT55C68, 9-16
B350A, 3-2	BAV201, 4-2	BZM5267B, 9-14	BZT52C33S, 9-5	BZT55C6V2, 9-16
B350B, 3-2	BAV202, 4-2	BZM55C10, 9-15	BZT52C36, 9-10	BZT55C6V8, 9-16
B360, 3-3	BAV203, 4-2	BZM55C11, 9-15	BZT52C36S, 9-5	BZT55C75, 9-16
B360A, 3-2	BAV20W, 4-2	BZM55C12, 9-15	BZT52C39, 9-10	BZT55C7V5, 9-16
B360B, 3-2	BAV20WS, 4-2	BZM55C13, 9-15	BZT52C39S, 9-5	BZT55C8V2, 9-16
B370, 3-3	BAV21, 4-3	BZM55C15, 9-15	BZT52C3V0, 9-10	BZT55C9V1, 9-16
B380, 3-3	BAV21W, 4-2	BZM55C16, 9-15	BZT52C3V0S, 9-5	BZX55C10, 9-24
B390, 3-3	BAV21WS, 4-2	BZM55C18, 9-15	BZT52C3V3, 9-10	BZX55C11, 9-24
B520C, 3-3	BAV23S, 4-1	BZM55C20, 9-15	BZT52C3V3S, 9-5	BZX55C12, 9-24
B530C, 3-3	BAV301, 4-2	BZM55C22, 9-15	BZT52C3V6, 9-10	BZX55C13, 9-24
B540C, 3-3	BAV302, 4-2	BZM55C24, 9-15	BZT52C3V6S, 9-5	BZX55C15, 9-24
B550C, 3-3	BAV303, 4-2	BZM55C27, 9-15	BZT52C3V9, 9-10	BZX55C16, 9-24
B560C, 3-3	BAV70, 4-1	BZM55C2V4, 9-15	BZT52C3V9S, 9-5	BZX55C18, 9-24
BAL99, 4-1	BAV70W, 4-1	BZM55C2V7, 9-15	BZT52C43, 9-10	BZX55C20, 9-24
BAS16, 4-1	BAV99, 4-1	BZM55C30, 9-15	BZT52C47, 9-10	BZX55C22, 9-24
BAS16W, 4-1	BAV99W, 4-1	BZM55C33, 9-15	BZT52C4V3, 9-10	BZX55C24, 9-24
BAS19, 4-1	BAW56, 4-1	BZM55C36, 9-15	BZT52C4V3S, 9-5	BZX55C27, 9-24
BAS19W, 4-1	BAW56W, 4-1	BZM55C39, 9-15	BZT52C4V7, 9-10	BZX55C2V4, 9-24
BAS20, 4-1	BS870, 11-3	BZM55C3V0, 9-15	BZT52C4V7S, 9-5	BZX55C2V7, 9-24
BAS20W, 4-1	BZM44C68, 9-15	BZM55C3V3, 9-15	BZT52C51, 9-10	BZX55C30, 9-24
BAS21, 4-1	BZM5221B, 9-13	BZM55C3V6, 9-15	BZT52C5V1, 9-10	BZX55C33, 9-24
BAS21W, 4-1	BZM5222B, 9-13	BZM55C3V9, 9-15	BZT52C5V1S, 9-5	BZX55C36, 9-24
BAS31, 4-1	BZM5223B, 9-13	BZM55C43, 9-15	BZT52C5V6, 9-10	BZX55C39, 9-24
BAS40, 2-1	BZM5224B, 9-13	BZM55C47, 9-15	BZT52C5V6S, 9-5	BZX55C3V0, 9-24
BAS40-04, 2-1	BZM5225B, 9-13	BZM55C4V3, 9-15	BZT52C6V2, 9-10	BZX55C3V3, 9-24
BAS40-05, 2-1	BZM5226B, 9-13	BZM55C4V7, 9-15	BZT52C6V2S, 9-5	BZX55C3V6, 9-24
BAS40-06, 2-1	BZM5227B, 9-13	BZM55C51, 9-15	BZT52C6V8, 9-10	BZX55C3V9, 9-24
BAS40W, 2-2	BZM5228B, 9-13	BZM55C56, 9-15	BZT52C6V8S, 9-5	BZX55C43, 9-24
BAS40W-04, 2-2	BZM5229B, 9-13	BZM55C5V1, 9-15	BZT52C7V5, 9-10	BZX55C47, 9-24
BAS40W-05, 2-2	BZM5230B, 9-13	BZM55C5V6, 9-15	BZT52C7V5S, 9-5	BZX55C4V3, 9-24
BAS40W-06, 2-2	BZM5231B, 9-13	BZM55C62, 9-15	BZT52C8V2, 9-10	BZX55C4V7, 9-24
BAS70, 2-1	BZM5232B, 9-13	BZM55C68, 9-15	BZT52C8V2S, 9-5	BZX55C51, 9-24
BAS70-04, 2-1	BZM5233B, 9-13	BZM55C6V2, 9-15	BZT52C9V1, 9-10	BZX55C56, 9-24
BAS70-05, 2-1	BZM5234B, 9-13	BZM55C6V8, 9-15	BZT52C9V1S, 9-5	BZX55C5V1, 9-24
BAS70-06, 2-1	BZM5235B, 9-13	BZM55C75, 9-15	BZT55C10, 9-16	BZX55C5V6, 9-24
BAS70W, 2-2	BZM5236B, 9-13	BZM55C7V5, 9-15	BZT55C11, 9-16	BZX55C62, 9-24
BAS70W-04, 2-2	BZM5237B, 9-13	BZM55C8V2, 9-15	BZT55C12, 9-16	BZX55C68, 9-24
BAS70W-05, 2-2	BZM5238B, 9-13	BZM55C9V1, 9-15	BZT55C13, 9-16	BZX55C6V2, 9-24
BAS70W-06, 2-2	BZM5239B, 9-13	BZT52C10, 9-10	BZT55C15, 9-16	BZX55C6V8, 9-24
BAT42, 2-3	BZM5240B, 9-13	BZT52C10S, 9-5	BZT55C16, 9-16	BZX55C75, 9-24
BAT42W, 2-1	BZM5241B, 9-13	BZT52C11, 9-10	BZT55C18, 9-16	BZX55C7V5, 9-24
BAT42WS, 2-1	BZM5242B, 9-13	BZT52C11S, 9-5	BZT55C20, 9-16	BZX55C8V2, 9-24
BAT43, 2-3	BZM5243B, 9-13	BZT52C12, 9-10	BZT55C22, 9-16	BZX55C9V1, 9-24
BAT43W, 2-1	BZM5244B, 9-13	BZT52C12S, 9-5	BZT55C24, 9-16	BZX84C10, 9-2
BAT43WS, 2-1	BZM5245B, 9-13	BZT52C13, 9-10	BZT55C27, 9-16	BZX84C10S, 9-3
BAT46, 2-3	BZM5246B, 9-13	BZT52C13S, 9-5	BZT55C2V4, 9-16	BZX84C10W, 9-7
BAT46W, 2-1	BZM5247B, 9-13	BZT52C15, 9-10	BZT55C2V7, 9-16	BZX84C11, 9-2
BAT54, 2-1	BZM5248B, 9-13	BZT52C15S, 9-5	BZT55C30, 9-16	BZX84C11S, 9-3
BAT54A, 2-1	BZM5249B, 9-13	BZT52C16, 9-10	BZT55C33, 9-16	BZX84C11W, 9-7
BAT54AW, 2-2	BZM5250B, 9-13	BZT52C16S, 9-5	BZT55C36, 9-16	BZX84C12, 9-2
BAT54C, 2-1	BZM5251B, 9-13	BZT52C18, 9-10	BZT55C39, 9-16	BZX84C12S, 9-3
BAT54CW, 2-2	BZM5253B, 9-13	BZT52C18S, 9-5	BZT55C3V0, 9-16	BZX84C12W, 9-7
BAT54DW, 2-1	BZM5254B, 9-13	BZT52C20, 9-10	BZT55C3V3, 9-16	BZX84C13, 9-2
BAT54S, 2-1	BZM5255B, 9-13	BZT52C20S, 9-5	BZT55C3V6, 9-16	BZX84C13S, 9-3
BAT54SW, 2-2	BZM5256B, 9-13	BZT52C22, 9-10	BZT55C3V9, 9-16	BZX84C13W, 9-7
BAT54W, 2-2	BZM5257B, 9-14	BZT52C22S, 9-5	BZT55C43, 9-16	BZX84C15, 9-2
BAT54WS, 2-1	BZM5258B, 9-14	BZT52C24, 9-10	BZT55C47, 9-16	BZX84C15S, 9-3
BAV101, 4-3	BZM5259B, 9-14	BZT52C24S, 9-5	BZT55C4V3, 9-16	BZX84C15W, 9-7
BAV102, 4-3	BZM5260B, 9-14	BZT52C27, 9-10	BZT55C4V7, 9-16	BZX84C16, 9-2
BAV103, 4-3	BZM5261B, 9-14	BZT52C27S, 9-5	BZT55C51, 9-16	BZX84C16S, 9-3
BAV16W, 4-2	BZM5262B, 9-14	BZT52C2V7, 9-10	BZT55C56, 9-16	BZX84C16W, 9-7
BAV16WS, 4-2	BZM5263B, 9-14	BZT52C2V7S, 9-5	BZT55C5V1, 9-16	BZX84C18, 9-2
BAV19W, 4-2	BZM5264B, 9-14	BZT52C30, 9-10	BZT55C5V6, 9-16	BZX84C18S, 9-3
BAV19WS, 4-2	BZM5265B, 9-14	BZT52C30S, 9-5	BZT55C62, 9-16	BZX84C18W, 9-7

BZX84C20, 9-2
 BZX84C20S, 9-3
 BZX84C20W, 9-7
 BZX84C22, 9-2
 BZX84C22S, 9-3
 BZX84C22W, 9-7
 BZX84C24, 9-2
 BZX84C24S, 9-3
 BZX84C24W, 9-7
 BZX84C27, 9-2
 BZX84C27S, 9-3
 BZX84C27W, 9-7
 BZX84C2V7, 9-2
 BZX84C2V7S, 9-3
 BZX84C2V7W, 9-7
 BZX84C27, 9-2
 BZX84C30S, 9-3
 BZX84C30W, 9-7
 BZX84C33, 9-2
 BZX84C33S, 9-3
 BZX84C33W, 9-7
 BZX84C36, 9-2
 BZX84C36S, 9-3
 BZX84C36W, 9-7
 BZX84C39, 9-2
 BZX84C39S, 9-3
 BZX84C39W, 9-7
 BZX84C3V0, 9-2
 BZX84C3V0S, 9-3
 BZX84C3V0W, 9-7
 BZX84C3V3, 9-2
 BZX84C3V3S, 9-3
 BZX84C3V3W, 9-7
 BZX84C3V6, 9-2
 BZX84C3V6S, 9-3
 BZX84C3V6W, 9-7
 BZX84C3V9, 9-2
 BZX84C3V9S, 9-3
 BZX84C3V9W, 9-7
 BZX84C43, 9-2
 BZX84C47, 9-2
 BZX84C4V3, 9-2
 BZX84C4V3S, 9-3
 BZX84C4V3W, 9-7
 BZX84C4V7, 9-2
 BZX84C4V7S, 9-3
 BZX84C4V7W, 9-7
 BZX84C51, 9-2
 BZX84C5V1, 9-2
 BZX84C5V1S, 9-3
 BZX84C5V1W, 9-7
 BZX84C5V6, 9-2
 BZX84C5V6S, 9-3
 BZX84C5V6W, 9-7
 BZX84C6V2, 9-2
 BZX84C6V2S, 9-3
 BZX84C6V2W, 9-7
 BZX84C6V8, 9-2
 BZX84C6V8S, 9-3
 BZX84C6V8W, 9-7
 BZX84C7V5, 9-2
 BZX84C7V5S, 9-3
 BZX84C7V5W, 9-7
 BZX84C8V2, 9-2
 BZX84C8V2S, 9-3
 BZX84C8V2W, 9-7
 BZX84C9V1, 9-2
 BZX84C9V1S, 9-3
 BZX84C9V1W, 9-7
 BZX85C10, 9-27
 BZX85C11, 9-27
 BZX85C12, 9-27
 BZX85C13, 9-27
 BZX85C15, 9-27
 BZX85C16, 9-27
 BZX85C18, 9-27
 BZX85C20, 9-27
 BZX85C22, 9-27
 BZX85C24, 9-27
 BZX85C27, 9-27
 BZX85C2V7, 9-27
 BZX85C30, 9-27
 BZX85C33, 9-27
 BZX85C36, 9-27
 BZX85C39, 9-27
 BZX85C3V0, 9-27
 BZX85C3V3, 9-27
 BZX85C3V6, 9-27
 BZX85C3V9, 9-27
 BZX85C43, 9-27
 BZX85C47, 9-27
 BZX85C4V3, 9-27
 BZX85C4V7, 9-27
 BZX85C51, 9-27
 BZX85C56, 9-27
 BZX85C5V1, 9-27
 BZX85C5V6, 9-27
 BZX85C62, 9-27
 BZX85C68, 9-27
 BZX85C6V2, 9-27
 BZX85C6V8, 9-27
 BZX85C75, 9-27
 BZX85C7V5, 9-27
 BZX85C8V2, 9-27
 BZX85C9V1, 9-27
D
 D1G, 7-1
 D2G, 7-1
 D3G, 7-1
 D4G, 7-1
 D5G, 7-1
 D6G, 7-1
 D7G, 7-1
 DF005M, 8-1
 DF005S, 8-1
 DF01M, 8-1
 DF01S, 8-1
 DF02M, 8-1
 DF02S, 8-1
 DF04M, 8-1
 DF04S, 8-1
 DF06M, 8-1
 DF06S, 8-1
 DF08M, 8-1
 DF08S, 8-1
 DF10M, 8-1
 DF10S, 8-1
 DF15005M, 8-1
 DF15005S, 8-1
 DF1501M, 8-1
 DF1501S, 8-1
 DF1502M, 8-1
 DF1502S, 8-1
 DF1504M, 8-1
 DF1504S, 8-1
 DF1506M, 8-1
 DF1506S, 8-1
 DF1508M, 8-1
 DF1508S, 8-1
 DF1510M, 8-1
 DF1510S, 8-1
 DL4001, 7-1
 DL4002, 7-1
 DL4003, 7-1
 DL4004, 7-1
 DL4005, 7-1
 DL4006, 7-1
 DL4007, 7-1
 DL4933, 6-1
 DL4934, 6-1
 DL4935, 6-1
 DL4936, 6-1
 DL4937, 6-1
 DMN100, 11-3
 DZ23C10, 9-9
 DZ23C11, 9-9
 DZ23C12, 9-9
 DZ23C13, 9-9
 DZ23C15, 9-9
 DZ23C16, 9-9
 DZ23C18, 9-9
 DZ23C20, 9-9
 DZ23C22, 9-9
 DZ23C24, 9-9
 DZ23C27, 9-9
 DZ23C2V7, 9-9
 DZ23C30, 9-9
 DZ23C33, 9-9
 DZ23C36, 9-9
 DZ23C39, 9-9
 DZ23C3V0, 9-9
 DZ23C3V3, 9-9
 DZ23C3V6, 9-9
 DZ23C3V9, 9-9
 DZ23C43, 9-9
 DZ23C47, 9-9
 DZ23C4V3, 9-9
 DZ23C4V7, 9-9
 DZ23C51, 9-9
 DZ23C5V1, 9-9
 DZ23C5V6, 9-9
 DZ23C6V2, 9-9
 DZ23C6V8, 9-9
 DZ23C7V5, 9-9
 DZ23C8V2, 9-9
 DZ23C9V1, 9-9
E
 ES1A, 5-1
 ES1B, 5-1
 ES1C, 5-1
 ES1D, 5-1
 ES1G, 5-1
 ES2A, 5-2
 ES2AA, 5-2
 ES2B, 5-2
 ES2BA, 5-2
 ES2C, 5-2
 ES2CA, 5-2
 ES2D, 5-2
 ES2DA, 5-2
 ES3A, 5-3
 ES3AB, 5-3
 ES3B, 5-3
 ES3BB, 5-3
 ES3C, 5-3
 ES3CB, 5-3
 ES3D, 5-3
 ES3DB, 5-3
G
 GBJ10005, 8-5
 GBJ1001, 8-5
 GBJ1002, 8-5
 GBJ1004, 8-5
 GBJ1006, 8-5
 GBJ1008, 8-5
 GBJ1010, 8-5
 GBJ15005, 8-5
 GBJ1501, 8-5
 GBJ1502, 8-5
 GBJ1504, 8-5
 GBJ1506, 8-5
 GBJ1508, 8-5
 GBJ1510, 8-5
 GBJ20005, 8-6
 GBJ2001, 8-6
 GBJ2002, 8-6
 GBJ2004, 8-6
 GBJ2006, 8-6
 GBJ2008, 8-6
 GBJ2010, 8-6
 GBJ25005, 8-6
 GBJ2501, 8-6
 GBJ2502, 8-6
 GBJ2504, 8-6
 GBJ2506, 8-6
 GBJ2508, 8-6
 GBJ2510, 8-6
 GBJ6005, 8-3
 GBJ601, 8-3
 GBJ602, 8-3
 GBJ604, 8-3
 GBJ606, 8-3
 GBJ608, 8-3
 GBJ610, 8-3
 GBJ8005, 8-4
 GBJ801, 8-4
 GBJ802, 8-4
 GBJ804, 8-4
 GBJ806, 8-4
 GBJ808, 8-4
 GBJ810, 8-4
 GBPC15005, 8-5
 GBPC15005W, 8-6
 GBPC1501, 8-5
 GBPC1501W, 8-6
 GBPC1502, 8-5
 GBPC1502W, 8-6
 GBPC1504, 8-5
 GBPC1504W, 8-6
 GBPC1506, 8-5
 GBPC1506W, 8-6
 GBPC1508, 8-5
 GBPC1508W, 8-6
 GBPC1510, 8-5
 GBPC1510W, 8-6
 GBPC25005, 8-6
 GBPC25005W, 8-6
 GBPC2501, 8-6
 GBPC2501W, 8-6
 GBPC2502, 8-6
 GBPC2502W, 8-6
 GBPC2504, 8-6
 GBPC2504W, 8-6
 GBPC2506, 8-6
 GBPC2506W, 8-6
 GBPC2508, 8-6
 GBPC2508W, 8-6
 GBPC2510, 8-6
 GBPC2510W, 8-6
 GBPC35005, 8-7
 GBPC35005W, 8-7
 GBPC3501, 8-7
 GBPC3501W, 8-7
 GBPC3502, 8-7
 GBPC3502W, 8-7
 GBPC3504, 8-7
 GBPC3504W, 8-7
 GBPC3506, 8-7
 GBPC3506W, 8-7
 GBPC3508, 8-7
 GBPC3508W, 8-7
 GBPC3510, 8-7
 GBPC3510W, 8-7
 GBU10005, 8-5
 GBU1001, 8-5
 GBU1002, 8-5
 GBU1004, 8-5
 GBU1006, 8-5
 GBU1008, 8-5
 GBU1010, 8-5
 GBU4005, 8-3
 GBU401, 8-3
 GBU402, 8-3
 GBU404, 8-3
 GBU406, 8-3
 GBU40B, 8-3
 GBU410, 8-3
 GBU6005, 8-4
 GBU601, 8-4
 GBU602, 8-4
 GBU604, 8-4
 GBU606, 8-4
 GBU608, 8-4
 GBU610, 8-4
 GBU8005, 8-4
 GBU801, 8-4
 GBU802, 8-4
 GBU804, 8-4
 GBU806, 8-4
 GBU808, 8-4
 GBU810, 8-4

H
 HD01, 8-1
 HD02, 8-1
 HD04, 8-1
 HD06, 8-1
K
 KBJ4005G, 8-3
 KBJ401G, 8-3
 KBJ402G, 8-3
 KBJ404G, 8-3
 KBJ406G, 8-3
 KBJ408G, 8-3
 KBJ410G, 8-3
 KBJ6005G, 8-3
 KBJ601G, 8-3
 KBJ602G, 8-3
 KBJ604G, 8-3
 KBJ606G, 8-3
 KBJ608G, 8-3
 KBJ610G, 8-3
 KBP005G, 8-2
 KBP01G, 8-2
 KBP02G, 8-2
 KBP04G, 8-2
 KBP06G, 8-2
 KBP08G, 8-2
 KBP10G, 8-2
 KBP2005G, 8-2
 KBP201G, 8-2
 KBP202G, 8-2
 KBP204G, 8-2
 KBP206G, 8-2
 KBP208G, 8-2
 KBP210G, 8-2
L
 LL4148, 4-3
 LL4150, 4-3
 LL4151, 4-3
 LL4154, 4-3
 LL42, 2-3
 LL43, 2-3
 LL4448, 4-3
 LL46, 2-3
 LL5711, 2-3
 LL6263, 2-3
 LLS101A, 2-3
 LLS101B, 2-3
 LLS101C, 2-3
 LLS103A, 2-3
 LLS103B, 2-3
 LLS103C, 2-3
 LS4148, 4-2
 LS4150, 4-2
 LS4151, 4-2
 LS4154, 4-2
 LS4448, 4-2
 LT10A01, 7-5
 LT10A02, 7-5
 LT10A03, 7-5
 LT10A04, 7-5
 LT10A05, 7-5
 LT10A06, 7-5
 LT10A07, 7-5
 LT1501G, 7-3
 LT1502G, 7-3
 LT1503G, 7-3
 LT1504G, 7-3
 LT1505G, 7-3
 LT1506G, 7-3
 LT1507G, 7-3
 LT2A01, 7-4
 LT2A01G, 7-4
 LT2A02, 7-4
 LT2A02G, 7-4
 LT2A03, 7-4
 LT2A03G, 7-4
 LT2A04, 7-4
 LT2A04G, 7-4
 LT2A05, 7-4
 LT2A05G, 7-4
 LT2A06, 7-4
 LT2A06G, 7-4
 LT2A07, 7-4
 LT2A07G, 7-4
 LT6A01, 7-5
 LT6A02, 7-5
 LT6A03, 7-5
 LT6A04, 7-5
 LT6A05, 7-5
 LT6A06, 7-5
 LT6A07, 7-5
M
 MBR10100CT, 3-5
 MBR1030, 3-5
 MBR1030CT, 3-5
 MBR1035, 3-5
 MBR1035CT, 3-5
 MBR1040, 3-5
 MBR1040CT, 3-5
 MBR1045, 3-5
 MBR1045CT, 3-5
 MBR1050, 3-5
 MBR1050CT, 3-5
 MBR1060, 3-5
 MBR1060CT, 3-5
 MBR1070CT, 3-5
 MBR1080CT, 3-5
 MBR1090CT, 3-5
 MBR1530CT, 3-6
 MBR1535CT, 3-6
 MBR1540CT, 3-6
 MBR1545CT, 3-6
 MBR1550CT, 3-6
 MBR1560CT, 3-6
 MBR1630, 3-6
 MBR1635, 3-6
 MBR1640, 3-6
 MBR1640, 3-6
 MBR1645, 3-6
 MBR1650, 3-6
 MBR1650, 3-6
 MBR1660, 3-6
 MBR20100CT, 3-7
 MBR2030CT, 3-7
 MBR2035CT, 3-7
 MBR2040CT, 3-7
 MBR2045CT, 3-7
 MBR2050CT, 3-7
 MBR2060CT, 3-7
 MBR2070CT, 3-7
 MBR2080CT, 3-7
 MBR2090CT, 3-7
 MBR2535CT, 3-8
 MBR2545CT, 3-8
 MBR2550CT, 3-8
 MBR2560CT, 3-8
 MBR3030PT, 3-8
 MBR3035PT, 3-8
 MBR3040PT, 3-8
 MBR3045PT, 3-8
 MBR3050PT, 3-8
 MBR3060PT, 3-8
 MBR4030PT, 3-8
 MBR4035PT, 3-8
 MBR4040PT, 3-8
 MBR4045PT, 3-8
 MBR4050PT, 3-8
 MBR4060PT, 3-8
 MBR6030PT, 3-8
 MBR6035PT, 3-8
 MBR6040PT, 3-8
 MBR6045PT, 3-8
 MBR730, 3-4
 MBR735, 3-4
 MBR740, 3-4
 MBR745, 3-4
 MBR750, 3-4
 MBR760, 3-4
 MBRB1530CT, 3-6
 MBRB1535CT, 3-6
 MBRB1540CT, 3-6
 MBRB1545CT, 3-6
 MBT5551, 11-1
 MCL4148, 4-2
 MCL4151, 4-2
 MCL4154, 4-2
 MCL4448, 4-2
 MMBD4148, 4-1
 MMBD4148W, 4-1
 MMBD4448, 4-1
 MMBD4448W, 4-1
 MMBD7000, 4-1
 MMBD914, 4-1
 MMBF170, 11-3
 MMBT2222A, 11-1
 MMBT2907A, 11-2
 MMBT3904, 11-1
 MMBT3906, 11-2
 MMBT4124, 11-1
 MMBT4126, 11-2
 MMBT4401, 11-1
 MMBT4403, 11-2
 MMBT5401, 11-2
 MMBT6427, 11-2
 MMBTA05, 11-1
 MMBTA06, 11-1
 MMBTA13, 11-2
 MMBTA14, 11-2
 MMBTA42, 11-1
 MMBTA55, 11-2
 MMBTA56, 11-2
 MMBTA63, 11-2
 MMBTA64, 11-2
 MMBTA92, 11-2
 MMBZ5221B, 9-12
 MMBZ5221BS, 9-4
 MMBZ5221BW, 9-8
 MMBZ5222B, 9-12
 MMBZ5222BS, 9-4
 MMBZ5222BW, 9-8
 MMBZ5223B, 9-12
 MMBZ5223BS, 9-4
 MMBZ5223BW, 9-8
 MMBZ5225B, 9-12
 MMBZ5225BS, 9-4
 MMBZ5225BW, 9-8
 MMBZ5226B, 9-12
 MMBZ5226BS, 9-4
 MMBZ5226BW, 9-8
 MMBZ5227B, 9-12
 MMBZ5227BS, 9-4
 MMBZ5227BW, 9-8
 MMBZ5228B, 9-12
 MMBZ5228BS, 9-4
 MMBZ5228BW, 9-8
 MMBZ5229B, 9-12
 MMBZ5229BS, 9-4
 MMBZ5229BW, 9-8
 MMBZ5230B, 9-12
 MMBZ5230BS, 9-4
 MMBZ5230BW, 9-8
 MMBZ5231B, 9-12
 MMBZ5231BS, 9-4
 MMBZ5231BW, 9-8
 MMBZ5232B, 9-12
 MMBZ5232BS, 9-4
 MMBZ5232BW, 9-8
 MMBZ5234B, 9-12
 MMBZ5234BS, 9-4
 MMBZ5234BW, 9-8
 MMBZ5235B, 9-12
 MMBZ5235BS, 9-4
 MMBZ5235BW, 9-8
 MMBZ5236B, 9-12
 MMBZ5236BS, 9-4
 MMBZ5236BW, 9-8
 MMBZ5237B, 9-12
 MMBZ5237BS, 9-4
 MMBZ5237BW, 9-8
 MMBZ5239B, 9-12
 MMBZ5239BS, 9-4
 MMBZ5239BW, 9-8
 MMBZ5240B, 9-12
 MMBZ5240BS, 9-4
 MMBZ5240BW, 9-8
 MMBZ5241B, 9-12
 MMBZ5241BS, 9-4
 MMBZ5241BW, 9-8
 MMBZ5242B, 9-12
 MMBZ5242BS, 9-4
 MMBZ5242BW, 9-8
 MMBZ5243B, 9-12
 MMBZ5243BS, 9-4
 MMBZ5243BW, 9-8
 MMBZ5245B, 9-12
 MMBZ5245BS, 9-4
 MMBZ5245BW, 9-8
 MMBZ5246B, 9-12
 MMBZ5246BS, 9-4
 MMBZ5246BW, 9-8
 MMBZ5248B, 9-12
 MMBZ5248BS, 9-4
 MMBZ5248BW, 9-8
 MMBZ5250B, 9-12
 MMBZ5250BS, 9-4
 MMBZ5250BW, 9-8
 MMBZ5251B, 9-12
 MMBZ5251BS, 9-4
 MMBZ5251BW, 9-8
 MMBZ5252B, 9-12
 MMBZ5252BS, 9-4
 MMBZ5252BW, 9-8
 MMBZ5254B, 9-12
 MMBZ5254BS, 9-4
 MMBZ5254BW, 9-8
 MMBZ5255B, 9-12
 MMBZ5255BS, 9-4
 MMBZ5255BW, 9-8
 MMBZ5256B, 9-12
 MMBZ5256BS, 9-4
 MMBZ5256BW, 9-8
 MMBZ5257B, 9-12
 MMBZ5257BS, 9-4
 MMBZ5257BW, 9-8
 MMBZ5258B, 9-12
 MMBZ5258BS, 9-4
 MMBZ5258BW, 9-8
 MMBZ5259BS, 9-4
 MMBZ5259BW, 9-8
 MMDT2222A, 11-1
 MMDT2227, 11-2
 MMDT2907A, 11-2
 MMDT3904, 11-1
 MMDT3906, 11-2
 MMDT3946, 11-2
 MMDT4401, 11-1
 MMDT4403, 11-2
 MMDT4413, 11-2
 MMST2222A, 11-1
 MMST2907A, 11-1
 MMST3904, 11-1
 MMST3906, 11-1
 MMST4401, 11-1
 MMST4403, 11-1
 MMSZ5221B, 9-11
 MMSZ5221BS, 9-6
 MMSZ5222B, 9-11
 MMSZ5222BS, 9-6
 MMSZ5223B, 9-11
 MMSZ5223BS, 9-6
 MMSZ5225B, 9-11
 MMSZ5225BS, 9-6
 MMSZ5226B, 9-11
 MMSZ5226BS, 9-6
 MMSZ5227B, 9-11
 MMSZ5227BS, 9-6
 MMSZ5228B, 9-11
 MMSZ5228BS, 9-6
 MMSZ5229B, 9-11
 MMSZ5229BS, 9-6
 MMSZ5230B, 9-11
 MMSZ5230BS, 9-6

MMSZ5231B, 9-11
MMSZ5231BS, 9-6
MMSZ5232B, 9-11
MMSZ5232BS, 9-6
MMSZ5234B, 9-11
MMSZ5234BS, 9-6
MMSZ5235B, 9-11
MMSZ5235BS, 9-6
MMSZ5236B, 9-11
MMSZ5236BS, 9-6
MMSZ5237B, 9-11
MMSZ5237BS, 9-6
MMSZ5239B, 9-11
MMSZ5239BS, 9-6
MMSZ5240B, 9-11
MMSZ5240BS, 9-6
MMSZ5241B, 9-11
MMSZ5241BS, 9-6
MMSZ5242B, 9-11
MMSZ5242BS, 9-6
MMSZ5243B, 9-11
MMSZ5243BS, 9-6
MMSZ5245B, 9-11
MMSZ5245BS, 9-6
MMSZ5246B, 9-11
MMSZ5246BS, 9-6
MMSZ5248B, 9-11
MMSZ5248BS, 9-6
MMSZ5250B, 9-11
MMSZ5250BS, 9-6
MMSZ5251B, 9-11
MMSZ5251BS, 9-6
MMSZ5252B, 9-11
MMSZ5252BS, 9-6
MMSZ5254B, 9-11
MMSZ5254BS, 9-6
MMSZ5255B, 9-11
MMSZ5255BS, 9-6
MMSZ5256B, 9-11
MMSZ5256BS, 9-6
MMSZ5257B, 9-11
MMSZ5257BS, 9-6
MMSZ5258B, 9-11
MMSZ5258BS, 9-6
MMSZ5259B, 9-11
MMSZ5259BS, 9-6
MUR140, 5-1
MUR160, 5-1
MURB1610CT, 5-4
MURB1620CT, 5-4
MURS140, 5-2
MURS160, 5-2
N
NPN Section, 11-2
P
P6KE10(C)A, 10-4
P6KE100(C)A, 10-5
P6KE11(C)A, 10-4
P6KE110(C)A, 10-5
P6KE12(C)A, 10-4
P6KE120(C)A, 10-5
P6KE13(C)A, 10-4
P6KE130(C)A, 10-5
P6KE15(C)A, 10-4
P6KE150(C)A, 10-5
P6KE16(C)A, 10-4
P6KE160(C)A, 10-5
P6KE170(C)A, 10-5
P6KE18(C)A, 10-5
P6KE180(C)A, 10-5
P6KE20(C)A, 10-5
P6KE200(C)A, 10-5
P6KE22(C)A, 10-5
P6KE220(C)A, 10-5
P6KE24(C)A, 10-5
P6KE250(C)A, 10-5
P6KE27(C)A, 10-5
P6KE30(C)A, 10-5
P6KE300(C)A, 10-5
P6KE33(C)A, 10-5
P6KE350(C)A, 10-5
P6KE36(C)A, 10-5
P6KE39(C)A, 10-5
P6KE400(C)A, 10-5
P6KE43(C)A, 10-5
P6KE47(C)A, 10-5
P6KE51(C)A, 10-5
P6KE56(C)A, 10-5
P6KE6.8(C)A, 10-4
P6KE62(C)A, 10-5
P6KE68(C)A, 10-5
P6KE7.5(C)A, 10-4
P6KE75(C)A, 10-5
P6KE8.2(C)A, 10-4
P6KE82(C)A, 10-5
P6KE9.1(C)A, 10-4
P6KE91(C)A, 10-5
PBPC1001, 8-5
PBPC1002, 8-5
PBPC1003, 8-5
PBPC1004, 8-5
PBPC1005, 8-5
PBPC1006, 8-5
PBPC1007, 8-5
PBPC301, 8-3
PBPC302, 8-3
PBPC303, 8-3
PBPC304, 8-3
PBPC305, 8-3
PBPC306, 8-3
PBPC307, 8-3
PBPC601, 8-4
PBPC602, 8-4
PBPC603, 8-4
PBPC604, 8-4
PBPC605, 8-4
PBPC606, 8-4
PBPC607, 8-4
PBPC801, 8-4
PBPC802, 8-4
PBPC803, 8-4
PBPC804, 8-4
PBPC805, 8-4
PBPC806, 8-4
PBPC807, 8-4
PNP Section, 11-2
PR1001, 6-2
PR1001G, 6-2
PR1001GL, 6-2
PR1001L, 6-2
PR1002, 6-2
PR1002G, 6-2
PR1002GL, 6-2
PR1002L, 6-2
PR1003, 6-2
PR1003G, 6-2
PR1003GL, 6-2
PR1003L, 6-2
PR1004, 6-2
PR1004G, 6-2
PR1004GL, 6-2
PR1004L, 6-2
PR1005, 6-2
PR1005G, 6-2
PR1005GL, 6-2
PR1005L, 6-2
PR1006G, 6-2
PR1006GL, 6-2
PR1007G, 6-2
PR1007GL, 6-2
PR1501, 6-3
PR1501G, 6-3
PR1501GS, 6-4
PR1501S, 6-4
PR1502, 6-3
PR1502G, 6-3
PR1502GS, 6-4
PR1502S, 6-4
PR1503, 6-3
PR1503G, 6-3
PR1503GS, 6-4
PR1503S, 6-4
PR1504, 6-3
PR1504G, 6-3
PR1504GS, 6-4
PR1504S, 6-4
PR1505, 6-3
PR1505G, 6-3
PR1505GS, 6-4
PR1505S, 6-4
PR1506G, 6-3
PR1506GS, 6-4
PR1507G, 6-3
PR1507GS, 6-4
PR2001, 6-4
PR2001G, 6-4
PR2002, 6-4
PR2002G, 6-4
PR2003, 6-4
PR2003G, 6-4
PR2004, 6-4
PR2004G, 6-4
PR2005, 6-4
PR2005G, 6-4
PR2006G, 6-4
PR2007G, 6-4
PR3001, 6-5
PR3001G, 6-5
PR3002, 6-5
PR3002G, 6-5
PR3003, 6-5
PR3003G, 6-5
PR3004, 6-5
PR3004G, 6-5
PR3005, 6-5
PR3005G, 6-5
PR3006G, 6-5
PR3007G, 6-5
PR6001, 6-5
PR6002, 6-5
PR6003, 6-5
PR6004, 6-5
PR6005, 6-5
R
RS1A, 6-1
RS1AB, 6-1
RS1B, 6-1
RS1BB, 6-1
RS1D, 6-1
RS1DB, 6-1
RS1G, 6-1
RS1GB, 6-1
RS1J, 6-1
RS1JB, 6-1
RS1K, 6-1
RS1KB, 6-1
RS1M, 6-1
RS1MB, 6-1
RS2A, 6-3
RS2AA, 6-3
RS2B, 6-3
RS2BA, 6-3
RS2D, 6-3
RS2DA, 6-3
RS2G, 6-3
RS2GA, 6-3
RS2JA, 6-3
RS2K, 6-3
RS2KA, 6-3
RS2M, 6-3
RS2MA, 6-3
RS3A, 6-5
RS3AB, 6-4
RS3B, 6-5
RS3BB, 6-4
RS3D, 6-5
RS3DB, 6-4
RS3G, 6-5
RS3GB, 6-4
RS3J, 6-5
RS3JB, 6-4
RS3K, 6-5
RS3KB, 6-4
RS3M, 6-5
RS3MB, 6-4
S
S1A, 7-1
S1AB, 7-1
S1B, 7-1
S1BB, 7-1
S1D, 7-1
S1DB, 7-1
S1G, 7-1
S1GB, 7-1
S1J, 7-1
S1JB, 7-1
S1K, 7-1
S1KB, 7-1
S1M, 7-1
S1MB, 7-1
S2A, 7-3
S2AA, 7-2
S2B, 7-3
S2BA, 7-2
S2D, 7-3
S2DA, 7-2
S2G, 7-3
S2GA, 7-2
S2J, 7-3
S2JA, 7-2
S2K, 7-3
S2KA, 7-2
S2M, 7-3
S2MA, 7-2
S3A, 7-4
S3AB, 7-4
S3B, 7-4
S3BB, 7-4
S3D, 7-4
S3DB, 7-4
S3G, 7-4
S3GB, 7-4
S3J, 7-4
S3JB, 7-4
S3K, 7-4
S3KB, 7-4
S3M, 7-4
S3MB, 7-4
S5AC, 7-5
S5BC, 7-5
S5DC, 7-5
S5GC, 7-5
S5JC, 7-5
S5KC, 7-5
S5MC, 7-5
SA10(C)A, 10-2
SA100(C)A, 10-3
SA11(C)A, 10-2
SA110(C)A, 10-3
SA12(C)A, 10-2
SA13(C)A, 10-2
SA14(C)A, 10-2
SA15(C)A, 10-2
SA16(C)A, 10-2
SA17(C)A, 10-2
SA18(C)A, 10-2
SA20(C)A, 10-2
SA22(C)A, 10-2
SA24(C)A, 10-2
SA26(C)A, 10-2
SA28(C)A, 10-2
SA30(C)A, 10-2
SA33(C)A, 10-2
SA36(C)A, 10-2
SA40(C)A, 10-2
SA43(C)A, 10-3
SA45(C)A, 10-3
SA48(C)A, 10-3
SA5.0(C)A, 10-2
SA51(C)A, 10-3
SA54(C)A, 10-3
SA58(C)A, 10-3
SA6.0(C)A, 10-2

SA6.5(C)A, 10-2	SBL1045CT, 3-5	SBL890, 3-4	SMAJ18(C)A, 10-1	SMBJ15(C)A, 10-3
SA60(C)A, 10-3	SBL1050, 3-5	SD101A, 2-3	SMAJ20(C)A, 10-1	SMBJ150(C)A, 10-4
SA64(C)A, 10-3	SBL1050CT, 3-5	SD101AW, 2-3	SMAJ22(C)A, 10-1	SMBJ16(C)A, 10-3
SA7.0(C)A, 10-2	SBL1060, 3-5	SD101AWS, 2-1	SMAJ24(C)A, 10-1	SMBJ160(C)A, 10-4
SA7.5(C)A, 10-2	SBL1060CT, 3-5	SD101B, 2-3	SMAJ26(C)A, 10-1	SMBJ17(C)A, 10-3
SA70(C)A, 10-3	SBL1630, 3-6	SD101BW, 2-3	SMAJ28(C)A, 10-1	SMBJ170(C)A, 10-4
SA75(C)A, 10-3	SBL1630CT, 3-6	SD101BWS, 2-1	SMAJ30(C)A, 10-1	SMBJ18(C)A, 10-3
SA78(C)A, 10-3	SBL1630PT, 3-7	SD101C, 2-3	SMAJ33(C)A, 10-1	SMBJ20(C)A, 10-3
SA8.0(C)A, 10-2	SBL1635, 3-6	SD101CW, 2-3	SMAJ36(C)A, 10-1	SMBJ22(C)A, 10-4
SA8.5(C)A, 10-2	SBL1635CT, 3-6	SD101CWS, 2-1	SMAJ40(C)A, 10-1	SMBJ24(C)A, 10-4
SA85(C)A, 10-3	SBL1635PT, 3-7	SD103A, 2-3	SMAJ43(C)A, 10-1	SMBJ26(C)A, 10-4
SA9.0(C)A, 10-2	SBL1640, 3-6	SD103AW, 2-3	SMAJ45(C)A, 10-1	SMBJ28(C)A, 10-4
SA90(C)A, 10-3	SBL1640CT, 3-6	SD103AWS, 2-1	SMAJ48(C)A, 10-1	SMBJ30(C)A, 10-4
SB1100, 3-2	SBL1640PT, 3-7	SD103B, 2-3	SMAJ5.0(C)A, 10-1	SMBJ33(C)A, 10-4
SB120, 3-2	SBL1645, 3-6	SD103BW, 2-3	SMAJ51(C)A, 10-1	SMBJ36(C)A, 10-4
SB130, 3-2	SBL1645CT, 3-6	SD103BWS, 2-1	SMAJ54(C)A, 10-1	SMBJ40(C)A, 10-4
SB140, 3-2	SBL1645PT, 3-7	SD103C, 2-3	SMAJ58(C)A, 10-1	SMBJ43(C)A, 10-4
SB150, 3-2	SBL1650, 3-6	SD103CW, 2-3	SMAJ6.0(C)A, 10-1	SMBJ45(C)A, 10-4
SB160, 3-2	SBL1650CT, 3-6	SD103CWS, 2-1	SMAJ6.5(C)A, 10-1	SMBJ48(C)A, 10-4
SB170, 3-2	SBL1650PT, 3-7	SD107WS, 2-1	SMAJ60(C)A, 10-1	SMBJ5.0(C)A, 10-3
SB180, 3-2	SBL1660, 3-6	SD830, 3-4	SMAJ64(C)A, 10-1	SMBJ51(C)A, 10-4
SB190, 3-2	SBL1660CT, 3-6	SD840, 3-4	SMAJ7.0(C)A, 10-1	SMBJ54(C)A, 10-4
SB3100, 3-3	SBL1660PT, 3-7	SD845, 3-4	SMAJ7.5(C)A, 10-1	SMBJ58(C)A, 10-4
SB320, 3-3	SBL2030CT, 3-7	SD930, 3-5	SMAJ70(C)A, 10-1	SMBJ6.0(C)A, 10-3
SB330, 3-3	SBL2030PT, 3-7	SD940, 3-5	SMAJ75(C)A, 10-2	SMBJ6.5(C)A, 10-3
SB340, 3-3	SBL2035CT, 3-7	SD945, 3-5	SMAJ78(C)A, 10-2	SMBJ60(C)A, 10-4
SB350, 3-3	SBL2035PT, 3-7	SF10AG, 5-1	SMAJ8.0(C)A, 10-1	SMBJ64(C)A, 10-4
SB360, 3-3	SBL2040CT, 3-7	SF10BG, 5-1	SMAJ8.5(C)A, 10-1	SMBJ7.0(C)A, 10-3
SB370, 3-3	SBL2040PT, 3-7	SF10CG, 5-1	SMAJ85(C)A, 10-2	SMBJ7.5(C)A, 10-3
SB380, 3-3	SBL2045CT, 3-7	SF10DG, 5-1	SMAJ9.0(C)A, 10-1	SMBJ70(C)A, 10-4
SB390, 3-3	SBL2045PT, 3-7	SF10FG, 5-1	SMAJ90(C)A, 10-2	SMBJ75(C)A, 10-4
SB5100, 3-3	SBL2050CT, 3-7	SF10GG, 5-1	SMAZ10, 9-25	SMBJ78(C)A, 10-4
SB520, 3-3	SBL2050PT, 3-7	SF10HG, 5-1	SMAZ12, 9-25	SMBJ8.0(C)A, 10-3
SB530, 3-3	SBL2060CT, 3-7	SF10JG, 5-1	SMAZ15, 9-25	SMBJ8.5(C)A, 10-3
SB540, 3-3	SBL2060PT, 3-7	SF20AG, 5-3	SMAZ16, 9-25	SMBJ85(C)A, 10-4
SB550, 3-3	SBL3030CT, 3-8	SF20BG, 5-3	SMAZ18, 9-25	SMBJ9.0(C)A, 10-3
SB560, 3-3	SBL3030PT, 3-8	SF20CG, 5-3	SMAZ20, 9-25	SMBJ90(C)A, 10-4
SB570, 3-3	SBL3035PT, 3-8	SF20DG, 5-3	SMAZ22, 9-25	SMCJ10(C)A, 10-6
SB580, 3-3	SBL3040CT, 3-8	SF20FG, 5-3	SMAZ24, 9-25	SMCJ100, 10-7
SB590, 3-3	SBL3040PT, 3-8	SF20GG, 5-3	SMAZ27, 9-25	SMCJ11(C)A, 10-6
SBG1025L, 3-5	SBL3045CT, 3-8	SF20HG, 5-3	SMAZ30, 9-25	SMCJ110, 10-7
SBG1030CT, 3-5	SBL3045PT, 3-8	SF20JG, 5-3	SMAZ33, 9-25	SMCJ12(C)A, 10-6
SBG1035CT, 3-5	SBL3050CT, 3-8	SF30AG, 5-4	SMAZ36, 9-25	SMCJ120, 10-7
SBG1040CT, 3-5	SBL3050PT, 3-8	SF30BG, 5-4	SMAZ39, 9-25	SMCJ13(C)A, 10-6
SBG1045CT, 3-5	SBL3060CT, 3-8	SF30CG, 5-4	SMAZ3V3, 9-25	SMCJ130, 10-7
SBG1630CT, 3-6	SBL3060PT, 3-8	SF30DG, 5-4	SMAZ3V6, 9-25	SMCJ14(C)A, 10-6
SBG1635CT, 3-6	SBL530, 3-4	SF30FG, 5-4	SMAZ3V9, 9-25	SMCJ15(C)A, 10-6
SBG1640CT, 3-6	SBL535, 3-4	SF30GG, 5-4	SMAZ4V3, 9-25	SMCJ150, 10-7
SBG1645CT, 3-6	SBL540, 3-4	SF30HG, 5-4	SMAZ4V7, 9-25	SMCJ16(C)A, 10-6
SBG2030CT, 3-7	SBL545, 3-4	SF30JG, 5-4	SMAZ5V1, 9-25	SMCJ160, 10-7
SBG2035CT, 3-7	SBL550, 3-4	SMAJ10(C)A, 10-1	SMAZ5V6, 9-25	SMCJ17(C)A, 10-6
SBG2040CT, 3-7	SBL560, 3-4	SMAJ100(C)A, 10-2	SMAZ6V2, 9-25	SMCJ170, 10-7
SBG2045CT, 3-7	SBL6030PT, 3-8	SMAJ11(C)A, 10-1	SMAZ6V8, 9-25	SMCJ18(C)A, 10-6
SBG3030CT, 3-7	SBL6040PT, 3-8	SMAJ110(C)A, 10-2	SMAZ7V5, 9-25	SMCJ20(C)A, 10-6
SBG3040CT, 3-7	SBL6050PT, 3-8	SMAJ12(C)A, 10-1	SMAZ8V2, 9-25	SMCJ22(C)A, 10-6
SBG3050CT, 3-7	SBL6060PT, 3-8	SMAJ120(C)A, 10-2	SMAZ9V1, 9-25	SMCJ24(C)A, 10-6
SBG3060CT, 3-7	SBL8100, 3-4	SMAJ13(C)A, 10-1	SMBJ10(C)A, 10-3	SMCJ26(C)A, 10-6
SBL1030, 3-5	SBL830, 3-4	SMAJ130(C)A, 10-2	SMBJ100(C)A, 10-4	SMCJ28(C)A, 10-6
SBL1030CT, 3-5	SBL835, 3-4	SMAJ14(C)A, 10-1	SMBJ11(C)A, 10-3	SMCJ30(C)A, 10-6
SBL1035, 3-5	SBL840, 3-4	SMAJ15(C)A, 10-1	SMBJ110(C)A, 10-4	SMCJ33(C)A, 10-6
SBL1035CT, 3-5	SBL845, 3-4	SMAJ150(C)A, 10-2	SMBJ12(C)A, 10-3	SMCJ36(C)A, 10-6
SBL1040, 3-5	SBL850, 3-4	SMAJ16(C)A, 10-1	SMBJ120(C)A, 10-4	SMCJ40(C)A, 10-6
SBL1040CT, 3-5	SBL860, 3-4	SMAJ160(C)A, 10-2	SMBJ13(C)A, 10-3	SMCJ43(C)A, 10-6
SBL1045, 3-5	SBL870, 3-4	SMAJ17(C), 10-1	SMBJ130(C)A, 10-4	SMCJ45(C)A, 10-6
SBL1045, 3-5	SBL880, 3-4	SMAJ170(C)A, 10-2	SMBJ14(C)A, 10-3	SMCJ48(C)A, 10-6

SMCJ5.0(C)A, 10-6
SMCJ51(C)A, 10-6
SMCJ54(C)A, 10-6
SMCJ58(C)A, 10-6
SMCJ6.0(C)A, 10-6
SMCJ6.5(C)A, 10-6
SMCJ60(C)A, 10-6
SMCJ64(C)A, 10-6
SMCJ7.0(C)A, 10-6
SMCJ7.5(C)A, 10-6
SMCJ70(C)A, 10-6
SMCJ75(C)A, 10-6
SMCJ78(C)A, 10-6
SMCJ8.0(C)A, 10-6
SMCJ8.5(C)A, 10-6
SMCJ85(C)A, 10-6
SMCJ9.0(C)A, 10-6
SMCJ90(C)A, 10-6

T

TZQ5221B, 9-17
TZQ5222B, 9-17
TZQ5223B, 9-17
TZQ5224B, 9-17
TZQ5225B, 9-17
TZQ5226B, 9-17
TZQ5227B, 9-17
TZQ5228B, 9-17
TZQ5229B, 9-17
TZQ5230B, 9-17
TZQ5231B, 9-17
TZQ5232B, 9-17
TZQ5233B, 9-17
TZQ5234B, 9-17
TZQ5235B, 9-17
TZQ5236B, 9-17
TZQ5237B, 9-17
TZQ5238B, 9-17
TZQ5239B, 9-17
TZQ5240B, 9-17
TZQ5241B, 9-17
TZQ5242B, 9-17
TZQ5243B, 9-17
TZQ5244B, 9-17
TZQ5245B, 9-17

TZQ5246B, 9-17
TZQ5247B, 9-17
TZQ5248B, 9-17
TZQ5249B, 9-17
TZQ5250B, 9-17
TZQ5251B, 9-17
TZQ5252B, 9-17
TZQ5253B, 9-17
TZQ5254B, 9-17
TZQ5255B, 9-17
TZQ5256B, 9-17
TZQ5257B, 9-17
TZQ5258B, 9-17
TZQ5259B, 9-17
TZQ5260B, 9-18
TZQ5261B, 9-18
TZQ5262B, 9-18
TZQ5263B, 9-18
TZQ5264B, 9-18
TZQ5265B, 9-18
TZQ5266B, 9-18
TZQ5267B, 9-18

U

UF1001, 5-1
UF1002, 5-1
UF1003, 5-1
UF1004, 5-1
UF1005, 5-1
UF1006, 5-1
UF1007, 5-1
UF1501, 5-2
UF1501S, 5-2
UF1502, 5-2
UF1502S, 5-2
UF1503, 5-2
UF1503S, 5-2
UF1504, 5-2
UF1504S, 5-2
UF1505, 5-2
UF1505S, 5-2
UF1506, 5-2
UF1506S, 5-2
UF1507, 5-2
UF1507S, 5-2

UF2001, 5-3
UF2002, 5-3
UF2003, 5-3
UF2004, 5-3
UF2005, 5-3
UF2006, 5-3
UF2007, 5-3
UF3001, 5-4
UF3002, 5-4
UF3003, 5-4
UF3004, 5-4
UF3005, 5-4
UF3006, 5-4
UF3007, 5-4
UG1001, 5-1
UG1002, 5-1
UG1003, 5-1
UG1004, 5-1
UG1005, 5-1
UG2001, 5-3
UG2002, 5-3
UG2003, 5-3
UG2004, 5-3
UG2005, 5-3
UG3001, 5-4
UG3002, 5-4
UG3003, 5-4
UG3004, 5-4
UG3005, 5-4
US1A, 5-1
US1B, 5-1
US1D, 5-1
US1G, 5-1
US1J, 5-1
US1K, 5-1
US1M, 5-1

W

W005G, 8-2
W01G, 8-2
W02G, 8-2
W04G, 8-2
W06G, 8-2
W08G, 8-2
W10G, 8-2

Z

ZMM10, 9-21
ZMM11, 9-21
ZMM12, 9-21
ZMM13, 9-21
ZMM15, 9-21
ZMM16, 9-21
ZMM18, 9-21
ZMM20, 9-21
ZMM22, 9-21
ZMM24, 9-21
ZMM27, 9-21
ZMM2V4, 9-21
ZMM2V7, 9-21
ZMM30, 9-21
ZMM33, 9-21
ZMM36, 9-21
ZMM39, 9-21
ZMM3V0, 9-21
ZMM3V3, 9-21
ZMM3V6, 9-21
ZMM3V9, 9-21
ZMM43, 9-21
ZMM47, 9-21
ZMM4V3, 9-21
ZMM4V7, 9-21
ZMM51, 9-21
ZMM5221B, 9-19
ZMM5222B, 9-19
ZMM5223B, 9-19
ZMM5224B, 9-19
ZMM5225B, 9-19
ZMM5226B, 9-19
ZMM5227B, 9-19
ZMM5228B, 9-19
ZMM5229B, 9-19
ZMM5230B, 9-19
ZMM5231B, 9-19
ZMM5232B, 9-19
ZMM5233B, 9-19
ZMM5234B, 9-19
ZMM5235B, 9-19
ZMM5236B, 9-19
ZMM5237B, 9-19

ZMM5238B, 9-19
ZMM5239B, 9-19
ZMM5240B, 9-19
ZMM5241B, 9-19
ZMM5242B, 9-19
ZMM5243B, 9-19
ZMM5244B, 9-19
ZMM5245B, 9-19
ZMM5246B, 9-19
ZMM5247B, 9-19
ZMM5248B, 9-19
ZMM5249B, 9-19
ZMM5250B, 9-19
ZMM5251B, 9-19
ZMM5252B, 9-19
ZMM5253B, 9-19
ZMM5254B, 9-20
ZMM5255B, 9-20
ZMM5256B, 9-20
ZMM5257B, 9-20
ZMM5258B, 9-20
ZMM5259B, 9-20
ZMM5260B, 9-20
ZMM5261B, 9-20
ZMM5262B, 9-20
ZMM5263B, 9-20
ZMM5264B, 9-20
ZMM5265B, 9-20
ZMM5266B, 9-20
ZMM5267B, 9-20
ZMM56, 9-21
ZMM5V1, 9-21
ZMM5V6, 9-21
ZMM62, 9-21
ZMM68, 9-21
ZMM6V2, 9-21
ZMM6V8, 9-21
ZMM75, 9-21
ZMM7V5, 9-21
ZMM8V2, 9-21
ZMM9V1, 9-21

NOTES

NOTES

NOTES

NOTES

DIODES INCORPORATED

North America

3050 East Hillcrest Drive
Westlake Village, CA 91362-3154
Phone: 805-446-4800
Fax: 805-446-4850

Asia

2nd Fl, 501-15 Chung Cheng Road
Hsin Tien, Taipei
Taiwan, R.O.C.
Phone: 886-2-22-180-116
Fax: 886-2-22-180-119 or 22-180-274

www.diodes.com
www.vishay-liteon.com

DIODES INCORPORATED
DISCRETE SEMICONDUCTORS



DIODES INCORPORATED